



FORLINX
Embedded



SoM



SBC



Embedded computer



web

Vision >>

To be a top supplier of smart device's core platform



17 Years

Since 2006

200+

Employees

26,000+

Business clients

6,000+

Supported developers

1M+ units

Annual SoM output

[PARTENER >>](#)



**GOLD
PARTNER**



[Profile >>](#)

Forlinx Embedded Technology is a well-established and constantly growing company, focused on designing, developing and manufacturing embedded systems solutions. Since 2006, Forlinx has committed to provide user-friendly, cost-efficient, stable and advanced embedded solutions which are based on ARM architecture, and offer a variety of platforms including SOMs (System-on-Module), SBCs (Single Board Computer) and industrial embedded PCs with global logistics support.



Content

NXP

Cortex-A53	SoM FET-MX9352-C.....	6
	SBC OK-MX9252-C.....	7
Cortex-A53	SoM FETMX8MP-C.....	8
	SBC OKMX8MP-C.....	9
	SoM ETMX8MM.....	10
	SBC OKMX8MM-C.....	11
	SoM FETMX8MQ-C.....	12
	SBC OKMX8MQ-C.....	13
Cortex-A9	SoM FETMX6Q/ DL-C.....	14
	SBC OKMX6Q/ DL-C.....	15
	SoM FETMX6Q/ DL-S.....	16
	SBC OKMX6Q/ DL-S3.....	17
Cortex-A7	So.M FETMX6UL-C.....	18
	SBC OK6UL-C.....	19
	SoM FETMX6ULL-S.....	20
	SBC OK6ULL-S.....	21
	SoM FETMX6ULL-C.....	22
	SBC OK6ULL-C.....	23
Cortex-M7	SoM FET1052-C.....	24
	SBC OK1052-C.....	25
	SoM FET1061-S.....	26
	SBC OK1061-S.....	27
Cortex-A72	SoM FET1028A-C.....	28
	SBC OK1028A-C.....	29
	SoM FET1046A-C.....	30
	SBC OK1046A-C2.....	31
Cortex-A53	SoM FET1043A-C.....	32
	SBC OK1043A-C3.....	33
	SoM FET1012A-C.....	34
	SBC OK1012A-C.....	35

Allwinner

Cortex-A7	SoM FETA40i-C.....	36
	SBC OKA40i-C.....	37
	SoM FETT3-C.....	38
	SBC OKT3-C.....	39
Cortex-A53	SoM FETT507-C.....	40
	SBC OKT507-C.....	41

Rockchip

Cortex-A76	SoM FET3588-C.....	42
	SBC OK3588-C.....	43
Cortex-A72	SoM FET3399-C.....	44
	SBC OK3399-C.....	45
Cortex-A55	SoM FET3568-C.....	46
	SBC OK3568-C.....	47

Content

TI	Cortex-A55	SoM FET625x-C48
		SBC OK625x-C49
		FET335x/ OK335x50

Renesas	Cortex-A55	SoM FET-G2L-C.....56
		SBC OK-G2L-C.....57

Embedded computer	FCU models.....58
--------------------------	-------------------



FET-MX9352-C SoM

OVERVIEW



FET-MX9352-C System On Module is powered by NXP i.MX93 series SoC contains powerful dual ARM Cortex-A55 processor runs at up to 1.7GHz and integrated with NPU that accelerates machine learning interface. A general purpose Cortex-M33 runs at up to 250MHz for real time and low lower tasks processing. Robust control networks are possible via CAN-FD. Dual Gigabit Ethernet controllers with one available for TSN driving gateway applications with low latency.

SoM FET-MX9352-C Features

Processor	i.MX 9352	CAN-FD	2, Supports CAN-FD and CAN 2.0B
Architecture	Cortex-A55+ M33	USB	2x USB2.0 controllers integrated with PHY
Frequency	up to 1.7GHz	SD card	1, Complies with SD3.0;
RAM	1GB LPDDR4	SDIO	1, Complies with SDIO3.0
Flash	8GB eMMC	ADC	4, One 12-bit 4-lane 1MS/sADC
OS	Linux5.15.52	SPDIF	1, Supports raw capturing mode
Voltage input	DC5V	PDM	1, 24-bit, supports linear phase response and AOP MIC
Operate Temp	-40°C~ +85°C	UART	8, Baud rate up to 5Mbps
LCD	1, RGB888, up to 1366×768p60 or 1280×800p60	SPI	8, master and slave modes areconfigurable
MIPI-DSI	1x 4-lane MIPI DSI	I2C	8
LVDS	1, Single 4-lane supports 720p60, up to 1366×768p60 or 1280×800p60	I3C	2, Supports 400Kbit/s fast speed mode and 1000Kbit/s enhanced fast speed mode, backward compatible with I2C
SAI	3, Supports frame synchronization, such as I2S,AC97, TDM and codec/ DSP	MIPI-CSI	1, MIPI CSI-2 V1.3/ MIPI D-PHYV1.2;
Ethernet	2x RGMII with one supports TSN;	JTAG	1, For M33 core debugging

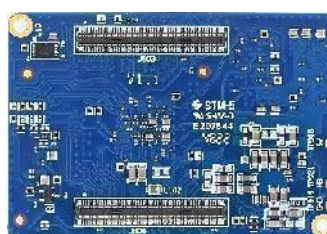

OK-MX9352-C Carrier Board Features

LCD	1, RGB888 24-bit, up to 1366×768p60 or 1280×800p60	LVDS	1, single 8-bit, up to 1366×768p60 or 1280×800p60
MIPI_DSI	1, 4 lanes, up to 1920×1200p60	TF card slot	1, For OS image flashing, SD card 3.0
4G modem	1, Mini-PCIe slot, available for EC20	Ethernet	2x 10M/100M/1000M RJ45 connector, ENET1/ETH1 supports TSN
GPIO	28, pin headers, multiplexed with LCD	ADC	4, 12-bit ADC with sampling rate 1MS/s
CAN-FD	2, with static, surge and pulse protection circuits level 4, and Galvanic isolation complies with CAN2.0B	RS485	2, with static, surge and pulse protection circuits level 4, and Galvanic isolation with automatic transceiving control
USB2.0	2, USB1 by TYPE-C, for OS image flashing; USB2 is expanded from HUB, circuited to 4G, WiFi /BT, USB to 4 serial, and USB-A female connector	UART	2, 3.3V TTL, by pin headers, pitch 2.54mm
WiFi& BT	1, BL-M8723DU, 2.4GWiFi, BT 2.1/4.2	RTC	1, on-board RTC battery holder
Audio	1 four-part phone jack with dual-channel HP and MIC and 2 speaker jacks.	Camera	1, MIPI-CSI, fits OV5645 module
Key	3, reset, power on/ off and user key	LED	1, user defined
GPIO	9xGPIO(3.3V), 5V, 3.3V and 1.8V, by pin headers with pitch of 2.54mm	Debug	1, serial converted to USB for debug, TYPE-C connector
JTAG	1, 10-pin(2×5) headers, pitch 2.0mm		

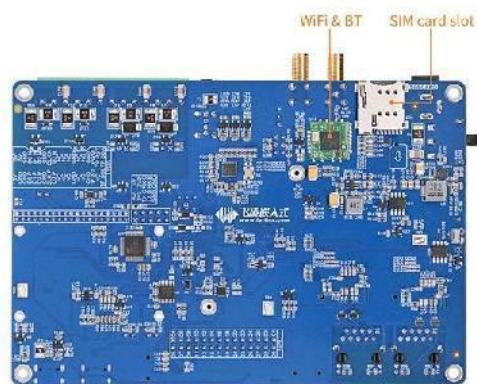
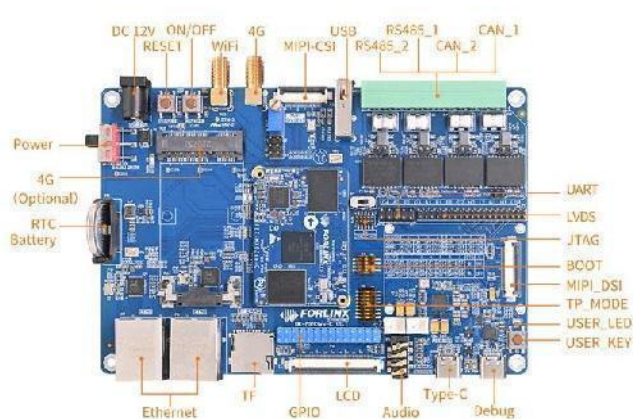



FETMX8MP-C SoM

OVERVIEW



FETMX8MP-C System On Module is based on NXP iMX8M Plus SoC focused on machine learning and vision, advanced multimedia, and industrial automation with high reliability. Powerful quad-core or dual-core Arm® Cortex®-A53 up to 1.6GHz, integrated with NPU up to 2.3 TOPS, two ISP, advanced multimedia performance, a wide range of audio interfaces all-in-one and large set of peripherals. Besides, it contains a Cortex-M7 core for real time tasks processing, Advanced security modules for secure boot, cipher acceleration and DRM support.

SoM FETMX8MP-C Features

CPU	NXP i.MX8M Plus	USB3.0/2.0	2
Architecture	Cortex-A53+ M7	Ethernet	2, one supported with TSN
Frequency	1.6GHz	eMMC5.1	1, up to HS400
RAM	2GB/ 4GB optional	QSPI	≤1
Flash	16GB eMMC	UART	≤4
OS	Linux5.4.7, Android	IIC	≤6, up to 400Kbps
Voltage input	DC5V	PMIC	PCA9450CHN
MIPI-DSI	1, up to 1920x 1080@60Hz	PWM	≤4
LVDS	1, up to 1920x 1080@60Hz	JTAG	supported
HDMI	1, HDMI2.0a, up to 3840x 2160@30Hz	SDIO	1
Camera	2x 4-lane MIPI_CSI	PCIe	1, PCIe Gen3
uSDHC	1	Working Temp	-40°C~ +85°C
Audio	≤6, HiFi4DSP, 6x SAI, supports IIS, AC97, TDM	SPI	≤3, host/ slave optional, up to 52Mbit/s



OKMX8MP-C Carrier Board Features

HDMI	1, HDMI2.0a	PWM	2, for LCD backlight
MIPI_DSI	1, up to 1920x 1080@ 60Hz	IIC	3
LVDS	1, up to 1920x 1080@ 60Hz	UART	4
Camera	2, MIPI_ CSI input, 4-lane	A53 debug	2
Audio	1, 1x Headphone, 1x MIC, 1x Speaker	M7 debug	2
TF card	1, uSDHC, for OS image installation	WiFi& BT	WiFi: IEEE802.11a/b/g/n/ac 2.4-5.8GHz BT5.0
PCIe	1, PCIe Gen3	JTAG	1
USB3.0	2, USB3.0	Key	3, reset, boot, user key
Ethernet	2, 10/ 100/ 1000Mbps, RJ45 connector	RS485	1
LED	2, two dicators for users	CAN FD	2
SPI	1	4G/ 5G	1

■ TARGET APPLICATION

HMI, building security, medical, LPR, printer, UAV, machine vision, aviation and car multimedia.

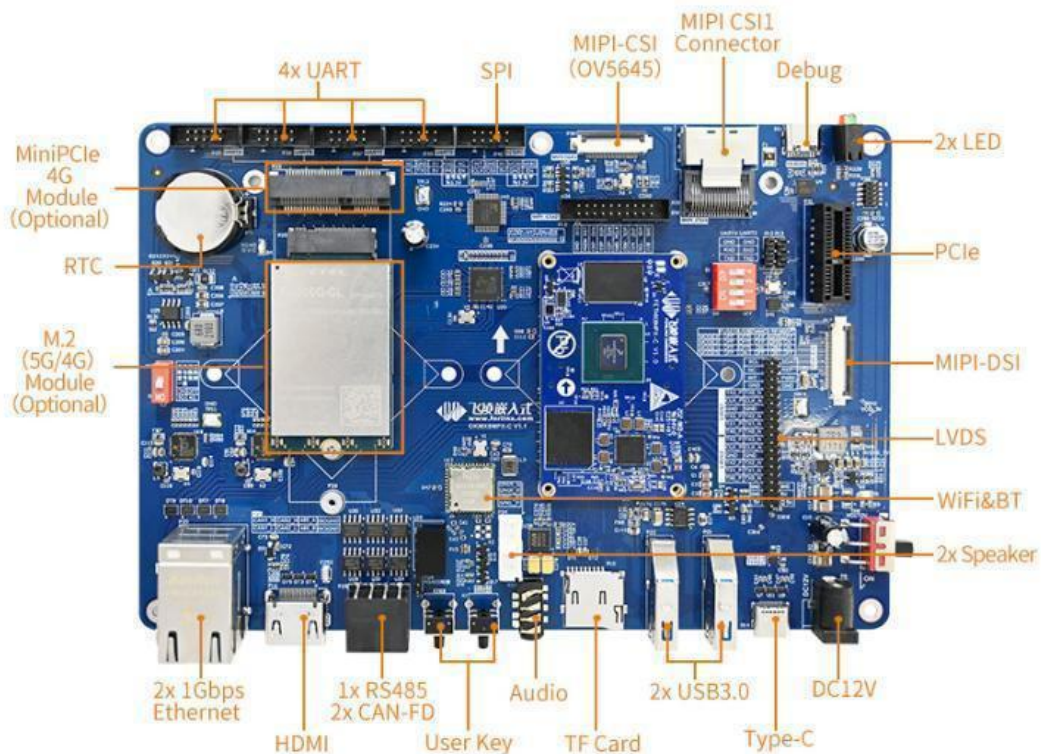



FETMX8MM-C SoM

OVERVIEW



FETMX8MM-C is a system on module designed based on NXP Cortex-A53 featuring quad-core 64-bit processor i.MX8M Mini running speed at up to 1.8GHz, and it can support a Cortex-M4 core@400MHz. It carries 2GB DDR4 and 8GB eMMC on-board.

A wide range of audio interfaces are available, including I2S, AC97, TDM, and S/PDIF. There are a number of other interfaces for connecting peripherals, such as USB, PCIe, and Ethernet.

In software, both Linux 4.14+ QT5.10 and Android 9.0 could be well supported.

SoM FETMX8MM-C Features

CPU	NXP i.MX8M Mini up to 1.8GHz	Display output	1, 4-lane MIPI_DSI
Architecture	Cortex-A53+ M4	SAI	5
RAM	2GB DDR4	UART	4
Flash	8GB eMMC	IIC	4
OS	Linux 4.14.78+ QT5.10, Android 9.0	eCSPI	3
Voltage input	DC5V	FlexSPI	1
Working Temp	0°C~+70°C; -40°C~+85°C	Camera	1, 4-lane MIPI_CSI
Package	thin connector, 3x 80-pin, pitch 0.5mm	SD/ SDIO	2
Dimensions	56x 36mm	USB	2x USB2.0, both are OTG
PMIC	BD71847AMWV-E2	PCe	1x PCIe2.0
GPU	3D:GC NanoUltra; 2D:GC320	PWM	4
Video codec	1080p60 H.265/VP9/H.264/VP8 Decode; 1080P60 AVC/H.264, VP8 encoder	JTAG	1
Ethernet	1, 10M/ 100M/ 1000Mbps adaptive	PDM	1



OKMX8MM-C Carrier Board Features

Display	1, MIPI-DSI	SD/ MMC	1x TF card slot
Audio	1x Phone, 1x MIC, 2x Speaker	SDIO	1
Ethernet	1, 10/ 100/ 1000Mbps, RJ45 connector	USB Host	2, USB2.0
UART	1	USB OTG	1, USB2.0
Debug	1x A53 core debug(RS232) 1x M4 coard debug(UART)	WiFi& BT	WiFi: IEEE802.11b/g/n BT: BTV2.1/BT V3.0/BT V4.0
RS485	1	Mini PCIe	1
IIC	4	PWM	1
SPI	2	JTAG	1
QSPI	1, 16MB QSPI NOR Flash	PDM	1
Camera	1, MIPI-CSI	SAI	1

TARGET APPLICATION

HMI, edge computing, streaming media, printer, medical, machine vision, machine learning, car entertainment.

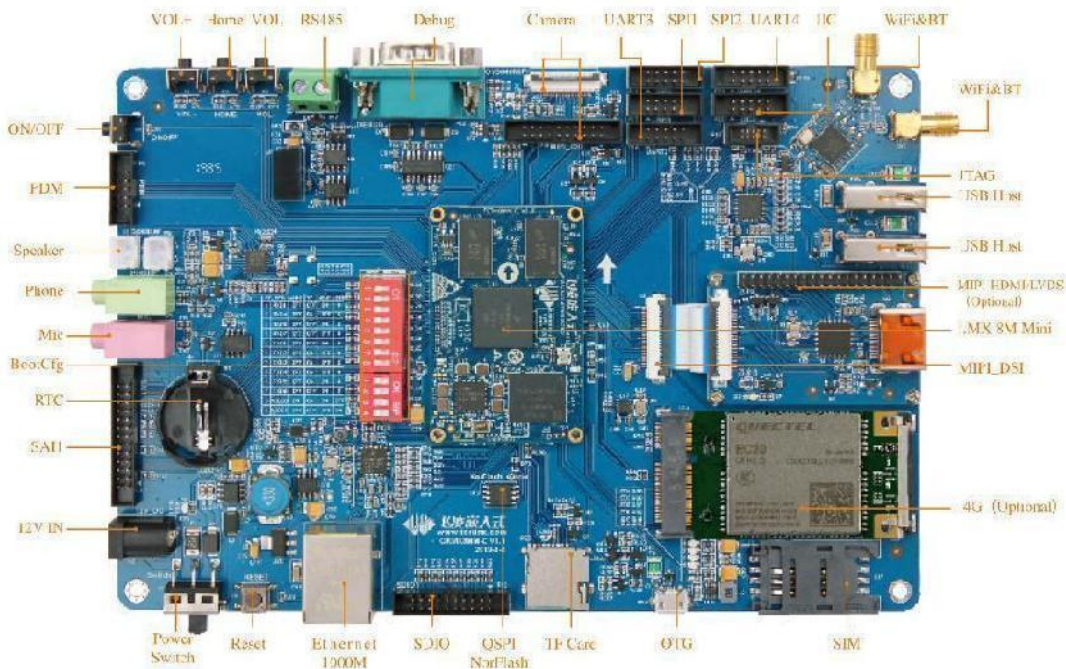



FETMX8MQ-C SoM



OVERVIEW

FETMX8MQ-C system on module is based on NXP i.MX8M Quad SoC integrated with Cortex-A53 core runs speed at up to 1.8GHz and Cortex-M4 core, working temperature ranges from -40°C to 85°C. It's focused on delivering an excellent 4K video and audio experience, combining media-specific features with high-performance processing optimized for low-power consumption.

SoM FETMX8MQ-C Features

CPU	NXP i.MX8M Quad	Display output	1x HDMI(4096x 2160), 1x MIPI-DSI(1366x 768)
Architecture	Cortex-A53+ M4	SAI	4
Frequency	1.3GHz/ 1.5GHz	UART	4
RAM	2GB DDR4	IIC	3
Flash	8GB eMMC	eCSPI	2
OS	Linux5.4.3+ QT5.13.2	Ethernet	1, 10M/ 100M/ 1000Mbps
Voltage input	DC12V	Camera	2x MIPI-CSI
Working Temp	-40°C~ +85°C	SD/ SDIO	1
Package	ultra thin connector	USB3.0	2
Dimensions	40x 64mm	PCIe	2
PMIC	PF4210	PWM	4
GPU	Vivante GC7000-Lite	JTAG	1
Video codec	VP9, H.264, H.265, 4Kp60	GPIO	up to 125



OKMX8MQ-C Carrier Board Features

Display	1x HDMI, 1x MIPI-DSI	PCIe	2, one for hard disk, one for WiFi
Audio	1x Phone, 1x MIC, 1x Speaker	RTC	supported
UART	2	Ethernet	1, 10M/ 100M/ 1000M, RJ45 connector
Debug	1x A53 core debug, 1x M4 core debug	eCSPI	1
IIC	2	4G	1
CAN	1	SAI	2, 1x 8-lane input/ ouput, 1x 1-lane input/output
Camera	2x MIPI-CSI	Key	4x user key, 1x reset, 1x sleeping waken up
USB Host	2 , USB3.0	LED	4
USB OTG	1, USB2.0	SD/ SDIO	1x TF card slot

TARGET APPLICATION

5G, edge computing, HMI, V2X RSU, fuel dispenser, PCR, MTC, medical, power industry , industry automation, smart transportation, environment monitoring, etc.

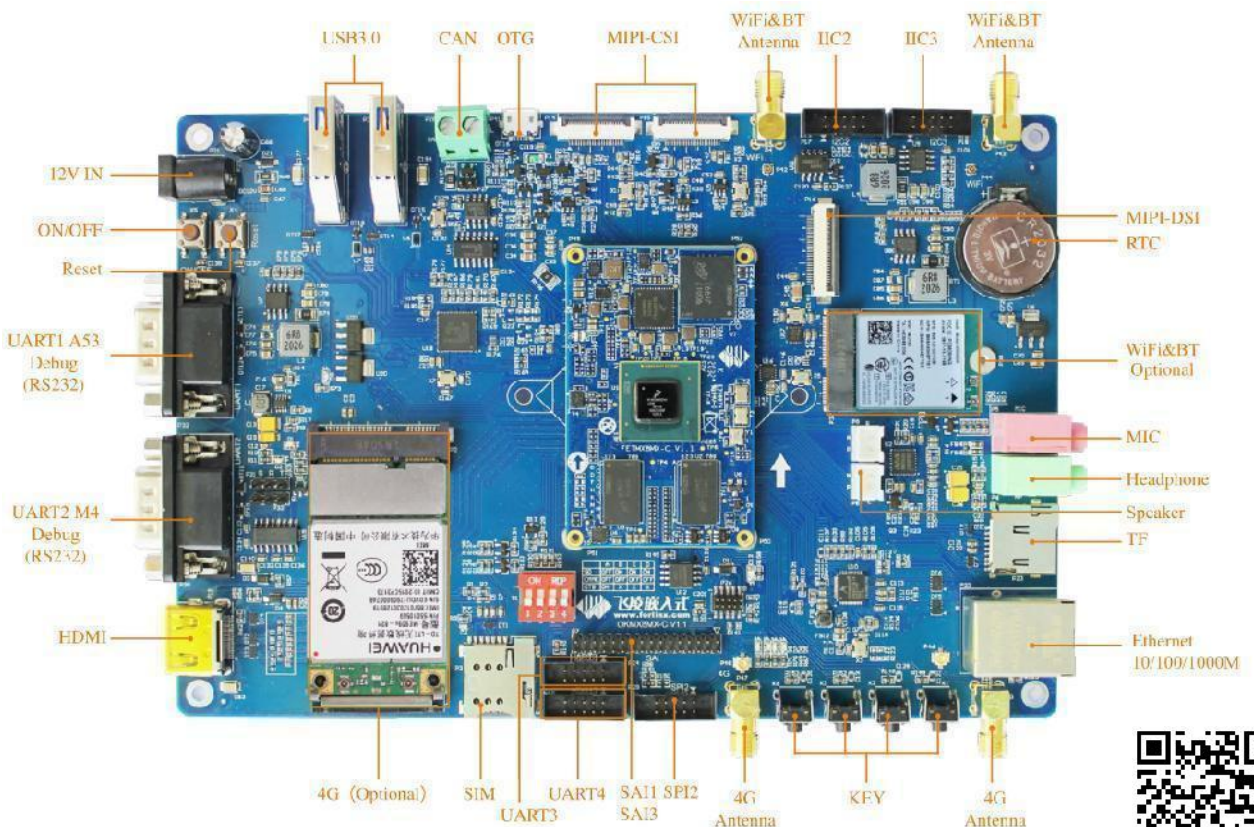



FETMX6Q-C SoM

FETMX6DL-C SoM

OVERVIEW



FETMX6Q-C and FETMX6DL-C are system on modules designed based on NXP/Freescale Cortex-A9 i.MX6Quad and i.MX6DualLite processors with main frequency up to 1.2GHz, this SoM is with 320 pins and it is designed with 12-layer ENIG PCB and ultra thin board-to-board connectors with height only 2mm and golden ratio dimensions of 40*70mm, all of these to make it to be applied more widely.

SoM FETMX6Q-C/ FETMX6DL-C Features

CPU	NXP i.MX6Quad/ i.MX6Dual Lite	UART	5
Architecture	Cortex-A9	CAN	2
Frequency	1.0GHz	IIC	3
RAM	1GB DDR3(2GB optional)	SPI	5
Flash	8GB eMMC	EIM	32-bit data bus, 27-bit address us
OS	Android4.4.2, Android6.0 Linux3.0.35, Linux4.1.15	Camera	1x DVP, 1x MIPI-CSI
Voltage input	4.2V	SD/ MMC/ SDIO	3
Working Temp	0°C~ +70°C; -40°C~ +85°C	USB	1x USB2.0 Host, 1x USB2.0 OTG
Package	ultra thin connector	SATA	1, only available for FETMX6Q-C
Dimensions	40x 70mm	PCIe	1
PMIC	MMPF0100NPEP	PWM	3
GPU	Vivante GC355 / Vivante GC320	MLB	1, Media Local Bus
Video codec	hardware codec	SPDIF	1
Display	1x RGB, 2x 8-bit LVDS, 1x HDMI, 1x MIPI-DSI	JTAG	1
IIS	4	Ethernet	1x 10M/ 100M/ 1000Mbps



OKMX6Q-C/ OKMX6DL-C Carrier Board Features

Display	1xRGB, 2x 8-bit LVDS, 1x MIPI-DSI, 1x HDMI	USB OTG	1, USB2.0
Audio	1x Phone, 1x MIC, 2x Speaker	SATA	1, only for OKMX6Q-C
Mini PCIe	1, for 3G/ 4G connectivity	Ethernet	1, 10M/ 100M/ 1000M, RJ45 connector
UART	4, 3x 3-lane, 1x 5-lane	WiFi& BT	1
RS232	1, debug port	MLB	1
CAN	1	IrDA	1, suspended
IIC	3	RTC	supported
SPI	1	JTAG	supported but suspended
EIM	supported	EINT/GPIO	supported
Camera	1x DVP, 1x MIPI-CSI	Key	4
SD/MMC/SDIO	2	DIP	booting mode selection
USB Host	2, USB2.0	Voltage input	DC5V

TARGET APPLICATION

Car electronics, digital signage, financial device, HMI, in-flight entertainment, industrial control, medical, instrument, smart city, commerce electronics.

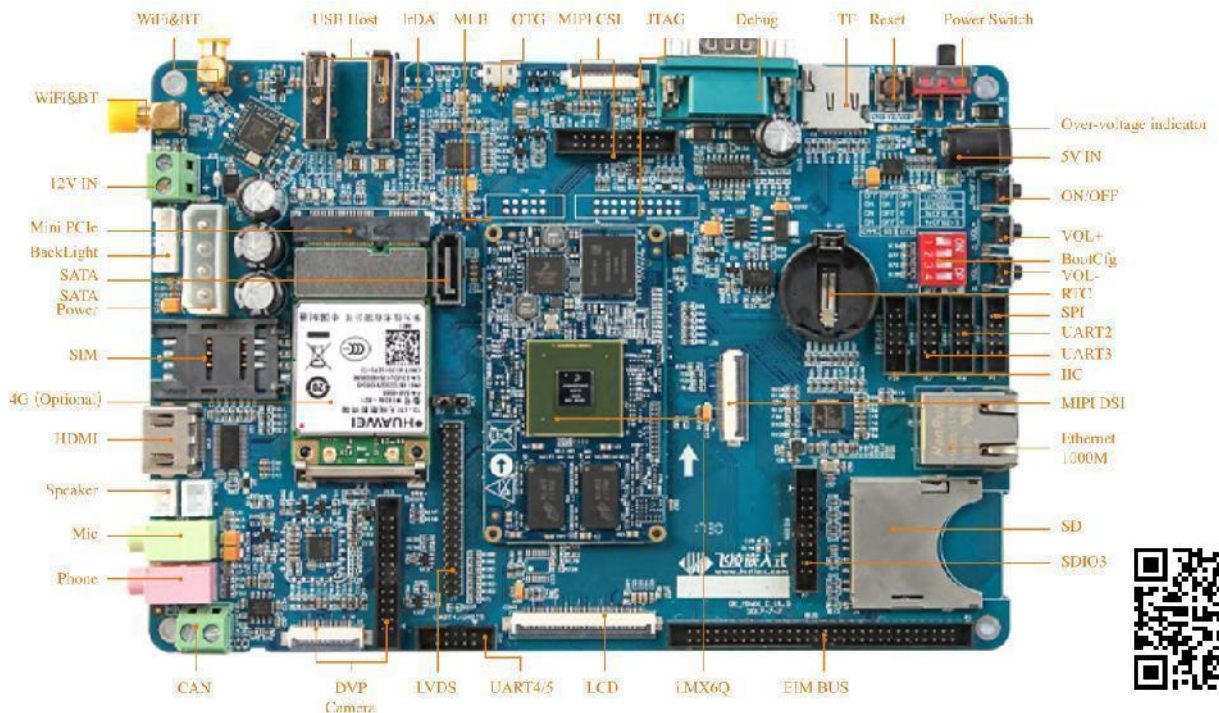



FETMX6Q-S SoM

FETMX6DL-S SoM

OVERVIEW



FETMX6Q-S and FETMX6DL-S system on modules are also based on i.MX6Quad and i.MX6DualLite processors from NXP, the difference is that they could be soldered on carrier board directly but not pluggable.

SoM FETMX6Q-S/ FETMX6DL-S Features

CPU	NXP i.MX6Quad/ i.MX6Dual Lite	Display	1x RGB888, 2x 8-bit LVDS, 1x HDMI
Architecture	Cortex-A9	IIS	1
Frequency	1.0GHz	Ethernet	1x 10M/ 100M/ 1000Mbps
RAM	1GB DDR3(2GB optional)	UART	4
Flash	8GB eMMC	EIM	32-bit data bus, 27-bit address us
OS	Android4.4.2, Android6.0 Linux3.0.35, Linux4.1.15	IIC	3
Voltage input	4.2V	SPI	2
Working Temp	0°C~ +70°C; -40°C~ +85°C	Camera	1x DVP
Package	edge soldering(220 pins, pitch 1mm)	SD/ MMC/ SDIO	2
Dimensions	60x 60mm	USB	1x Host, 1x OTG, USB2.0
PMIC	MMPF0100NPEP	SATA	1, only for FETMX6Q-S
GPU	Vivante GC355 / Vivante GC320	PCIe	1
Video codec	hardware codec	EINT/ GPIO	supported



OKMX6Q-S3/ OKMX6DL-S3 Carrier Board Features

Display	1xRGB888, 2x 8-bit LVDS, 1x HDMI	USB Host	2, USB2.0
Audio	1x Phone, 1x MIC, 2x Speaker	USB OTG	1, USB2.0
Ethernet	1, 10M/ 100M/ 1000M, RJ45 connector	SATA	1, only for OKMX6Q-C
UART	3, 2x 3-lane, 1x 5-lane	Mini PCIe	1, for 3G/ 4G connectivity
RS232	1, debug port	WiFi& BT	1
CAN	1	RTC	supported
IIC	3	EINT/GPIO	supported
SPI	1	Keys	4
Camera	1x DVP	DIP	booting mode selection
SD/MMC/SDIO	2	Voltage input	DC5V

TARGET APPLICATION

Car electronics, digital signage, financial device, HMI, in-flight entertainment, industrial control, medical, instrument, smart city, commerce electronics.

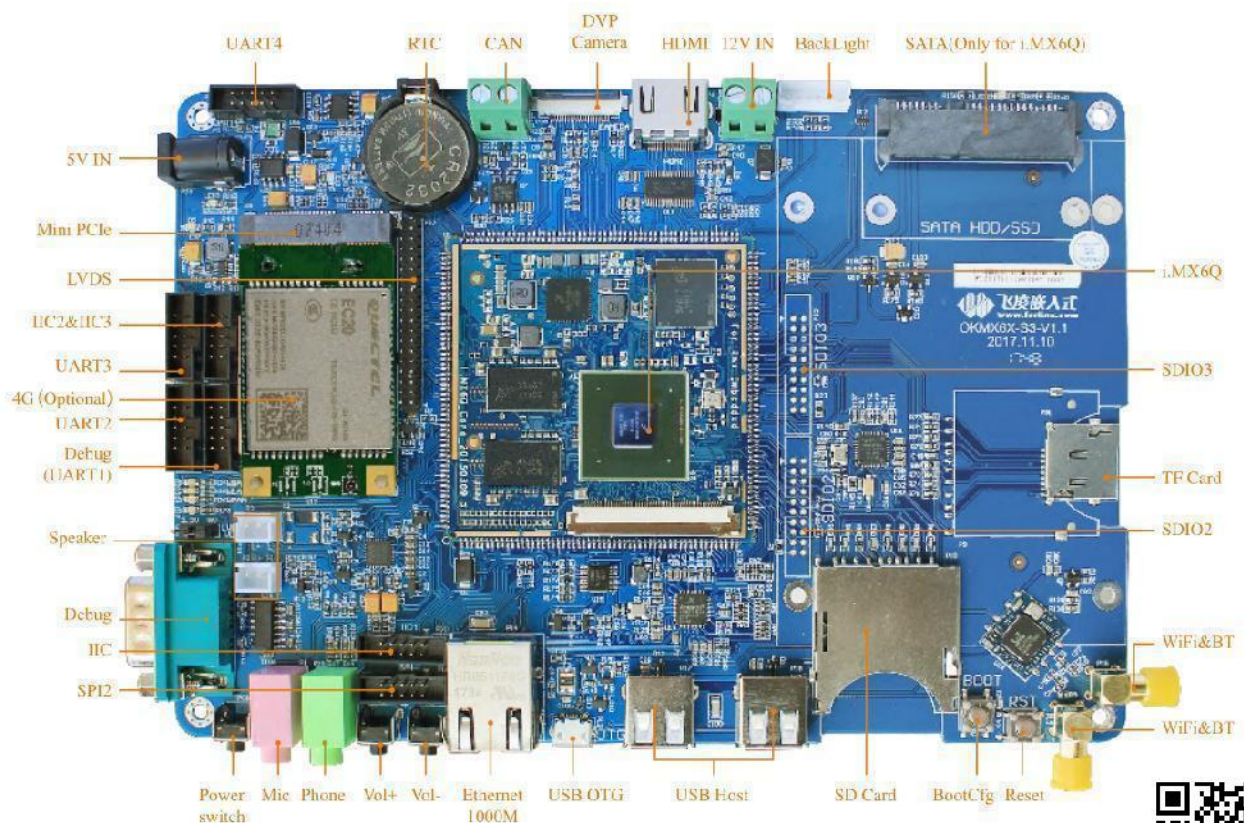



FETMX6UL-C SoM

OVERVIEW



FETMX6UL-C system on module is based on NXP Cortex-A7 featuring CPU i.MX6UltraLite with frequency of 528MHz. The SoM has two 80-pin connectors for connection with carrier board and unique PMU make it even lower power than ARM9. It has a variety of hardware sources can support up to 8 UART, 2 Ethernet ports, 2 CAN and other interface. Both commercial grade and industrial grade are optional. 512MB RAM and 4GB eMMC for the commercial grade one, and 256M RAM 256M NAND Flash for the industrial grade one.

SoM FETMX6UL-C Features

CPU	NXP i.MX6Ultra Lite	CAN	2
Architecture	Cortex-A7	IIC	4
Frequency	528MHz	SPI	4
RAM	256MB, 512MB	EIM	16-bit data bus, 16-bit address us
Flash	256MB NAND Flash, 8GB eMMC	Camera	1x DVP
OS	Linux3.14.38, Linux4.1.15	SD/ MMC/ SDIO	2
Voltage input	5V	USB	2x USB2.0 OTG
Working Temp	-40°C~ +85°C; 0°C~ +70°C	PWM	8
Package	2x 80-pin connector, pitch 0.8mm	SPDIF	1
Dimensions	40x 50mm	JTAG	1
Video codec	software codec	EINT/ GPIO	supported
Display	1x RGB888	Keypad	1, 8x8 keypad
IIS	3	ADC	10
Ethernet	2x 10M/ 100Mbps, RJ45 connector	QSPI	1
UART	8	ISO7816-3	2



eMMC version



NAND Flash version



OKMX6UL-C Carrier Board Features

Display	1xRGB888	WiFi& BT	1
Audio	1x Phone, 1x MIC, 2x Speaker	ADC	4, for resistive touching
Ethernet	2, 10M/ 100Mbps	ESAM/PSAM	1, multiplexed with camera
UART	2x 5-lane	RTC	supported
RS232	1, debug port	JTAG	1
CAN	2	EINT/GPIO	supported
IIC	2	Keys	1
Camera	1x DVP	DIP	booting mode selection
SD/MMC/SDIO	1, SDIO is multiplexed with SD card	LED	2
USB	3x USB2.0 Host, 1x USB2.0 OTG	Voltage input	DC5V

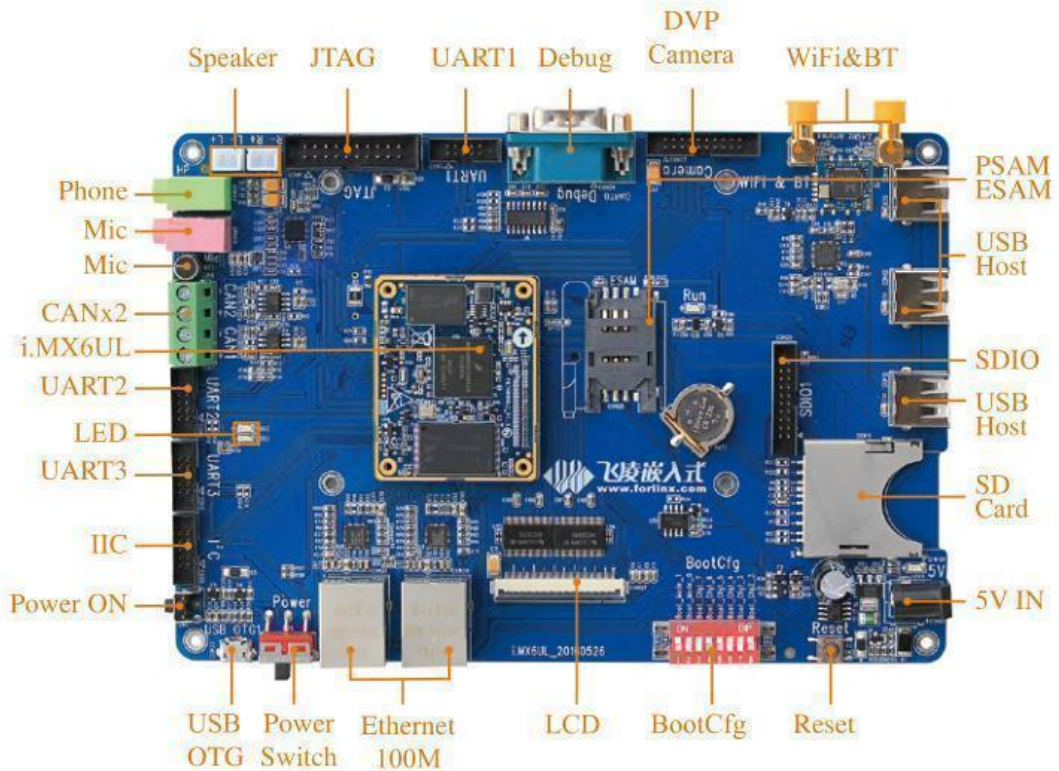



FETMX6ULL-S SoM

OVERVIEW



FETMX6ULx-S system on module is designed based on NXP Cortex-A7 featuring CPU i.MX6ULL processor. It runs at 800MHz, and SoM can be soldered on carrier board. It can support 8x UART, 2x Ethernet, 2x CAN and other peripheral sources.

SoM FETMX6ULL-S Features

CPU	NXP i.MX6ULL	UART	≤8, each up to 5.0Mbps
Architecture	Cortex-A7	eCSPI	≤4, host/ slave mode optional
Frequency	800MHz	IIC	≤4
RAM	256MB, 512MB	Camera	1x 8-bit DVP
Flash	256MB NAND Flash, 8GB eMMC	SD/ MMC/ SDIO	≤2, 1-bit or 4-bit modem
OS	Linux4.1.15+ QT5.6	USB	2, USB2.0
Voltage input	5V	Ethernet	≤2, 10M/ 100Mbps
Working Temp	-25°C~ +85°C; -40°C~ +85°C	Package	edge soldering
Dimensions	44x 35mm	PWM	≤8, 16-bit
LCD	RGB888, up to 1366* 768@ 60Hz	ADC	≤10, 12-bit
SAI	≤3, IIS	SPDIF	1



eMMC version



NAND Flash version



OKMX6ULL-S Carrier Board Features

Display	1xRGB888	UART	4, 3x TTL for general purpose, 1x debug
Audio	1x Phone, 1x MIC, 2x Speaker	SDIO	1
Ethernet	1, 10M/ 100M/ 1000M, RJ45 connector	SD	1
CAN	2x CAN2.0B	LED	2
USB Host	3, expanded by HUB	IIC	2
USB OTG	1	Camera	1x 8-bit DVP
WiFi& BT	WiFi: IEEE802.11b/g/n; BT: BTV2.1/BT V3.0/BT V4.0	RTC	supported

TARGET APPLICATION

IoT, power industry, medical, environment monitoring, smart city, smart agriculture, industrial control, HMI, financial, EV charger, etc.

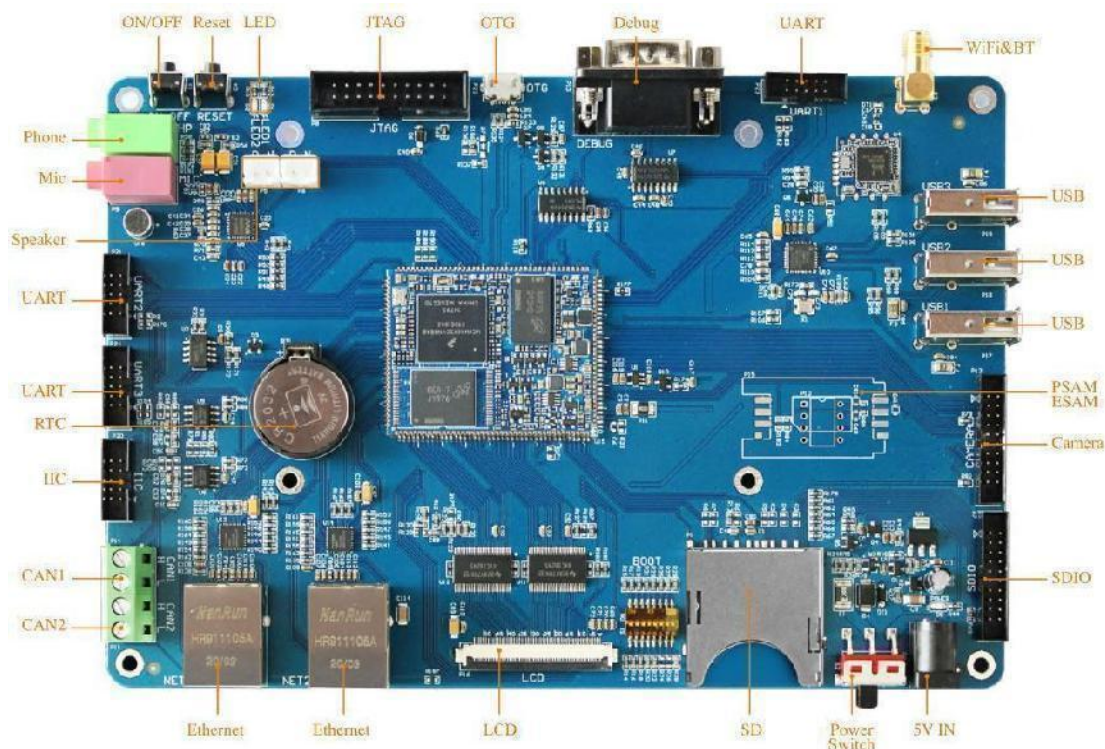



FETMX6ULL-C SoM

OVERVIEW



FETMX6ULL-C system on module is designed based on NXP Cortex-A7 featuring CPU i.MX6ULL processor. It runs at 800MHz, and the SoM is compact but powerful. It can support 8x UART, 2x Ethernet, 2x CAN, 2x USB2.0, LCD and other peripheral sources.

SoM FETMX6ULL-C Features

CPU	NXP i.MX6ULL	UART/IrDA	8
Architecture	Cortex-A7	SPI	4
Frequency	800MHz	IIC	4
RAM	512MB DDR3	CAN	2
Flash	8GB eMMC	USB	2, USB2.0
OS	Linux4.1.15+ QT5.6	SD/ MMC/ SDIO	2
Voltage input	3.3V	Ethernet	2, 10M/ 100Mbps
Working Temp	-40°C~ +85°C	ADC	10
Dimensions	40x 29mm	eSAI	1
Package	2x 80-pin connector, pitch 0.5mm	KeyPad	8* 8
LCD	RGB888, up to WXGA 1366* 768	QSPI	1
Audio	3	SPDIF	1

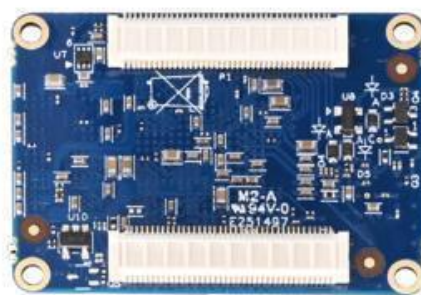

OKMX6ULL-C Carrier Board Features

CAN	2x CAN2.0B	USB OTG	1x USB Type-C
LED	3, power, user, 4G	SD	1x TF card slot
Audio	1x Phone, 1x MIC, 1x Speaker	UART	4, 3.3V, pin headers with pitch of 2.5mm
RTC	supported	IIC	2, 3.3V, pin headers with pitch of 2.5mm
Power input	DC5V	SPI	2, 3.3V, pin headers with pitch of 2.5mm

TARGET APPLICATION

IoT, power industry, medical, environment monitoring, smart city, smart agriculture, industrial control, HMI, financial, EV charger, etc.

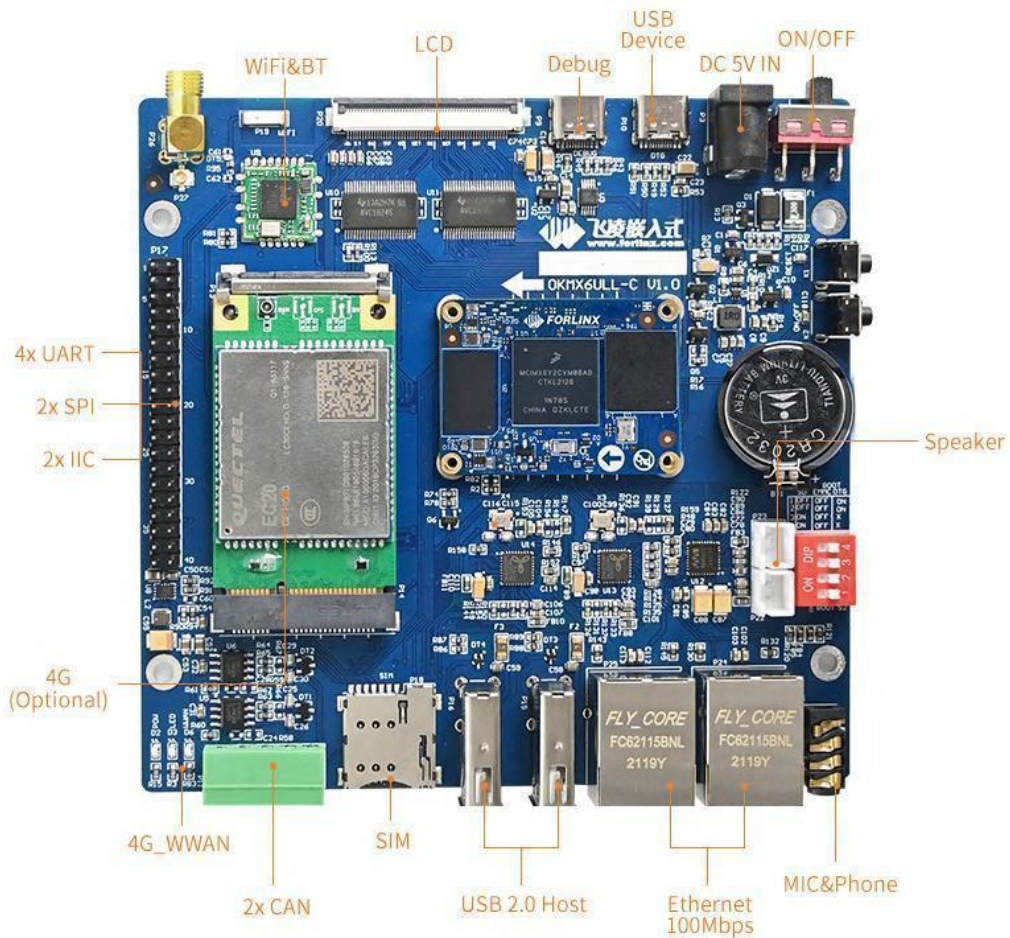



FET1052-C SoM

OVERVIEW



FET1052-C system on module is based on NXP Cortex-M7 i.MX RT1050 series processor, the one we use is i.MX RT1052. It operates at speeds up to 528MHz to provide high CPU performance and best real-time response. The i.MX RT1052 processor has 512 KB on-chip RAM, which can be flexibly configured as TCM or general-purpose on-chip RAM. The SoM can work stable in environment ranges from -40 to +85 celsius degree, the SoM is designed with a couple of 80-pin connectors with pitch of 0.8mm, all 160 pins of the processor are drawn out with GPIO up to 124 pins. Other peripheral pins like UART, Ethernet, USB, CAN, PWM, ADC, LCD and CAMERA are all available. What's more, OS uClinux is supported very well.

SoM FET1052-C Features

CPU	NXP i.MX RT1052	UART	8
Architecture	Cortex-M7	CAN	2
Frequency	528MHz	IIC	4
RAM	SRAM 512KB;SDRAM 16MB/32MB	Camera	1x DVP
Flash	QSPI Nor Flash 4MB/16MB	SD/ MMC/ SDIO	2
OS	uClinux, FreeRTOS, RT-Thread, bare metal	SPI	4
Voltage input	5V	Ethernet	1, 10M/ 100Mbps
Working Temp	-40°C~ +85°C	Package	2x 80-pin connector, pitch 0.8mm
Dimensions	44x 35mm	PWM	32
USB	2	SWD	1
Keypad	1, 8* 8 keypad	QSPI	2
Display	1x RGB888	ADC	20
SAI	3	SPDIF	1



OK1052-C Carrier Board Features

Display	1xRGB888	USB OTG	1, USB2.0
Audio	1x Phone, 1x MIC	ADC	5(4* resistive touching, 1 resistor)
Ethernet	1, 10M/ 100M/ 1000M, RJ45 connector	PWM	1, backlight
UART	1x 3-lane serial	RTC	RX8010+CR1220
RS232	1x debug	SWD	1
CAN	1	Functional key	reset, waken up, boot key
IIC	1	DIP	1
SPI	1	LED	1
Camera	1x DVP	Keypad	1, 4*4 keypad
TF card slot	1	EEPROM	1, 256 bytes
USB Host	1, USB	Power in	DC5V

TARGET APPLICATION

UAV, HMI, PLC, motor control, motion control, robotic, smart lighting, solar converter, power system control, conditioner, concentrator

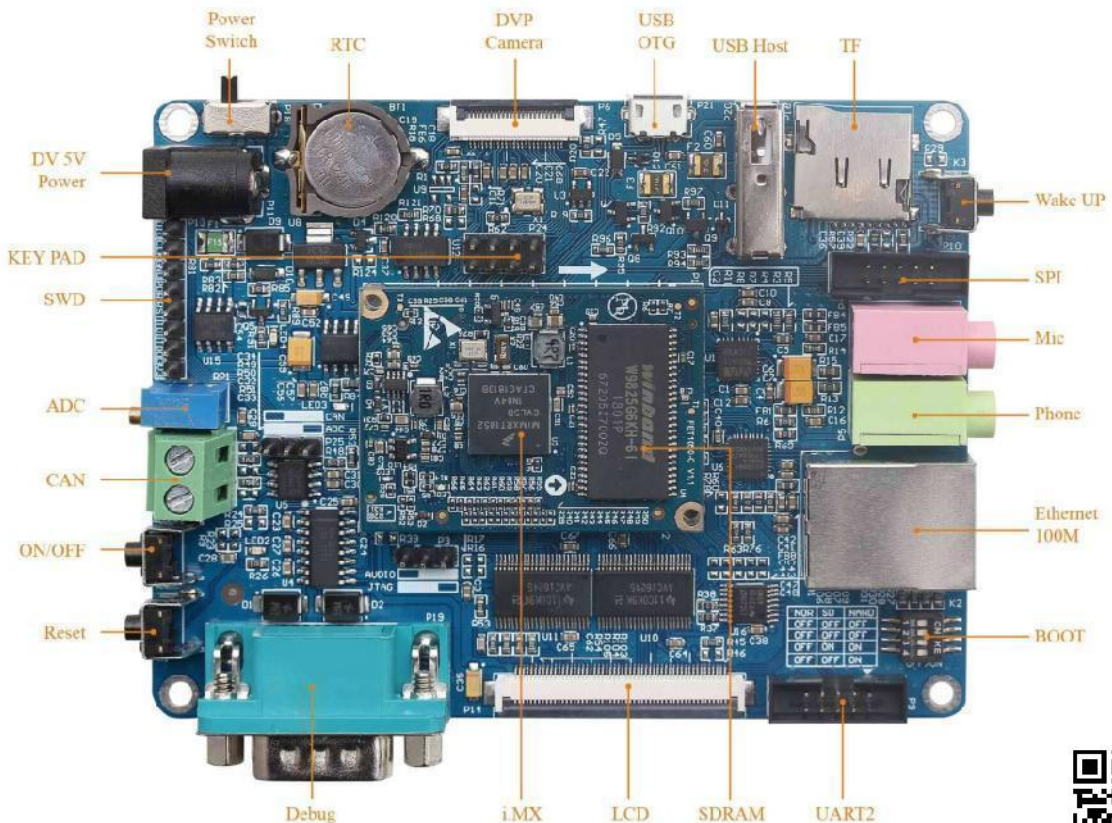



FET1061-S SoM

OVERVIEW



FET1061-S system on module is based on NXP Cortex-M7 MCU i.MX RT1061@ 528MHz, it has on-chip SRAM up to 1MB, 512KB can be flexibly configured as TCM or general purposes on-chip RAM, and it can support QSPI-NOR Flash of 4MB. It has a compact volume of 30x 30x 3mm, 100 pins are available with pitch of 1.0mm. It integrates HS_GPIO, CAN-FD and NAND/NOR/PSRAM controllers. The SoM temp width ranges from -40 to +85 degree. Meanwhile, various peripheral interface such as UART, 2x Ethernet, USB, CAN, CAN-FD, HS_GPIO and PWM, ADC are available. Bare metal and FreeRTOS are both supported.

SoM FET1061-S Features

CPU	NXP i.MX RT1061	CAN	2
Architecture	Cortex-M7	IIC	4
Frequency	528MHz	SPI	3
RAM	1MB On Chip SRAM	SD/ SDIO	2
Flash	QSPI Nor Flash 4MB/16MB	USB	2
OS	FreeRTOS, RT-Thread, bare metal	PWM	26
Voltage input	5V	Ethernet	2, 10M/ 100Mbps
Working Temp	-40°C~ +85°C	Package	edge soldering
Dimensions	30x 30mm	SPDIF	1
ADC	10	SWD	1
SAI	2	QSPI	1
CAN FD	1	ADC	20
UART	7	HS-GPIO	32



OK1061-S Carrier Board Features

Audio	1x Phone, 1x MIC	ADC	5(4* resistive touching, 1 resistor)
Ethernet	2, 10M/ 100M/ 1000M, RJ45 connector	PWM	1, backlight
UART	1x 3-lane serial	RTC	RX8010+CR1220
RS232	1x debug	SWD	1
CAN	1	Functional key	reset, waken up, boot key
IIC	1	DIP	1
SPI	1	LED	1
TF card slot	1	Keypad	1, 4*4 keypad
USB Host	1, USB2.0	EEPROM	1, 256 bytes
USB OTG	1, USB2.0	Power in	DC5V

TARGET APPLICATION

UAV, HMI, PLC, motor control, motion control, robotic, smart lighting, solar converter, power system control, conditioner, concentrator

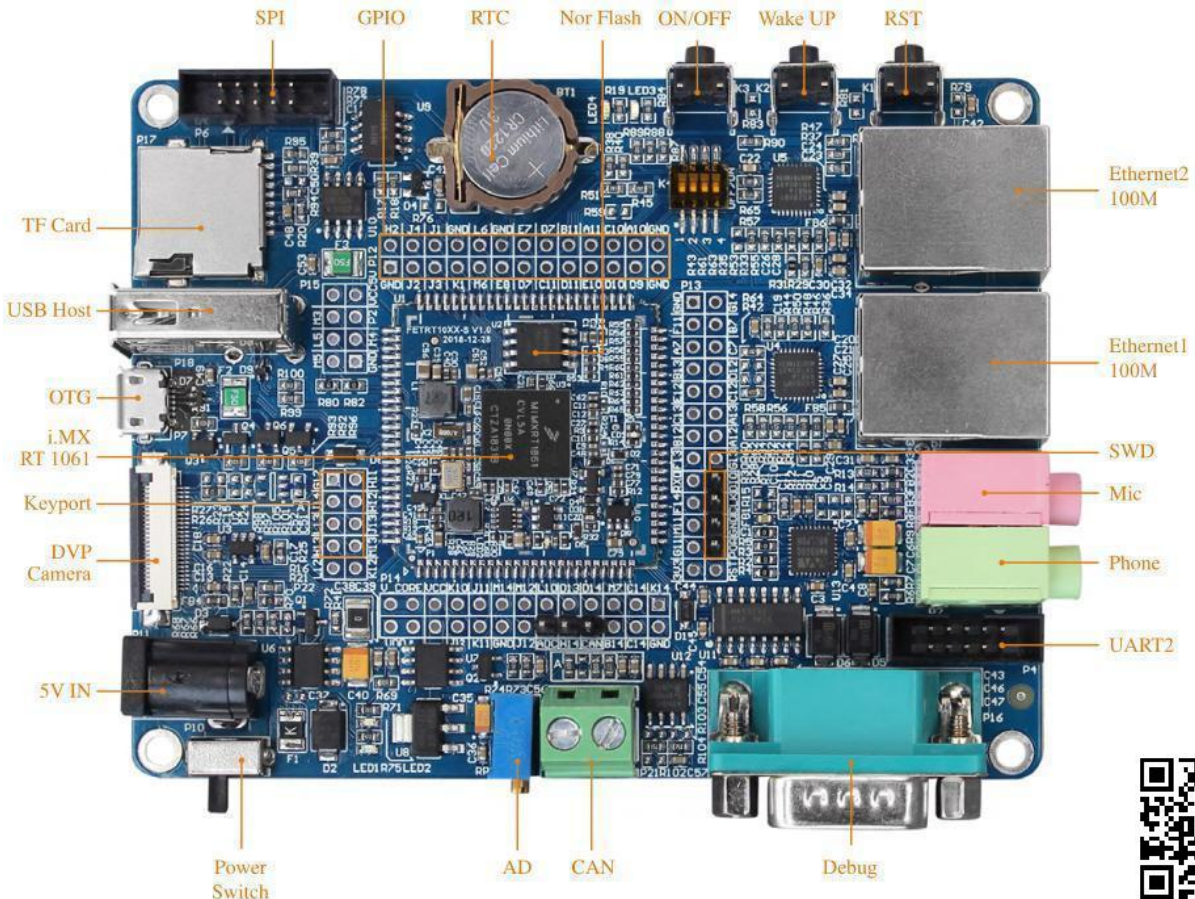



FET1028A-C SoM

OVERVIEW



FET1028A-C SoM(system on module) is based on Cortex-A72 featuring dual-core processor LS1028A up to 1.5G Hz. It carries on-board 2GB DDR4 RAM and 8GB eMMC, can support 6 Gigabit Ethernet ports with TSN, 2 CAN-FD, USB3.0, UART, SPI, IIC, LVDS, TF card slot, SATA3.0, Headphone peripheral sources, DP can support 4K display output. It could be widely used into industrial router, TSN, SD-WAN, 5G CPE, edge computing, IP-PBX, IoT, smart transportation, power management and other related applications.

SoM FET1028A-C Features

CPU	NXP LS1028A	eSDHC	≤1, SD3.0
Architecture	Cortex-A72	Ethernet	≤6, CPU has 6 native MAC each up to 2.5Gbps, can support TAN, and one has 4-lane TSN switch
Frequency	1.5GHz	PCIe3.0	≤2, up to 8GT/s, SerDes configurable
RAM	2GB DDR4	SATA3.0	≤1, up to 6Gbps, SerDes configurable
Flash	8GB eMMC	USB3.0	≤2, up to 5Gbps
OS	Ubuntu18.04	UART	≤4, 1x DUART or 4x UART
Voltage input	DC12V	CAN FD	≤2
Working Temp	-40°C~ +85°C	IIC	≤6
Dimensions	42x 65mm	SPI	≤2
Package	2x 80-pin connector, pitch 0.5mm	IIS	≤6
Display	≤1, DP1.3 and eDP1.4, up to 4Kp60		
SerDes	1x 4-lane SerDes, combinations of SGMII, QSGMII, PCIe and SATA are configurable; frequently combinations: A. SGMII+QSGMII+PCIe2.0 x1+SATA3.0 B. PCIe3.0 x1+QSGMII+PCIe3.0 x2 C. SGMII+QSGMII+PCIe3.0 x2 D. PCIe3.0 x2+ E. SGMII+QSGMII+PCIe3.0 x1+PCIe3.0 x1 F. PCIe3.0 x4		



OK1028A-C Carrier Board Features

Ethernet	5, RJ45 connector, 10M/ 100M/ 1000Mbps, all support TSN	UART	1, 3-wire serial, 3.3V
USB Host	1, USB3.0, Super-speed(5 Gbit/s)	CAN	2, CAN2.0B and CAN FD, 5Mbit/s
LVDS	1, single 8-bit or dual 8-bit LVDS	SPI	1, full duplex, host/ slave mode optional
Audio	1, 1x Phone, 1x Speaker	IIC	2, 100/ 400Kbps
PCie	1, M.2 key E socket, PCIe Gen2, available for 2.4G and 5G WiFi module	TF card slot	1, compatible with SD3.0(UHS-I)
SATA	1, SATA3.0, 1.5Gb/s~ 6.0Gb/s	LED	2, programmable, controlled by GPIO
4G	1, Mini PCIe socket, optional with 5G	PWM	1, for LVDS display backlight
5G	1, M.2 key B socket, optional with 4G	Debug	1, RS232, DB9 connector

TARGET APPLICATION

Industrial IoT, TSN, SD-WAN, 5G CPE, edge computing, gateway, IP-PBX, smart factory, information security, intelligent transport, power management, etc.

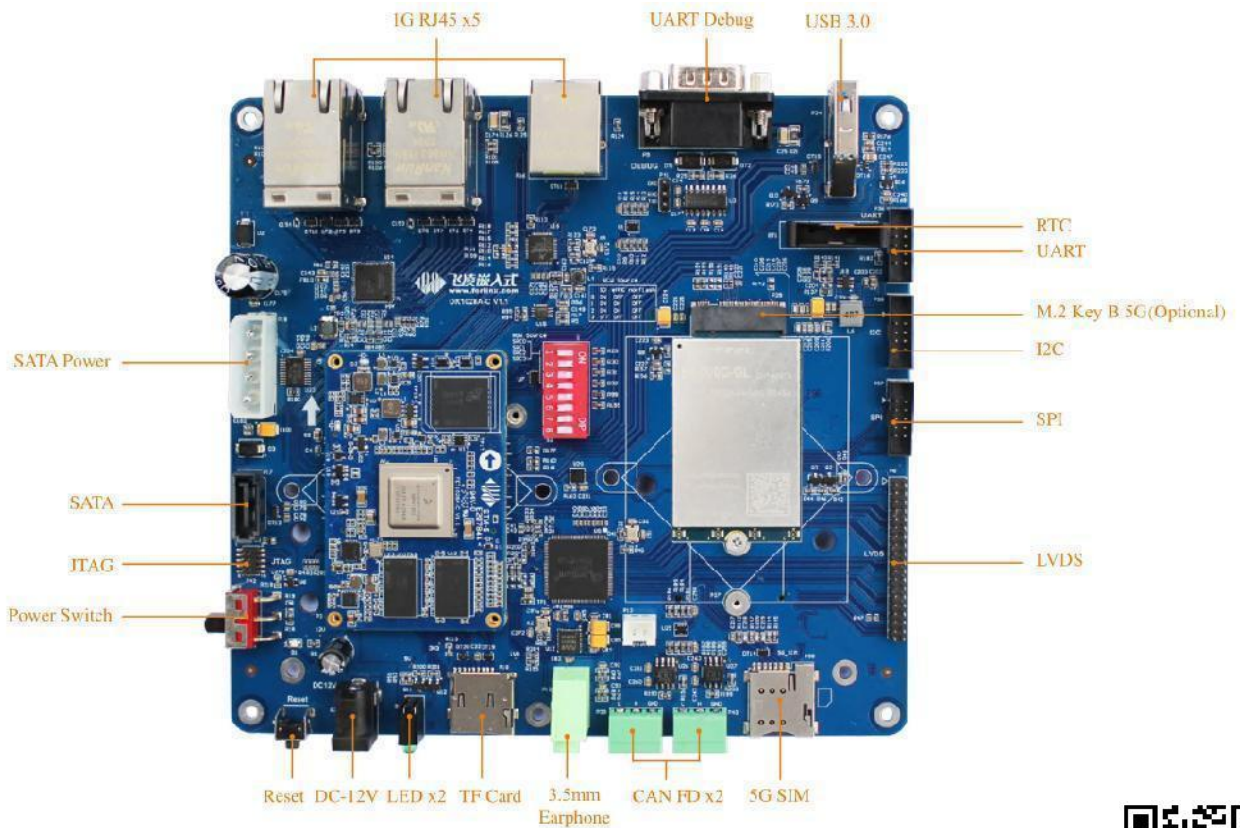



FET1046A-C SoM

OVERVIEW



FET1046A-C system on module (SoM) is based on NXP Cortex-A72 featuring quad-core processor LS1046A with frequency up to 1.8GHz, the processor can support 8 native Gigabit Ethernet, up to 2 XFI(10GbE). PCIw3.0 (x4), SATA3.0, USB3.0, UART, IIC peripheral interfaces are available, in software view, Ubuntu and OpenWRT are both well supported. Target applications are industrial router, edge computing gateway, IP-PBX, energy management, automation, etc.

SoM FET1046A-C Features

CPU	NXP LS1046A	Dimensions	84x 55mm
Architecture	Cortex-A72	Ethernet	≤8, CPU has 8 native MAC, 8x 1Gbps Ethernet 1x 10Gbps and 7x 1Gbps Ethernet 2x 10Gbps and 5x 1Gbps Ethernet
Frequency	1.8GHz	PCIe3.0	≤3, SerDes configurable, supports x1, x2 and x4, each up to 8GT/s
RAM	2GB/4GB DDR4	SATA3.0	≤1, up to 6Gbps, SerDes configurable
Flash	8GB eMMC,16MB QSPI NorFlash	USB3.0	≤3, up to 5Gbps
OS	Ubuntu-18.04.1/OpenWrt v18.06.0-rc2	UART	≤4, contains one debug port
Voltage input	DC12V	IIC	≤2
Working Temp	-40°C~ +75°C	eSDHC	≤1, supports SD3.0 eMMC4.5, multiplexed with eMMC, can be used for card booting or OS installation, but could not used for storage expanding
Package	COM Express (220pin, 0.5mm)	JTAG	supports CodeWarrior TAP from NXP
SerDes	8-lane SerDes: one SATA3.0 controller; 3x SGMII up to 2500Mbit/s; 1x QSGMII;	5x SGMII up to 100Mbit/s; 2x XFI(10GbE); 3x PCIe3.0 controller	

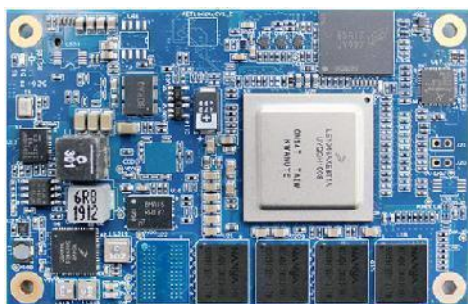

OK1046A-C2 Carrier Board Features

SFP+	2, up to 10Gbps, can support SFP+ optical module and electrical module
1Gbps Ethernet	5, 10M/ 100M/ 1000M, 3 from SGMII and 2 from RGMII
mSATA	1, SATA3.0, up to 6Gbps
M.2 E key	1, contains PCIe x1, can be mounted with WiFi module
M.2 B key	1, contains PCIe x1, USB3.0 and SIM, for 5G wireless module
USB3.0	1, up to 5Gbps
UART	3, TTL, 3-wire serial
RTC	1, CR2032
User key	1, for user's definition

TARGET APPLICATION

Industrial IoT, TSN, SD-WAN, 5G CPE, edge computing, gateway, IP-PBX, smart factory, information security, intelligent transport, power management, etc.

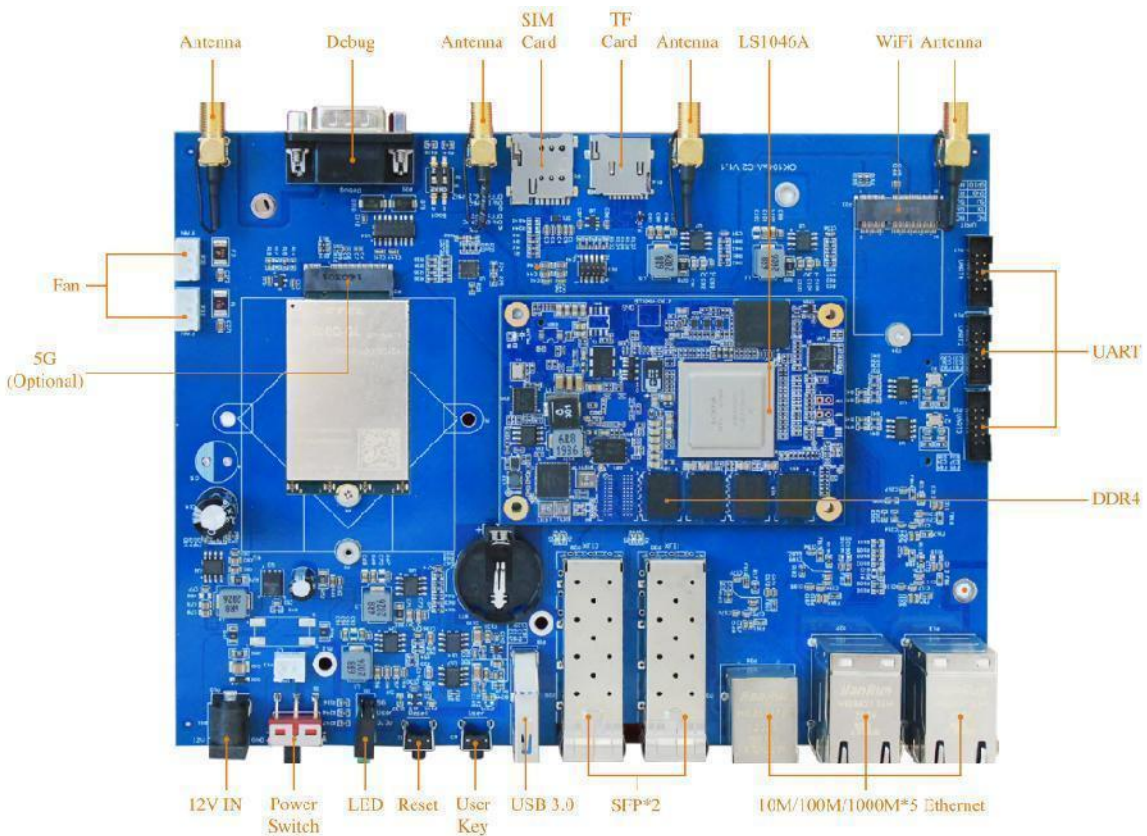



FET1043A-C SoM

OVERVIEW



FET1043A-C system on module(SoM) is based NXP Cortex -A53 featuring quad-core processor LS1043A with frequency up to 1.6GHz has 7 native Ethernet interface(1x 10Gbps and 6x 1000Mbps), it has PCIe2.0, SATA3.0, USB3.0, UART, IIC and other peripherals ready-to-use and supports both Ubuntu and OpenWRT. It is applicable for router, IoT gateway, IP-PBX and other similar products, and fields such as edge computing, energy related gateway, smart city, industrial automation, video surveillance, etc.

SoM FET1043A-C Features

CPU	NXP LS1043A	Dimensions	84x 55mm
Architecture	Cortex-A53	Ethernet	≤7, CPU has 7 native MAC, up to 1x 10Gbps and 6x 1Gbps Ethernet
Frequency	1.6GHz	PCIe2.0	≤3, SerDes configurable, 5Gbps
RAM	2GB DDR4	SATA3.0	≤1, up to 6Gbps, SerDes configurable
Flash	8GB eMMC, 16MB QSPI NorFlash	USB3.0	≤3, up to 5Gbps
OS	Ubuntu-18.04.1/OpenWrt v18.06.0-rc2	UART	≤4, contains one debug port
Voltage input	DC12V	IIC	≤2
Working Temp	-40°C~ +80°C	eSDHC	≤1, supports SD3.0 eMMC4.5, multiplexed with eMMC, can be used for card booting or OS installation, but could not used for storage expanding
Package	COM Express (220pin, 0.5mm)	JTAG	supports CodeWarrior TAP from NXP
SerDes	4 SerDes lanes; 3x PCIe2.0 controller; 4x SGMII up to 1000Mbit/s; 1x SFI(10GbE);	1x SATA3.0 controller; 2x SGMII up to 2500Mbit/s; 1x QSGMII	

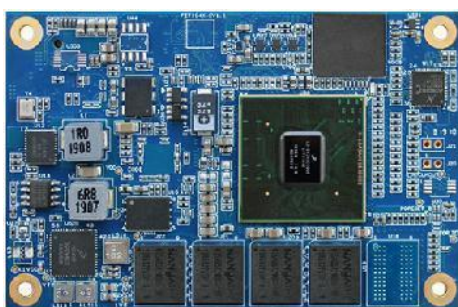

OK1043A-C3 Carrier Board Features

SFP+	up to 10Gbps, can support SFP+ optical module and electrical module
1Gbps Ethernet	6, 10M/ 100M/ 1000M, 4 from QSGMII and 2 from RGMII
M.2 M key	1, contains PCIe2.0 x1, for static hard disk
M.2 E key	1, contains PCIe x1, can be mounted with WiFi module
M.2 B key	1, contains USB3.0 and SIM, for 5G wireless module
USB3.0	1, up to 5Gbps
UART	TTL, 3-wire serial
Debug	1, RS232
4G	Mini PCIe socket, perserved with USB signal and SIM card slot, only for 4G wireless module
TF card	Multiplexed with eMMC, can be used for uboot guiding, but could not for storage expanding

TARGET APPLICATION

Industrial IoT, TSN, SD-WAN, 5G CPE, edge computing, gateway, IP-PBX, smart factory, information security, intelligent transport, power management, etc.

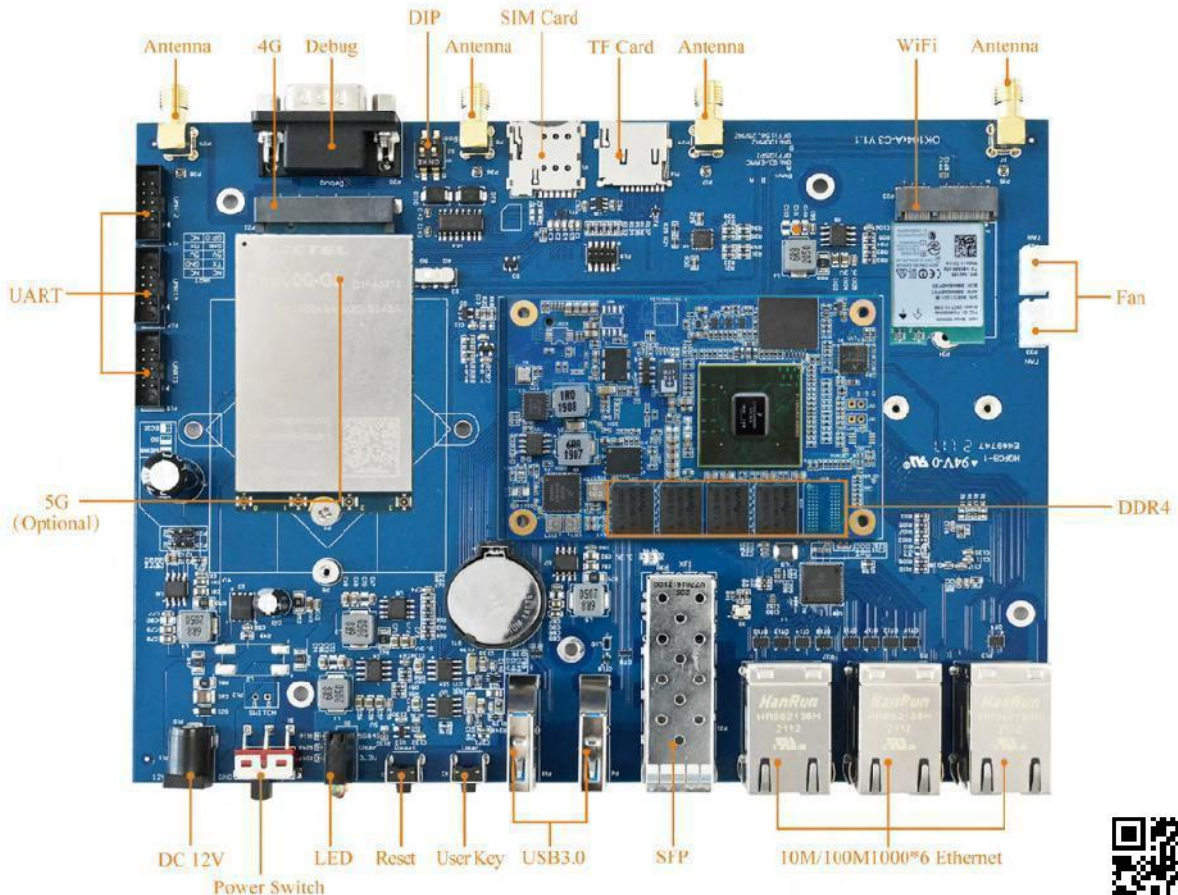



FET1012A-C SoM

OVERVIEW



FET1012A-C system on module(SoM) is designed based on NXP Cortex -A53 featuring processor LS1012A @ 800MHz. It consists of carrier board and SoM and integrates with multiple high-speed peripherals include dual gigabit Ethernet PHYs with hardware packet acceleration engine, SATA3.0, PCIe2.0, USB3.0, TF card and other interfaces. It's specially supported with Ubuntu and OpenWRT and aiming at NAS, IoT gateway, broadband Ethernet gateway and industrial automation markets.

SoM FET1012A-C Features

CPU	NXP LS1012A	Ethernet	≤2, 10/ 100/ 1000Mbps
Architecture	Cortex-A53	PCIe2.0	≤1, up to 5Gbps, can be used for Gigabit Ethernet or dual-band WiFi expanding
Frequency	1.0GHz	SATA3.0	≤1, up to 6Gbps
RAM	512MB DDR3L	USB3.0	1, up to 5Gbps
Flash	8GB eMMC,16MB QSPI NorFlash	QSPI	1, for nor flash
OS	Ubuntu-18.04.1/OpenWrt v18.06.0-rc2	SAI	≤5
Voltage input	DC4.2V	UART	≤2, contains one debug port
Working Temp	-40°C~ +80°C	IIC	≤1
Package	board to board connector	JTAG	supports CodeWarrior TAP from NXP
Dimensions	45x 40mm	SDHC	1, for storage expanding



OK1012A-C Carrier Board Features

Ethernet	2, 10M/ 100M/ 1000Mbps
PCIe2.0	≤1, up to 5Gbps, can expand Gigabit Ethernet by RTL8211 or expand dual-band WiFi by WLE900VX
SATA3.0	≤1, up to 6Gbps
USB3.0	1, up to 5Gbps
QSPI	1, for NOR Flash
UART	≤2
RTC	supported
TF card	1, for storage expanding
JTAG	1, recommended models: NXP CodeWarrior TAP

TARGET APPLICATION

Industrial router, NAS, industrial automation, edge computing, smart city, IoT gateway, etc.

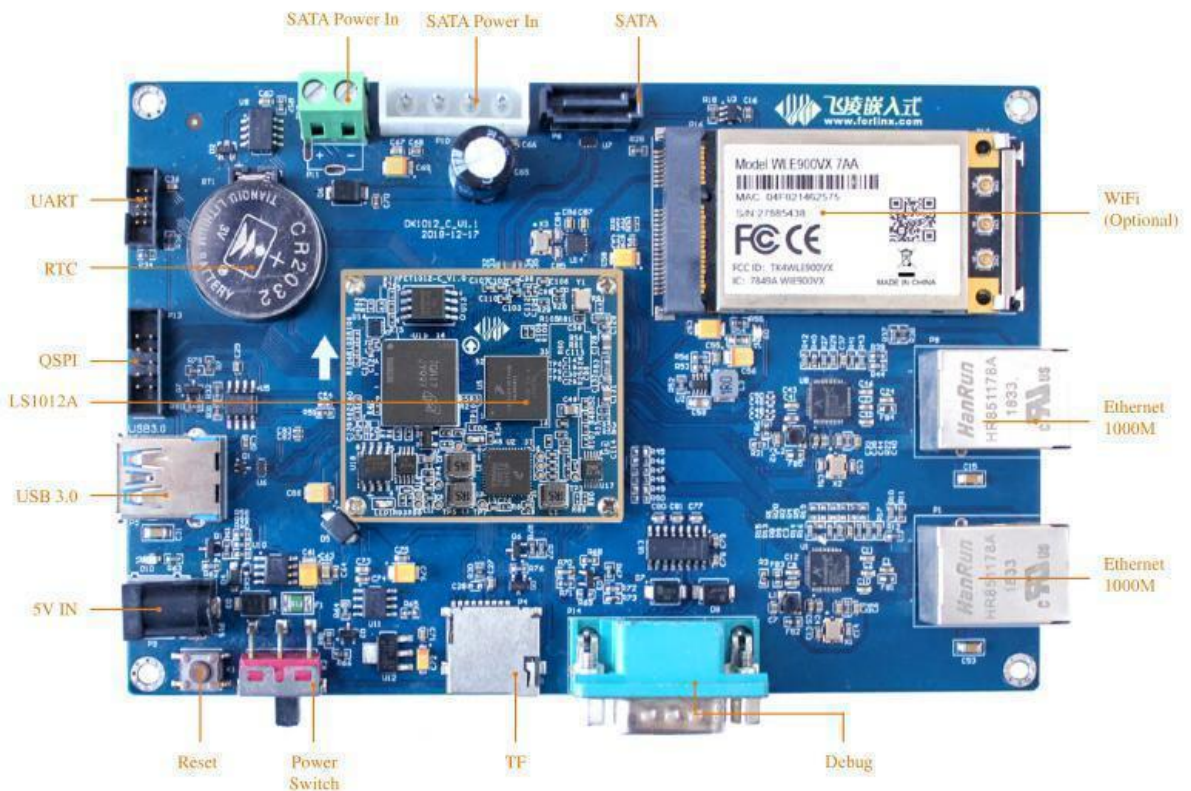

OVERVIEW



FETA40i-C system on module is based on Allwinner Cortex -A7 quad-core industrial grade processor A40i with frequency up to 1.2GHz, it integrates with GPU MALI400MP2, RAM 1GB/ 2GB DDR3L and 8GB eMMC. Mostly popular video and image encode forms are perfectly supported. It is a superior item with advantages of excellent performance in industrial grade stability but low power and cost efficient performance.

SoM FETA40i-C Features

CPU	Allwinner A40i	UART	8
Architecture	Cortex-A7	IIC	5
Frequency	1.2GHz	SPI	4
RAM	1GB DDR3(2GB optional)	Camera	2x DVP, 4x TVIN
Flash	8GB eMMC	SD/MMC/SDIO	4
OS	Linux3.10+QT5.9, Android7.1	USB	2x USB2.0 Host, 1x USB2.0 OTG
Voltage input	DC5V	SATA	1
Working Temp	-20°C~ +85°C / -40°C~ +85°C	PWM	8
Package	4x 80-pin connector, 0.5mm	Audio codec	1
Dimensions	45x 68mm	JTAG	1
PMIC	AXP221S	Keypad	1
GPU	Mali400MP2	key ADC	2
Video codec	hardware codec	SMC	2
Display	2x RGB888, 2x 8-bit LVDS, 1x HDMI 1x MIPI-DSI, 4x TVOUT	PS2	2
IIS/ PCM	2	CIR	2
Ethernet	1x 10/100Mbps ; 1x 10/ 100/ 1000Mbps	AC97	1



OKA40i-C Carrier Board Features

Display	1x RGB888, 1x 8-bit LVDS, 1x HDMI 1x MIPI-DSI, 1x TVOUT	SATA	1
Audio	1x MIC, 1x Phone, 1x Speaker	WiFi& BT	1
Ethernet	1x 10/100Mbps, 1x 10/100/ 1000Mbps	JTAG	1
UART	4(2x 5-wire, 2x 3-wire)	RS485	1, isolated
RS232	1, debug port	4G	1
IIC	4	LED	2
SPI	2	PWM	1
Camera	1x DVP, 4x TVIN	RTP	4
SD/MMC/SDIO	2x SD card, 1x SDIO	SMART_CARD	1
USB Host	3, USB2.0	Key	3
USB OTG	1, USB2.0	RTC	1

TARGET APPLICATION

Advertising machine, digital signage, self-service terminal, O2O smart device, robotic, medical, car electronics, etc.

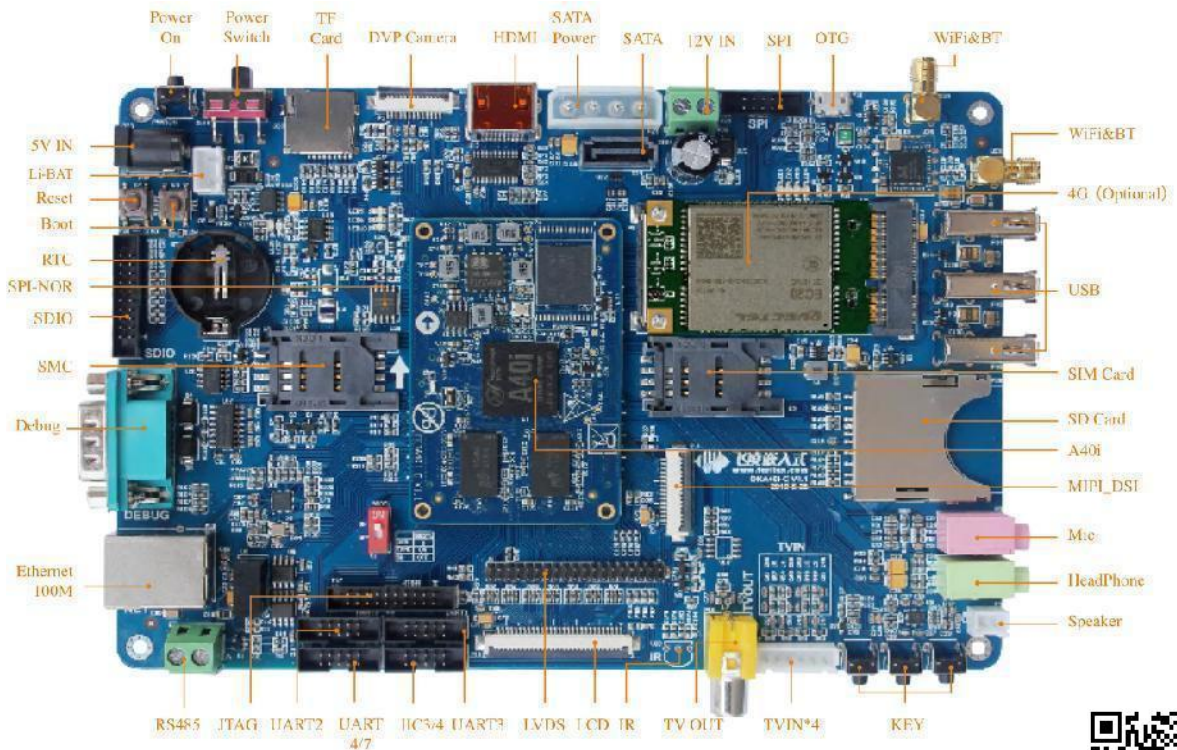

OVERVIEW



FETT3-C system on module (SoM) is based on Allwinner Cortex-A7 quad-core in car entertainment navigation system processor T3 @ 1.2GHz, it has built-in GPU Mali400MP2, and has on-board 1GB DDR3L and 8GB eMMC. The whole board is designed with industrial grade temp width, can it can support most video and image decoding forms. Supported with OS Android and Linux, excellent industrial grade product performance

SoM FETT3-C Features

CPU	Allwinner T3	UART	8
Architecture	Cortex-A7	IIC	5
Frequency	1.2GHz	SPI	4
RAM	1GB DDR3(2GB optional)	Camera	2x DVP, 4x TVIN
Flash	8GB eMMC	SD/MMC/SDIO	4
OS	Linux3.10+QT5.9, Android7.1	USB	2x USB2.0 Host, 1x USB2.0 OTG
Voltage input	DC5V	SATA	1
Working Temp	-20°C~ +85°C / -40°C~ +85°C	PWM	8
Package	4x 80-pin connector, 0.5mm	Audio codec	1
Dimensions	45x 68mm	JTAG	1
PMIC	AXP221S	Keypad	1
GPU	Mali400MP2	key ADC	2
Video codec	hardware codec	SMC	2
Display	2x RGB888, 2x 8-bit LVDS, 1x HDMI 1x MIPI-DSI, 4x TVOUT	PS2	2
IIS/ PCM	2	CIR	2
Ethernet	1x 10/100Mbps ; 1x 10/ 100/ 1000Mbps	AC97	1



OKT3-C Carrier Board Features

Display	1x RGB888, 1x 8-bit LVDS, 1x HDMI 1x MIPI-DSI, 1x TVOUT	SATA	1
Audio	1x MIC, 1x Phone, 1x Speaker	WiFi& BT	1
Ethernet	1x 10/100Mbps, 1x 10/100/ 1000Mbps	JTAG	1
UART	4(2x 5-wire, 2x 3-wire)	RS485	1, isolated
RS232	1, debug port	4G	1
IIC	4	LED	2
SPI	2	PWM	1
Camera	1x DVP, 4x TVIN	RTP	4
SD/MMC/SDIO	2x SD card, 1x SDIO	SMART_CARD	1
USB Host	3, USB2.0	Key	3
USB OTG	1, USB2.0	RTC	1

TARGET APPLICATION

Navigation, smart device, industrial control, machine vision, IoT, digital signage, medical, etc.

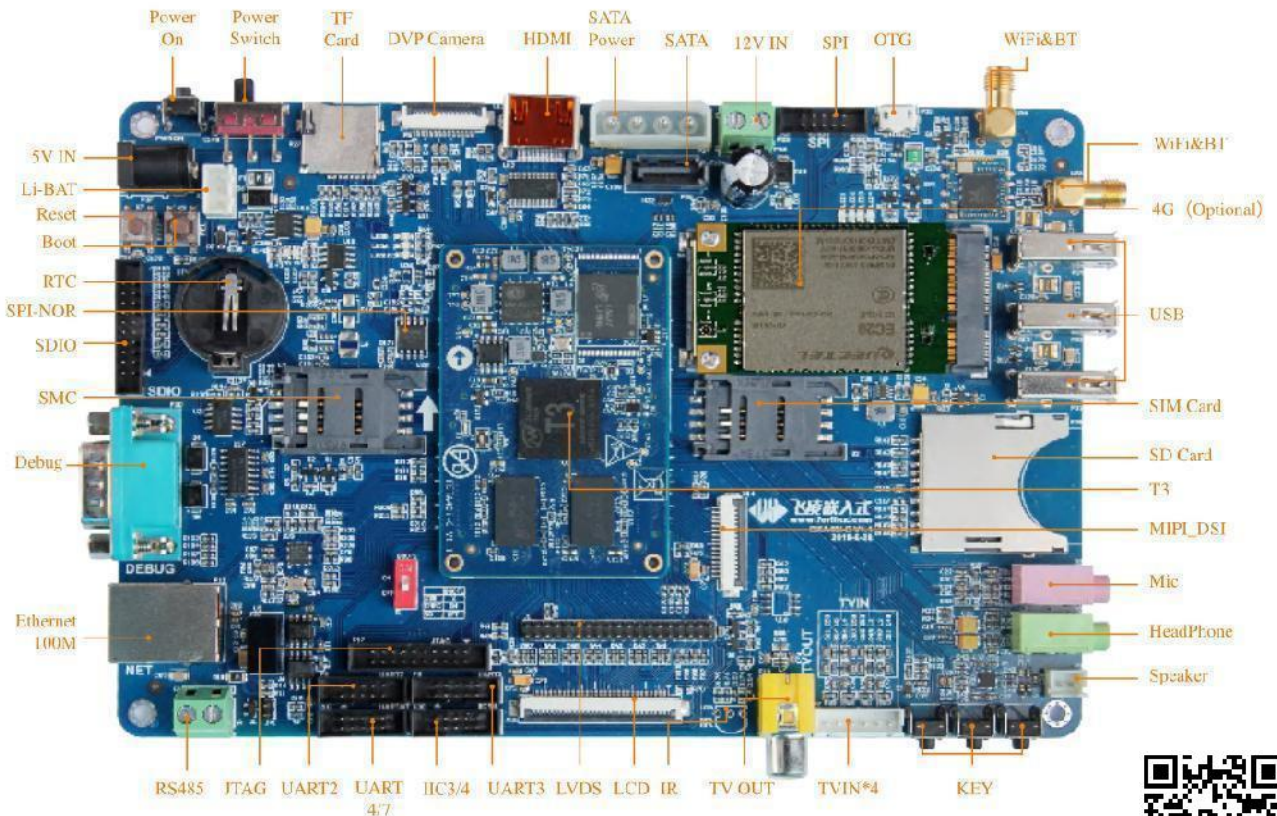

OVERVIEW



FETT507-C system on module is based on Allwinner quad-core automotive grade SoC T507 belongs to Cortex-A53 architecture runs at speed up to 1.5GHz, and it integrates with G31 GPU, carries 2GB DDR3L and 8GB eMMC on-board. It supports most mainstream video and image codec forms. It has advantages of industrial grade, low power performance and plenty peripherals, can support Linux, Android and Ubuntu TBD very well, applicable for car electronics, power industry , medical, industrial control , IoT and all kinds of smart devices..

SoM FETT507-C Features

CPU	Allwinner T507	UART	6, up to 4Mbit/s
Architecture	Cortex-A53	IIC	5
Frequency	1.5GHz	SPI	1
RAM	2GB DDR3L	SD/MMC/SDIO	2
Flash	8GB eMMC	USB	4x USB2.0, 1x OTG, 3x Host
OS	Linux4.9+QT5.12, Ubuntu18.04, Android 10	PWM	6
Voltage input	DC5V	Audio codec	1
Working Temp	-40°C~ +85°C	GPADC	4
Package	3x 80-pin connector, 0.5mm	SCR	1, ISO/IEC 7816-3
Dimensions	40x 70mm	CIR	1
GPU	G31 MP2, supports OpenGL ES 3.2/2.0/1.0, Vulkan 1.1, OpenCL 2.0	IIS/ PCM	4, 3 for peripheral, 1for HDMI
Display	CVBS output, supports NTSC and PAL, HDMI2.0a, 4K@60FPS RGB/ LVDS, up to 1920x1080@60fps	Ethernet	2, 1x 10/100Mbps RMII, 1x 10/100/1000Mbps RGMII
Video codec	Hardware decode: H.265, VP9, VP8, AVS2, up to 4K@60fps; H.264 up to 4K@30fps; Hardware encode: H.264, up to 4K@25fps; MJPEG, up to 4K@15fps		
Camera	1x 4-lane MIPI-CSI, capturing rate up to 8M@30FPS or 4x 1080P@25FPS; 1x DVP, up to 5M@ 15FPS or 1080P@30FPS		



OKT507-C Carrier Board Features

Display	1x RGB888, 1x HDMI, 1x TVOUT 1x dual 8-bit LVDS LVDS is multiplexed with RGB	Key	6, VOL+, VOL-, MENU, ENTER, HOME, PWRON
Audio	1x Line OUT, 1x MIC, 1x Phone, 2x Speaker	4G	Mini PCIe socket
Ethernet	1x 10/100Mbps, 1x 10/100/ 1000Mbps	RTC	1
UART	TTL, 10-pin header	ADC	4, 1.8V
Camera	1x 4-lane MIPI-CSI, 1x 8-bit DVP	PWM	1, for display backlight
USB Host	2, USB2.0 Type-A femal connector	SD/MMC/SDIO	compatible with SD3.0
USB OTG	1x Micro USB, host/ slave optional, for OS installation	WiFi& BT	Model: AP6256 WLAN: IEEE 802.11b/g/n BT: BT5.0

TARGET APPLICATION

Navigation, smart device, industrial control, machine vision, IoT, digital signage, medical, etc.

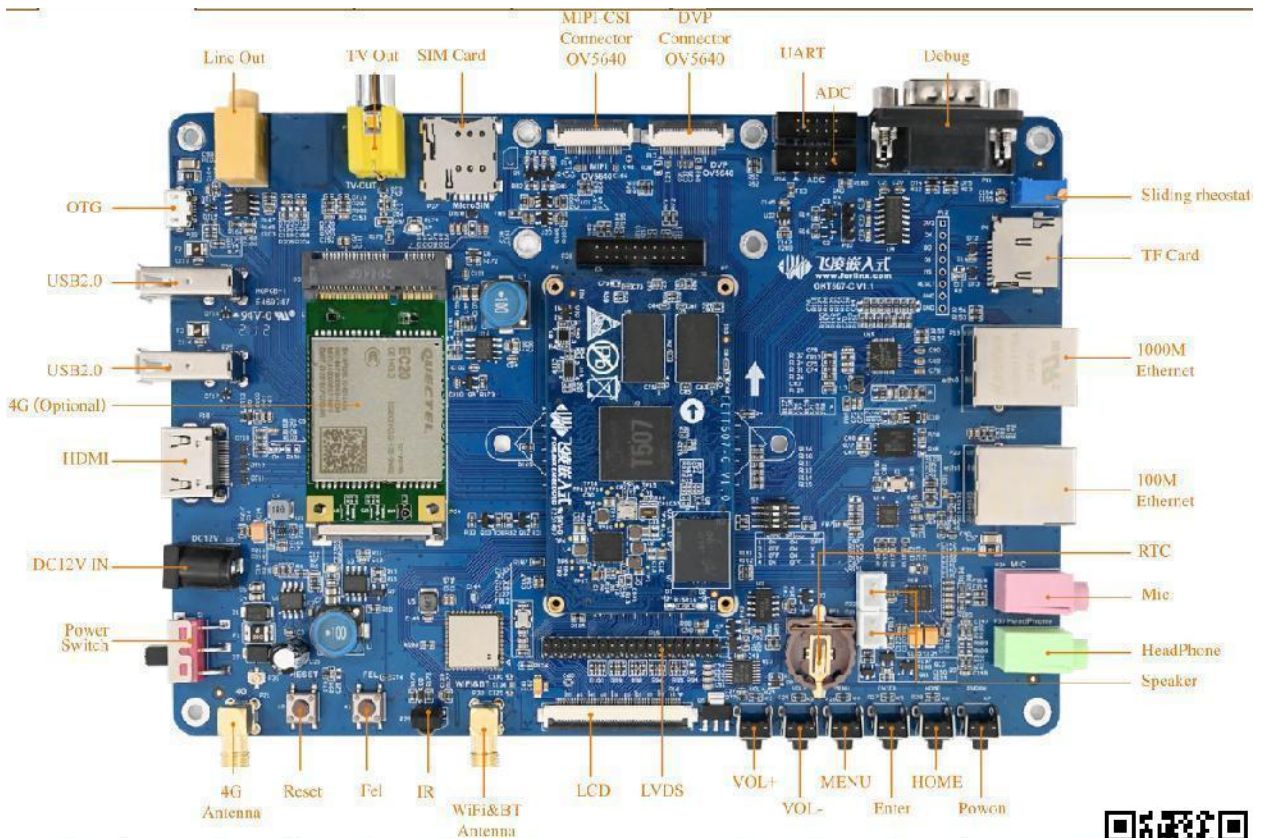



FET3588-C SoM

OVERVIEW



FET3588-C System on Module (SoM) carries Rockchip's advanced hybrid processor RK3588 contains quad-core Cortex-A76 and Cortex-A55 cores, A76 core runs up to 2.4GHz, and A55 core clock up to 1.8GHz. It has a super advanced engine can support up to 8K output, quad-screen with different content output; The SoM has been subjected to rigorous ambient temperature testing that approve it a trusted and best option for high-end applications.

SoM FET3588-C Features

CPU	Rockchip RK3588	Audio	I2S ≤4
Architecture	4x Cortex-A76@2.4GHz 4x Cortex-A55@1.8GHz		2x SPDIF
RAM	4GB / 8GB LPDDR4		2x PDM
Flash	32GB / 64GB eMMC		1x DSM PWM
OS	Android12	Ethernet	2x GMAC by RGMII / RMII
Voltage input	DC12V	USB3.1 Gen1	3
Working Temp	0°C~ +80°C	USB 2.0 Host	2
Package	4x 100-pin connector, 0.4mm	PCIe 2.0	3
Dimensions	68x 50mm	PCIe 3.0	2
Video input	2x MIPI DC PHY(DPHY/CPHY)	Video output	2x HDMI/eDP TX
	4x MIPI CSI DPHY		2x DP TX
	1x DVP		2x MIPI DSI
	1x HDMI RX		1x BT.1120
SPI	5	I2C	9
UART	10	CAN	3
SATA	3	PWM	16, Up to 16 on-chip PWM
ADC	8x 12-bit single-end input SAR-ADC, sampling rate up to 1MS/s		

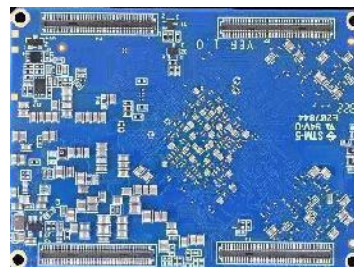
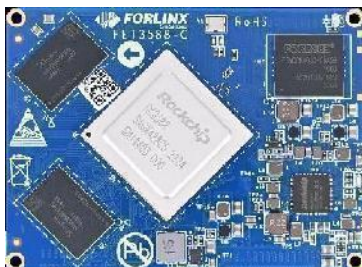

OK3588-C Carrier Board Features

MIPI CSI	5, 4K@60Hz, 2x MIPI DPHY V2.0 4 lanes, 2x MIPI DPHY V1.2 2 lanes, 1 x MIPI DPHY V1.2 4 lanes	eDP TX	1, Can fit 1080p@60Hz display; Up to 4K@60Hz
MIPI-DSI	2x 4-lane output, up to 4K@60fps;	DP TX	2 DP used together with USB3.1 Gen1 by type-c connector, up to 680x4320@30Hz
HDMI RX	1, Standard HDMI connector, up to 4K@60Hz	USB3.1 Gen1	2, Type-C connector, used together with DP TX, up to 5Gbps
HDMI	1, Standard HDMI connector, up to 7680x4320@60Hz	USB2.0 Host	1, available on carrier board by Type-A USB connector;
PCIe3.0	1x4 lanes PCIe signal is available on carrier board by PCIe x 4 slot	PCIe2.0	1, by PCIe x 1 slot, up to 5Gbps
Ethernet	2, RJ 45 connector, 10/100/1000 Mbps	TF card slot	1, Up to 150MHz, supports SDR104 mode
Audio	1, supports earphone output, MIC input and Speaker	CAN	2, CAN2.0B
RS485	1	UART	1, headers with 2.54mm pitch, up to 4Mbps
4G/ 5G	1, M.2 4G/ 5G module	WiFi& BT	1, M.2, supports WI-FI 6 SU and MU-MIMO + Bluetooth 5.3
ADC	5, PH2.0 connector, up to 12-bit resolution and 1MS/ s sampling rate	RTC	1
Fan	1	GPIO	Pin headers with pitch of 2.54mm(3.3V) for 9 GPIO and power of 5V/ 3.3V/ 1.8V

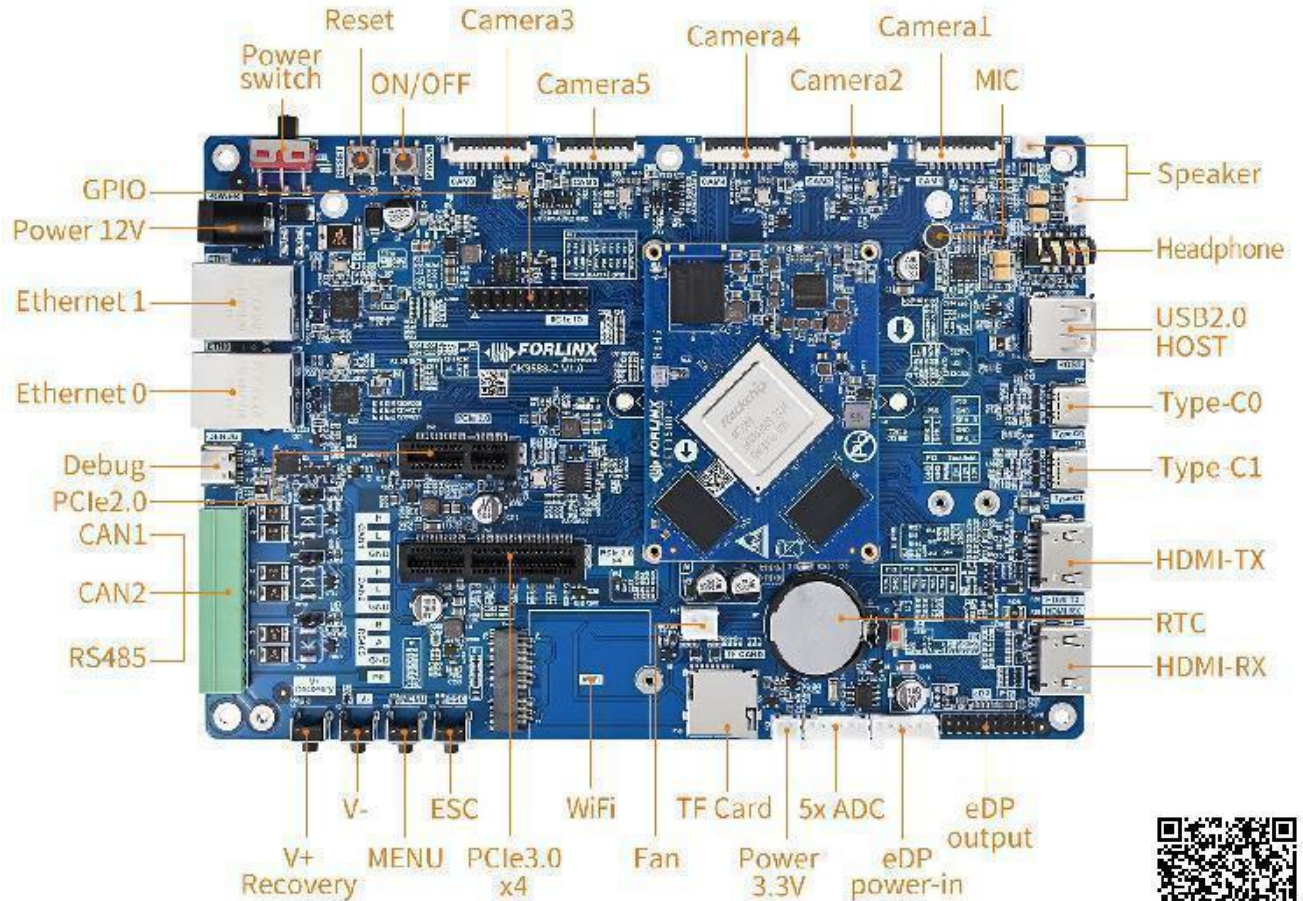



FET3399-C SoM

OVERVIEW



FET3399-C system on module comes from Rockchip RK3399 processor consists of two Cortex-A72 cores up to 1.8GHz and four Cortex-A53 cores up to 1.4GHz. It's integrated with GPU Mali-T864, can support OpenGL ES1.1/ 2.0/ 3.0/ 3.1, OpenVG1.1, OpenCL and DX11. It has on-board 2GB LPDDR3 RAM and 16GB eMMC. A variety of display interfaces such as HDMI2.0, MIPI-DSI, eDP1.3 and DP1.2 are all available up to 4K. Dual-screen both synchronous and asynchronous playing are supported. Besides, it carries PCIe, USB3.0 Host, Type-C, MIPI-CSI, SPDIF, IIC, SPI, UART, ADC, PWM, GPIO, IIS and Ethernet on board.

SoM FET3399-C Features

CPU	Rockchip RK3399	IIS/ PCM	3
Architecture	2x Cortex-A72@1.8GHz 4x Cortex-A53@1.4GHz	SD/ MMC	2 , SD/MMC/SDIO3.0
RAM	2GB / 4GB LPDDR3	PCIe	1, PCIe2.0 x4
Flash	16GB / 32GB eMMC	USB2.0	2, USB Host2.0
OS	Linux4.4+QT5.12, Android 7.1 ForlinuxDesktop 18.04	USB Type-C	2, USB 3.0/2.0, DP1.3
Voltage input	DC12V	Ethernet	1, RGMII/ MII
Working Temp	0°C~ +80°C	SPI	5
Package	4x 80-pin connector, 0.5mm	UART	5
Dimensions	46x 70mm	IIC	7
GPU	Mali-T860MP4	PWM	3, 32-bit
Camera	2x MIPI-CSI, one 13.0MP camera or two 8.0MP cameras	ADC	5, 10-bit
Video codec	Decode: • H.265/HEVC up to 4Kx2K @ 60fps; • VP9 up to 4Kx2K @ 60fps • H.264/AVC up to 4Kx2K @ 30fps Encode: • 1080p30 AVC/H.264 • 1080p30 VP8	Display	dual display engines up to 4096x2160 and 2560x1600 by below interface: • 2x MIPI-DSI, up to 2560x1600@60fps; • 1x eDP1.3, supports 4 data lanes; • 1x DP1.2, up to 4Kx2K@60Hz; • 1x HDMI2.0, up to 4Kx2K@60Hz

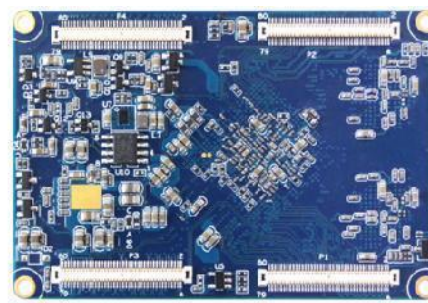

OK3399-C Carrier Board Features

HDMI	1, 4K@60Hz	TF card	1
MIPI-DSI	1x 4-lane	Ethernet	1x 10/100/1000Mbps, RJ45 connector
eDP	1x 4-wire, 10.8Gbps	Camera	2x MIPI-CSI, one 13.0MP or two 8.0MP
USB Type-C	1, USB3.0 and DP1.2	Audio	MIC, Headphone/Speaker
USB3.0	1	WiFi	IEEE 802.11a/b/g/n/ac
USB 2.0	4	BT	BT5.0
SPI	2	M.2	PCIe x4
UART	1(multiplexed with SPI1)	4G	Mini PCIe socket
IIC	1	GPIO	4
ADC	2	Debug	USB converted to serial

TARGET APPLICATION

Edge computing, facial recognition, 5G smart terminal, 3D printer, TV-box, NAS, VoIP, surveillance, IoT, etc.

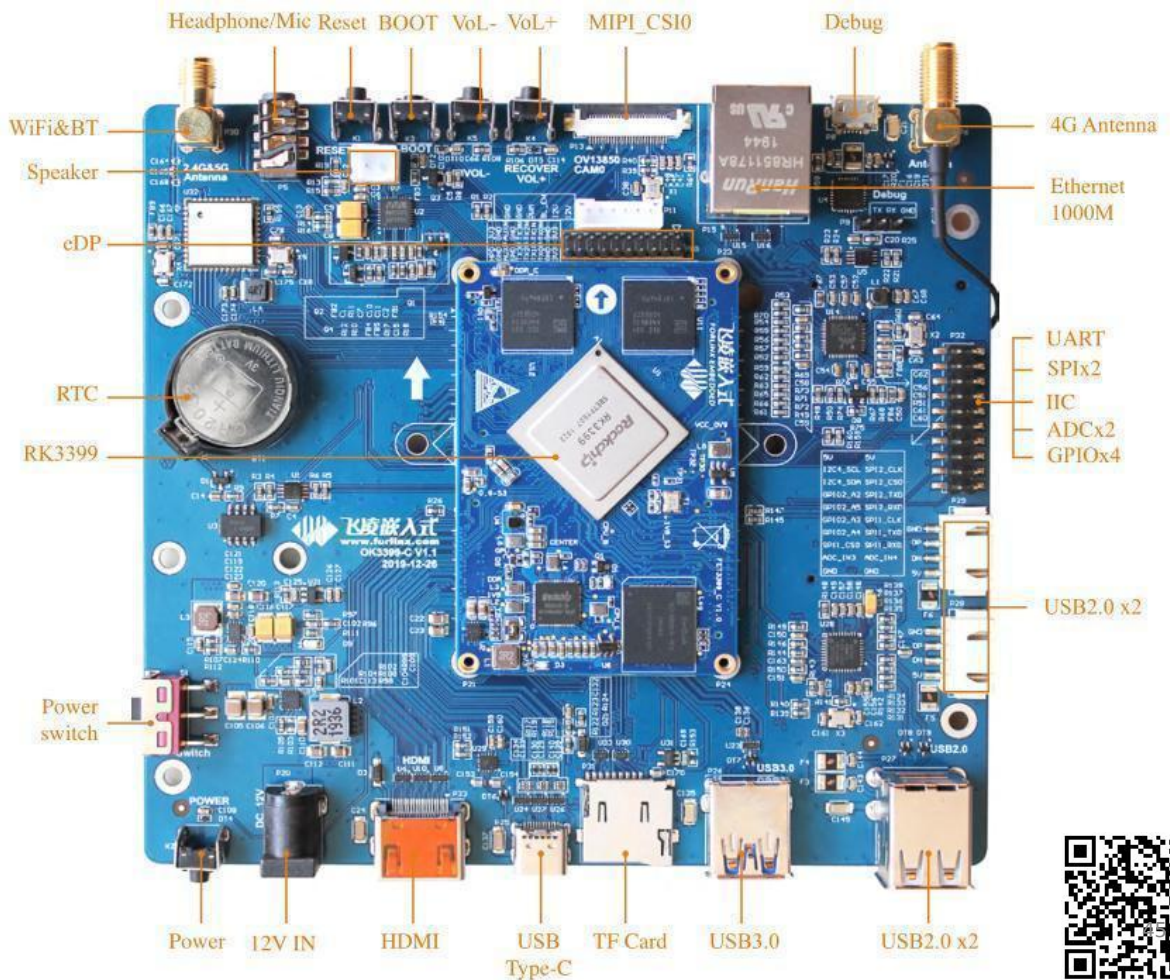



FET3568-C SoM

OVERVIEW



FET3568-C system on module (SoM) carries Rockchip's new generation AIoT processor RK3568 a 64-bit quad-core Cortex-A55 SoC equipped with NPU on board running speed at up to 2.0GHz but low power performance. The SoM approved to robust and reliable by harsh ambient temperature testing, stress testing and long-last running testing.

SoM FET3568-C Features

CPU	Rockchip RK3568	Display	3 display controllers, supports sync output of any 3 display combination of RGB, LVDS, MIPI DSI, HDMI, eDP interface.
Architecture	4x Cortex-A55@2.0GHz	Camera	2, 1x DVP, 1x 4-lane MIPI-CSI
RAM	2GB DDR4	Audio	4, 1X 8ch I2S/TDM, 2X2ch I2S, 1x8ch PDM
Flash	16GB eMMC	SDIO	2, SDIO3.0 up to 104MB/s
OS	Linux4.19+QT5.12, Android 11	Ethernet	2x GMAC, from RMI/ RGMII
Voltage input	DC5V	USB2.0	2, USB2.0 Host, separate but not multiplexed
Working Temp	commercial grade 0°C~ +70°C industrial grade -40°C~ +85°C	USB2.0	2, 1 USB2.0 host, 1x USB2.0OTG contained in USB3.0
Package	4x 80-pin connector, pitch 0.5mm	USB3.0	2, 1x USB3.0 Host, 1x USB3.0 OTG
Dimensions	45x 70mm	SATA	3, SATA3.0 up to 6.0Gb/s, supports eSATA
GPU	Mali-G52-2EE	PCIe2.1	1x PCIe2.1, up to 5.0Gbps, RC mode
VPU	Decode: H.264, H.265, VP8, VP9, VC1 MPEG-4, MPEG-2, MPEG-1, H.263 Encode: H.264/AVC, H.265/HEVC	PCIe3.0	2, 1x 2-lane or 2x 1-lane, each lane up to 8.0Gbps, 1-lane is only available for RC mode, 2-lane is available for both RC mode and EP mode
NPU	1TOPS	UART	10, up to 4Mbps
CAN	3, supports CAN-FS and CAN2.0B	SPI	4, host and slave modes are configurable
IIC	5, 7-bit and 10-bit address mode, up to 1Mbit/s	PWM	16x 32-bit timer and counter

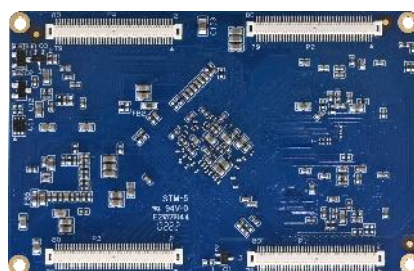

OK3568-C Carrier Board Features

Display	1x HDMI2.0, 1x eDP, 1x LVDS, 1x RGB, 1x MIPI DSI 1	PCIe2.1	PCIex1 slot, multiplexed with SATA
Camera	1x MIPI CSI OV13850	PCIe3.0	PCIex4 slot, can be congigured to 2 PCIex1
Audio	1x stereo earphone, 1x MIC 1x 1.3W D-class amplifier	UART	3x TTL by pin header with pitch of 2.54mm
Micro-SD card	for firmware installation and storage expanding	CAN	2, CAN-FD, up to 5Mbps, ESD& isolated
Ethernet	2x 10/ 100/ 1000Mbps, RJ45	SPI	2x 3.3V TTL by pin header, pitch 2.54mm
4G/ 5G	M.2 Key-B, contains USB3.0/ 2.0	IIC	1x 3.3V TTL by pin header, pitch 2.54mm
WiFi& BT	dual-band, AW-CM358SM	RTC	recommended model CR2032
USB2.0	2x USB2.0 Host, Type-A	Key	8: reset, power, OTG, Maskrom, VOL+, VOL-, HOME, ESC
USB3.0	1x USB3.0 Host, Type-A	Debug	Type-C connector, USB converted to serial
USB2.0 OTG	2	Power adapter	DC12V

TARGET APPLICATION

Medical, industrial, transportation, cloud terminal, streaming media, security, AI application, energy management , etc.

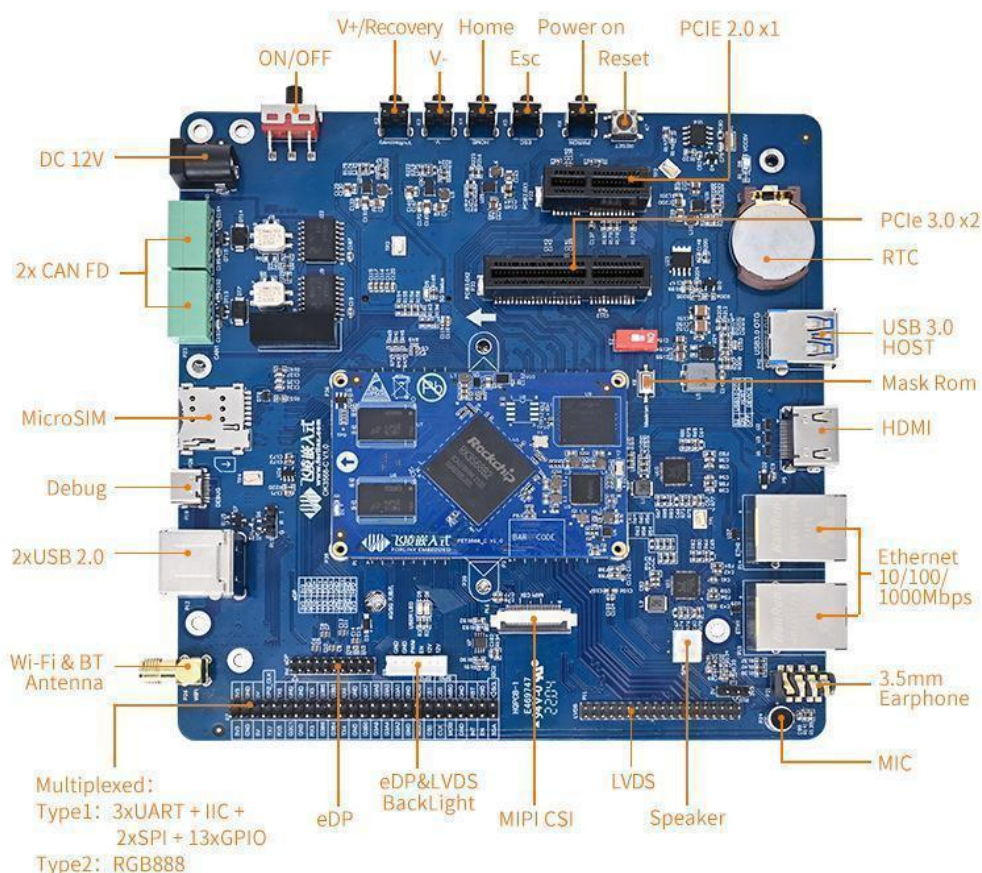

OVERVIEW

The FET6254-C is a cost efficient and advanced performance System on Module (SoM) based on TI Sitara™ AM6254 industrial grade SoCs powered by ARM Cortex A53 cores with speed up to 1.4GHz. The FET62xx-C SoM is integrated a wide array of interfaces such as 2-port Gigabit Ethernet, TSN, USB 2.0, MMC/SD, Camera interface, OSPI, CAN-FD .

SoM FET6254-C Features

CPU	TI AM6254 quad-core Cortex-A53@1.4GHz Cortex®-M4F @400 MHz GPU: AXE1-16M@500MHz OpenGL 3.x/2.0/1.1 + Extensions, Vulkan 1.2	SPI	5x MCSPI, up to 50MHz
Architecture	Cortex-A55+ M4F	IIC	6, up to 400Kbps
RAM	1GB DDR4-1600(2GB optional)	McASP	3, supports TDM, IIS, etc.
Flash	8GB eMMC	CAN-FD	3x CAN2.0 A/ B/ CAN FD, up to 5Mbps
OS	Linux5.10.87+ QT5.14.2	SD	2x 4-bit SD/ SDIO, up to UHS-I
Voltage input	DC5V	GPMC	1
Working Temp	-40°C~ +85°C	OSPI/ QSPI	1, 166MHz DDR/ 200MHz SDR
Package	board-to-board connector	PWM	3
Dimensions	60x 38mm	eQEP	3
Display	2x LVDS, up to 1920* 1080@ 60FPS or 1x RGB parallel	eCAP	3
Ethernet	2, RMI or RGMII, TSN is supported	USB	2x USB 2.0
UART	9, up to 3.6Mbps	JTAG	supported



OK6254-C Carrier Board Features

LVDS	2	IIC	MCU_I2C0 and WKUP_I2C0
RGB parallel	1, by a 16-bit (RGB565) FPC connector	GPMC	1, by 2.54mm pin headers GPMC_AD0~AD15
Camera	1x MIPI-CSI, OV5645 is recommended	Audio	1
Ethernet	2x 10/ 100/ 1000Mbps, RJ45	TF card slot	1, can support UHS-I up to 104MB/s
USB2.0	3x USB Host, 1x USB OTG	4G/ 5G	1, optional and alternative recommended 4G: EC20 recommended 5G: RM500U-CN
Debug UART	3	WiFi& BT	AW-CM358M, WiFi: IEEE 802.11 a/b/g/n/ac , BT: BT5.0, up to 3Mbps
RS485	1, isolated	Key	5, 4 keys input for A53 core, and 1 input for M4F core
CAN-FD	2, isolated	LED	8, 4 for A53 core, 4 for M4F core
SPI	1x MCU_SPI0 by pin headers	RTC	supported
EEPROM	1, 2K bit, mounted to MCU_I2C0 or WKUP_I2C0	QSPI Flash	1, 128M bit, mounted to A53 QSPI or MCU SPI0
JTAG	1, by 2x 10-pin headers, 1.27mm pitch		

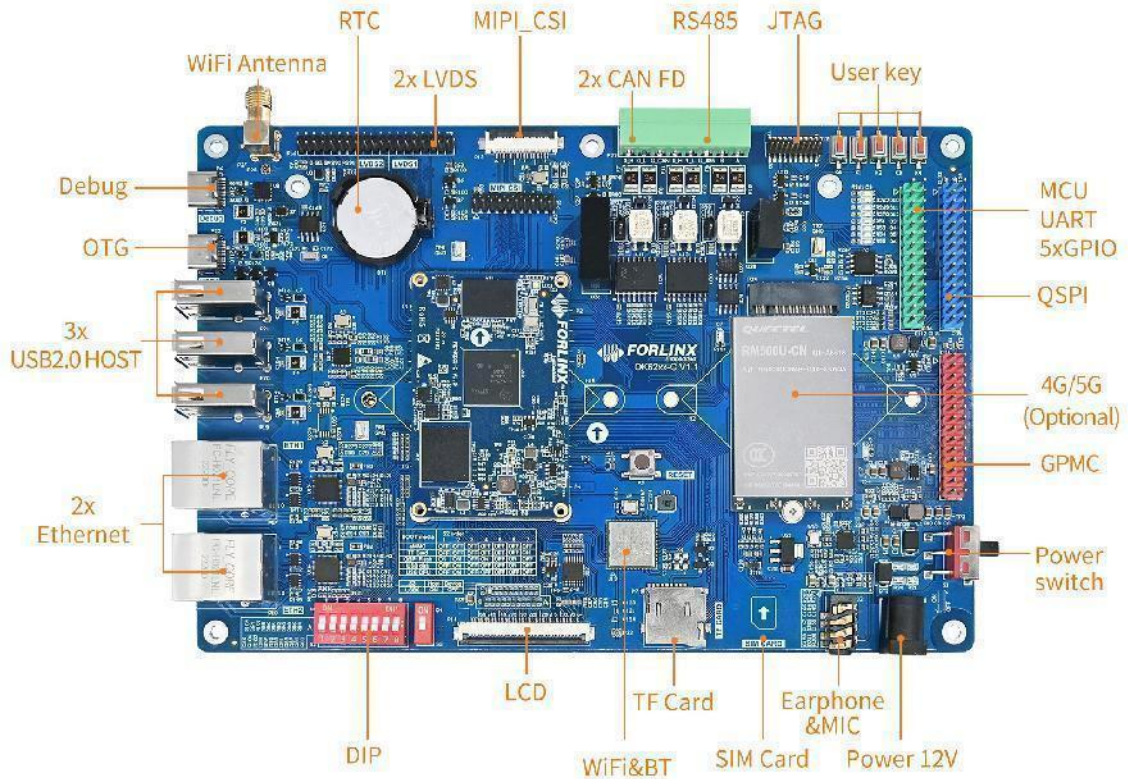

OVERVIEW



FET335xD system on module is based on AM3354 processor up to 800MHz, operating temperature ranges from -40°C to $+85^{\circ}\text{C}$. Industrial interface options such as CAN, PROFIBUS, RS485 and dual gigabit Ethernets. 324 CPU pins in total, each pin and peripheral interface pins up to 8 functional configuration. 8-layer of CPU module PCB guarantees perfect electrical and interference. SMT to be used to make sure accurate connection. OK335xD base board pins out mostly industrial used interfaces with open source code. Approved by EMC/EMI testing to make it more competitive.

SoM FET33xD Features

CPU	TI Sitara AM3354@ 800MHz	Ethernet	2x 10/ 100/ 1000Mbps
Architecture	Cortex-A8	UART	6
RAM	512MB DDR3	CAN	2
Flash	256MB NandFlash	IIC	3
OS	Android2.3/4.2, Win CE7.0/6.0, Linux3.2+QT4.8	SPI	2
Voltage input	DC5V	SD/MMC/SDIO	3
Working Temp	$-40^{\circ}\text{C} \sim +85^{\circ}\text{C}$	USB	2x USB2.0 OTG
Package	2x 100-pin header, 1.27mm	PWM	3
Dimensions	47x 71mm	JTAG	1
PMIC	TPS65217C	EINT/GPIO	supported
GPU	PowerVR SGX530	ADC	8
Display	1x RGB888	Watchdog	SP706SEN
IIS	1	GPMC	16-bit data bus, 12-bit address bus

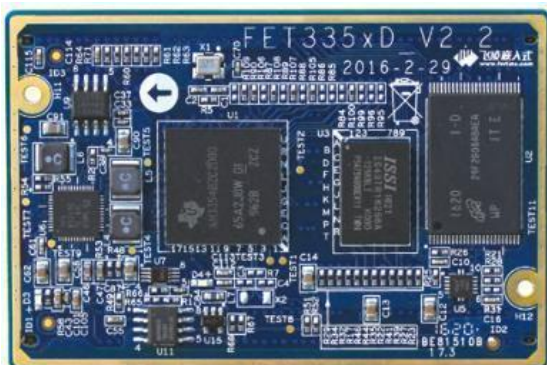

OK335xD Carrier Board Features

Display	1x RGB888	USB Host	4x USB2.0
Audio	1x Phone, 1x MIC, 1x Line in	USB OTG	1x USB2.0
Ethernet	1x 10/ 100/1000Mbps	ADC	8(4 for resistive touching, 4 for users)
UART	1, LVCOMS	PWM	1, for backlight
RS232	2(1x 3-wire, 1x debug)	RTC	supported
RS485	1, isolated	JTAG	1
CAN	1, isolated	EINT/GPIO	supported
IIC	2	Functional key	7
SPI	1	DIP	booting mode selection
FPMC	16-bit data bus, 12-bit address bus	LED	4
SD/MMC/SDIO	2(1x SD, 1x SDIO)	Power input	DC5V

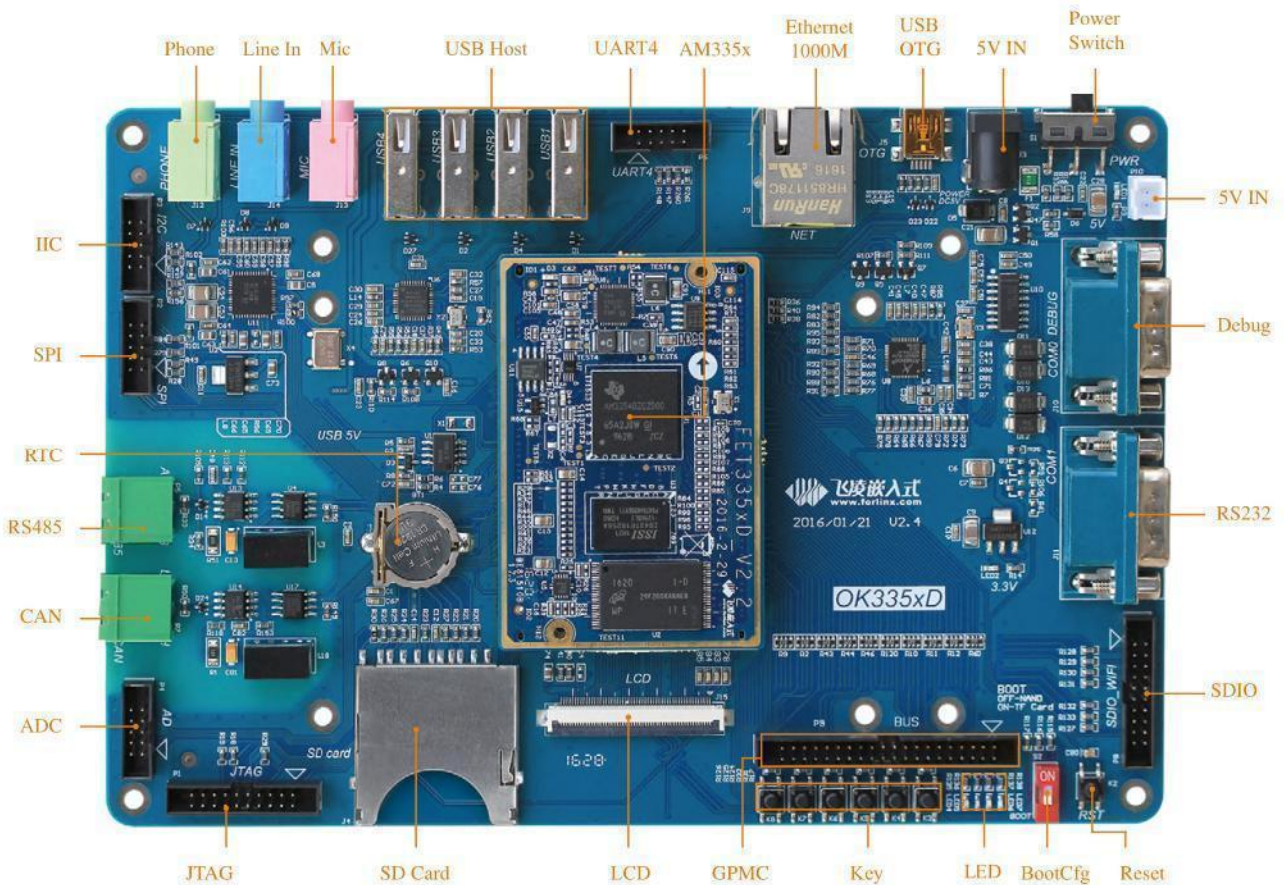

OVERVIEW



FET335xS system on module is based on AM3354 processor up to 800MHz, operating temperature ranges from -40°C to +85°C. It support many industrial bus, such as: CAN, PROFIBUS, RS485, etc, support dual gigabyte Ethernet port, 324-pin CPU module, each pin is multiplexed with up to 8 configured functions. FET335xS CPU modules have 512M DDR3 RAM and 256M Nandflash on it, could greatly help users to reduce the cost of product development.

SoM FET33xS Features

CPU	TI Sitara AM3354@ 800MHz	Ethernet	2x 10/ 100/ 1000Mbps
Architecture	Cortex-A8	UART	6
RAM	512MB DDR3	CAN	2
Flash	256MB NandFlash	IIC	3
OS	Android2.3/4.2, Win CE7.0/6.0, Linux3.2+QT4.8	SPI	2
Voltage input	DC5V	SD/MMC/SDIO	3
Working Temp	-40°C~ +85°C	USB	1x USB2.0 Device, 1x USB2.0 OTG
Package	edge soldering	PWM	3
Dimensions	52x 42mm	JTAG	1
PMIC	TPS65217C	EINT/GPIO	supported
GPU	PowerVR SGX530	ADC	7
Display	1x RGB888	IIS	1

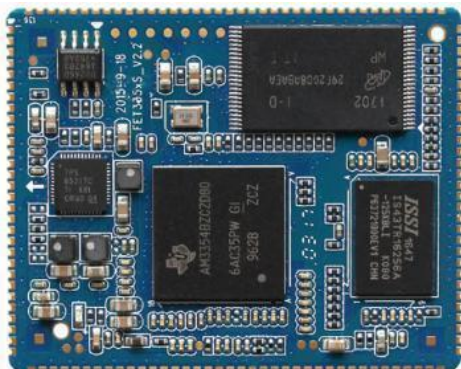

OK335xS Carrier Board Features

Display	1x RGB888	USB Host	4x USB2.0
Audio	1x Phone, 1x MIC, 1x Line in	USB OTG	1x USB2.0
Ethernet	2x 10/ 100/1000Mbps	ADC	8(4 for resistive touching, 4 for users)
UART	1, LVCOMS	PWM	2, 1 for backlight, 1 for buzzer
RS232	3(2x 3-wire, 1x debug)	RTC	supported
RS485	1, multiplexed with COM1	JTAG	1
CAN	1	EINT/GPIO	supported
IIC	2, suspended	Functional key	6
SPI	1	DIP	booting mode selection
SD/MMC/SDIO	1x SD	LED	1
Power input	DC5V		

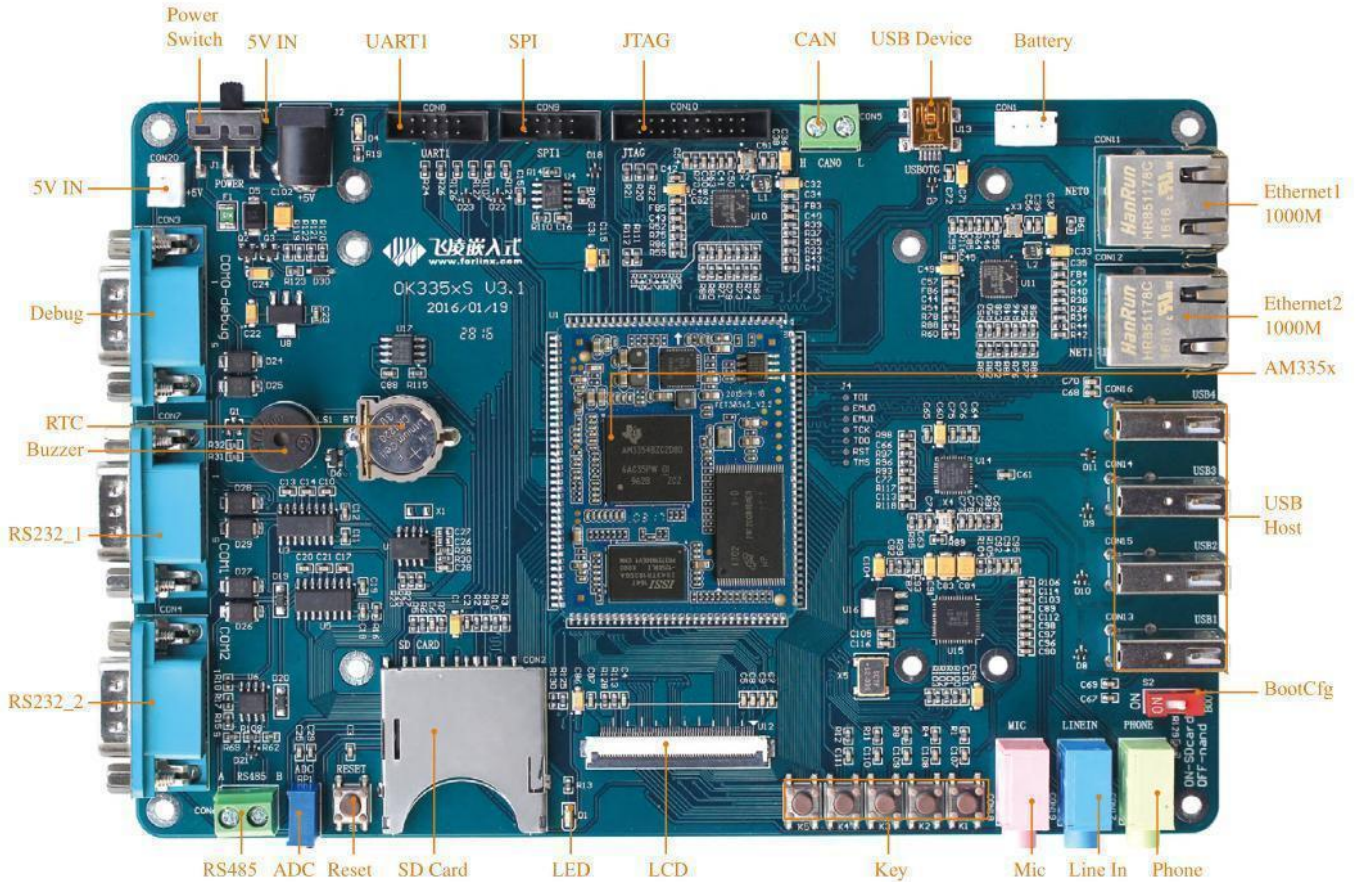



OVERVIEW



FET335xS-II system on module is based on AM3354 processor up to 600MHz, operating temperature ranges from -40°C to +85°C. It is simplified from FET335xS with lower cost.

SoM FET33xS Features

CPU	TI Sitara AM3354@ 600MHz	Ethernet	2x 10/ 100/ 1000Mbps
Architecture	Cortex-A8	UART	6
RAM	128MB DDR3	CAN	2
Flash	256MB NandFlash	IIC	3
OS	Win CE6.0, Linux3.2+QT4.8	SPI	2
Voltage input	DC5V	SD/MMC/SDIO	3
Working Temp	-40°C~ +85°C	USB	1x USB2.0 Device, 1x USB2.0 OTG
Package	edge soldering(136 pins, 1.27mm)	PWM	3
Dimensions	52x 42mm	JTAG	1
PMIC	TPS650250	EINT/GPIO	supported
GPU	PowerVR SGX530	ADC	7
Display	1x RGB888	IIS	1

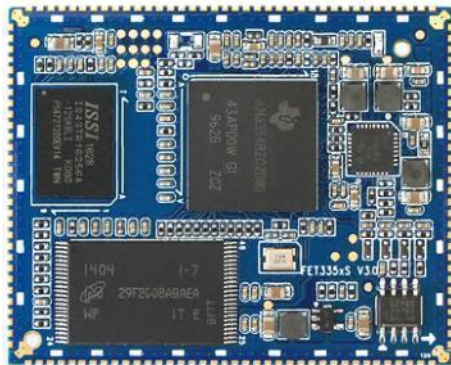

OK335xS-II Carrier Board Features

Display	1x RGB888	USB Host	1x USB2.0
Audio	1x Phone, 1x MIC, 1x Line in	USB OTG	1x USB2.0
Ethernet	1x 10/ 100Mbps	ADC	6(4 for resistive touching, 1 for users, 1 for slide rheostat)
UART	3, LVCOMS	PWM	1
RS232	1x debug	RTC	supported
RS485	1	EINT/GPIO	4
CAN	1(no transceiver)	Functional key	4
IIC	1	DIP	booting mode selection
SPI	1	LED	2
SD/MMC/SDIO	2(1x SD, 1x SDIO)	Power input	DC5V

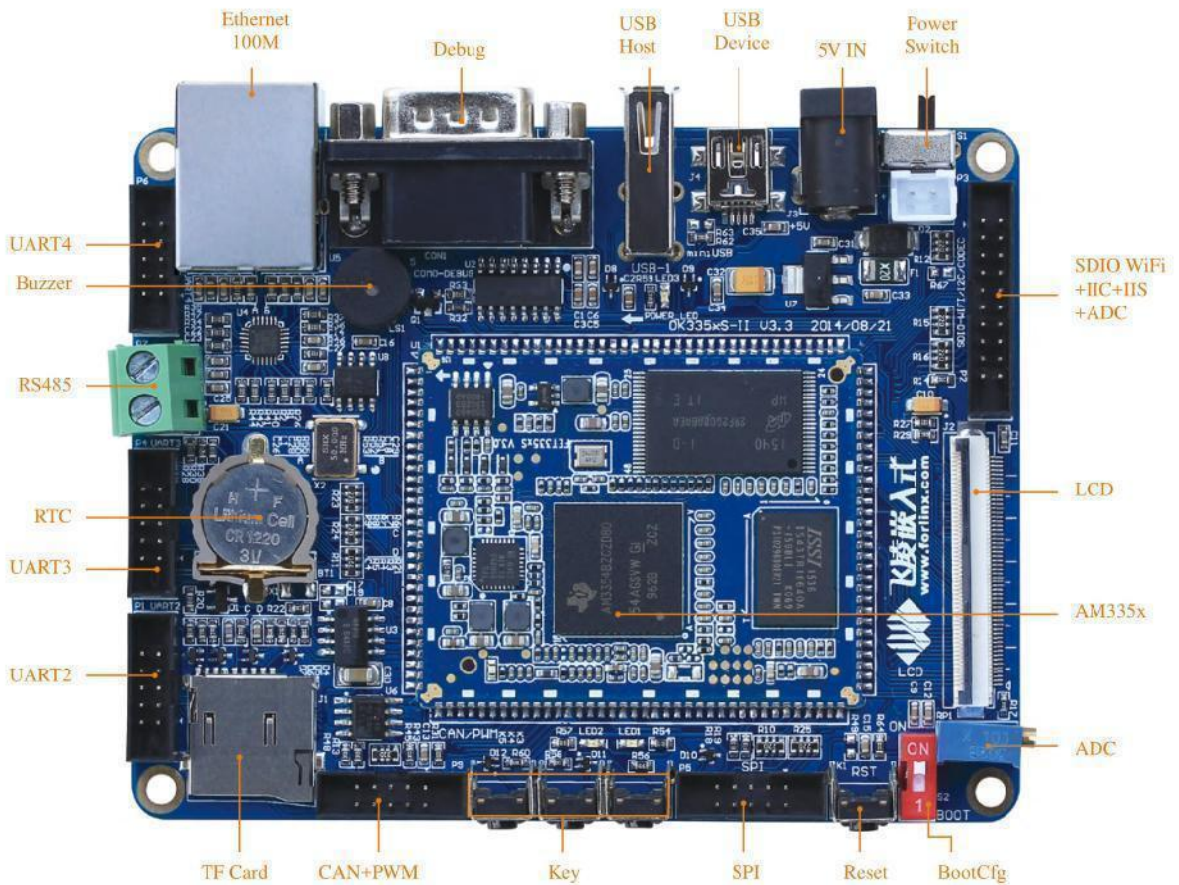

OVERVIEW

FET-G2LD-C SoM is designed based on G2L which is a hybrid processor contains a dual-core Cortex-A55 processor up to 1.2GHz and a Cortex-M33 core up to 200MHz and integrated with Mali-G31 GPU up to 500MHz, the SoM is pluggable and it could be connected to carrier board by three untra thin connectors, which is much more convenient for user's carrier board designing and also product maintenance. Besides, it has RS485 and CAN buses with EMC solution on carrier board, which is much preferable for field application.

SoM FET-G2LD Features

CPU	Renesas RZ/G2L (R9A07G044Lxx)	Ethernet	2x 10/ 100/ 1000Mbps IEEE802.3 PHY RGMII, IEEE802.3 PHY MII
Architecture	Cortex-A55+ M33	UART	5, support 16-byte FIFO
RAM	2GB DDR4(1GB optional)	CAN FD	2, CAN-FD ISO 11898-1(CD2014), up to 4Mbps
Flash	8GB eMMC	SD	1
OS	Linux4.19	Audio	4, IIS/ mono/ TDM
Voltage input	DC5V	IIC	3
Working Temp	-40°C~ +85°C	non-FIFO UART	2
Package	board-to-board connector	SPI	3
Dimensions	60x 38mm	MTU	9
Display	1x parallel RGB up to WXGA or 1x 4-lane MIPI-DSI	GPT	8
Camera	2x 4-lane MIPI CSI, 4000Mbps or 2x DVP	ADC	8
USB	1x USB 2.0 Host, 1x USB 2.0 OTG	WDT	3
QSPI	1	JTAG	supported

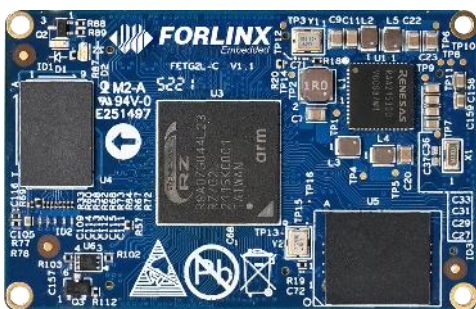

OK-G2L-C Carrier Board Features

MIPI-DSI	1x 4-lane MIPI-DSI	USB Host	2x USB2.0
MIPI CSI	1, by a 26-pin FPC connector	USB OTG	1x USB Type-C
Ethernet	2x 10/ 100/1000Mbps, RJ-45	SCIF(UART)	1, by 2.54mm headers
WiFi& BT	RL-UM02WBS-8723BU-V1.2 WiFi: IEEE 802.11b/g/n 2.4GHz BT: BT V2.1/BT V3.0/BT V4.0	SPI	3, by 2.54mm headers
4G	1, recommended model: EC20	ADC	8, by 2.54mm headers
QSPI	1	RS485	1, isolated
TF card slot	1	IIC	3
Audio	1, WM8960	JTAG	1, by 1.27mm headers
CAN	2x CAN-FD		

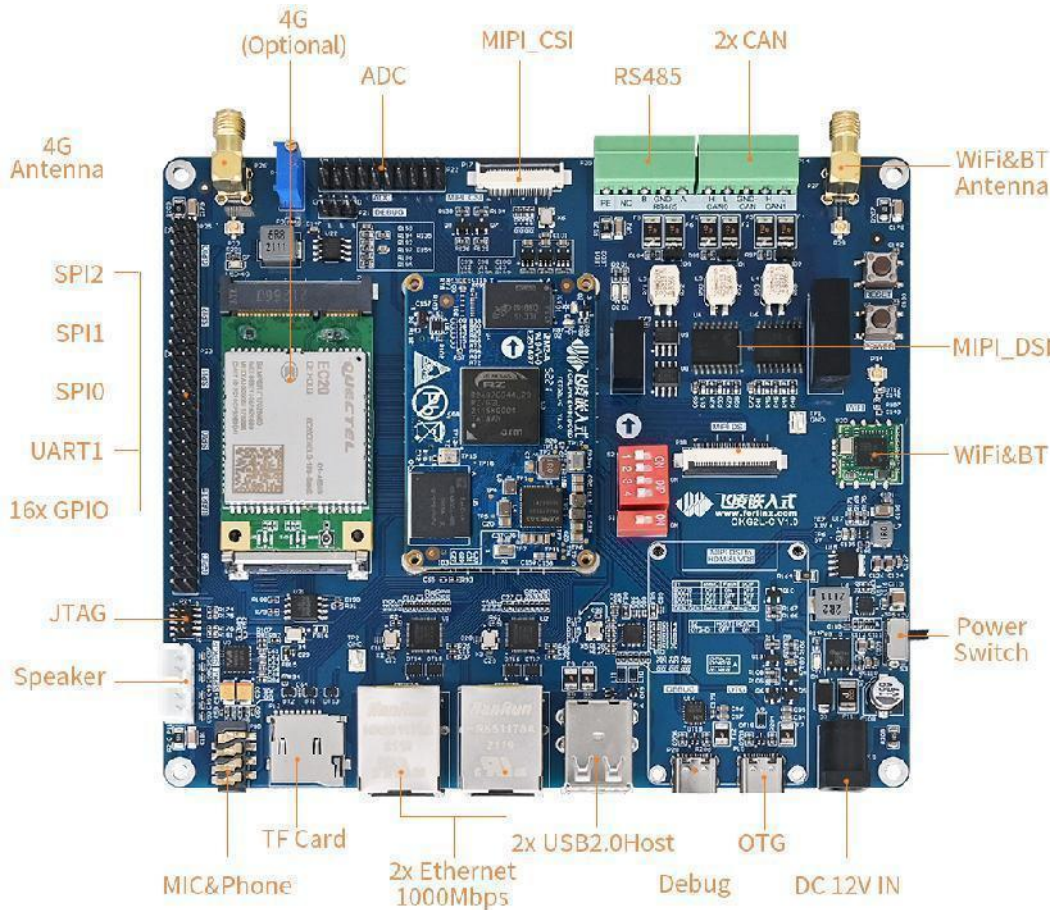

FCU1101 Embedded Computer

OVERVIEW



FCU1101 embedded computer is designed based on NXP i.MX6UL processor@528MHz, it has 256MB RAM and 256MB NAND Flash which could be upgraded to 1GB. Linux 3.14 is well supported with hardware float pointing. Prepherial interfaces such as RS485, Ethernet, WIFI, 4G, ZigBee/ LoRa are all available. It has stable performance under rough environment(-35 to +70 celsius degree).

FCU1101

CPU	Model: NXP i.MX6UltraLite Architecture: Cortex-A7 Frequency: 528MHz	RTC	CR2032, NTP is supported
RAM	256MB LvDDR3	Encryption	IIC, on-board encryption chip,suspended
Flash	256MB/1GB NandFlash	Watchdog	supported
Storage expand	TF card slot	LED	power indicator, system status indicator
Cellular	4G, EC20 from Quectel	Zigbee/LoRa	LoRa: E32-TTL-100, 433MHz; ZigBee: WLT2408NZ LoRa and ZigBee are alternative
Network	1x 10/ 100M Ethernet protocol: TCP/IP, UDP, DHCP, TFTP, FTP, Telnet, SSH, Web, HTTP, MQTT	RS485	4 isolation: signal, 1.5KV power isolation Protection: ESD4 Protocol: Modbus(RTU)
WiFi	RL-UM02WBS-8723BU, STA and AP both supported	Power input	DC12V, input range: DC9V~36V, antireverse and over-current protection
Reset	1	Dimensions	105mm x 100mm x 33mm
Boot key	can support Nand Flash and SD card booting modes	Mounting	fixed by screw
Environment	RH: 5% ~ 95%, non-condensing working temp: -35°C ~ +70°C storage temp: -40°C ~ +85°C	OS	OS: Linux 3.14 file system: Yaffs2 Compiler: arm-fsl-linux-gnueabi-gcc-4.6.2



FCU1103 Embedded Computer

OVERVIEW

FCU1103 embedded computer is also based on NXP i.MX6UL processor, it has various on-board hardware sources including 4x DI, 4x DO, 2x RS485, 2x CAN, 1x Ethernet, all are isolation designing. It can support WIFI, BT, 4G or GPRS wiress network. Compact outlines only 147mmx 100mmx 12mm easy for installation.

FCU1103

CPU	Model: NXP i.MX6UltraLite Architecture: Cortex-A7 Frequency: 528MHz	Audio	1x Headphone, 1x MIC(preserved with 3.5mm jack), 2 preserved connectors for speaker
RAM	256MB LvDDR3; 512MB LvDDR3	CAN	2, isolated
Flash	256MB NandFlash , 4/8GB eMMC	WiFi& BT	RL-UM02WBS-8723BU-V1.2
Ethernet	1(can be expanded to 2), 10/ 100M	UART	5
Storage expand	SD card slot, 64GB SDXC tested	RTC	CR2032 socket
Cellular	GPRS/4G, standard mini SIM card slot	USB	1x USB OTG, 1x USB Host
ESAM	ESAM, ISO7816	PSAM	mini SIM card slot
DO	4, relay output	DI	4, opticalcoupler isolation
Display	LVDS display, DVI-I connector	Power input	DC12V input range: DC9V~ 15V
Power failure	super capacitor solution can support system running 15S in once power failure	Dimensions	147mm x 103mm x 42mm
Mounting	by screw	OS	Linux3.14+QT4.8.5, Linux4.1.15+QT5.6 gcc-4.6.2-glibc-2.13-linaro-multibib-2011.12



FCU1104 Embedded Computer

OVERVIEW

FCU1104 embedded computer is designed based on NXP i.MX6UL L SoC(Cortex-A7) with advantages of cost efficient, advanced performance and high stability. It runs at speed of 792MHz, carries RAM 256MB and NandFlash 256MB(RAM 512MB, eMMC 4GB optional) on-board. Supported with OS Linux 4.1.15 complies various network protocols. It integrated with RS485/RS232, Ethernet, 4G, WiFi and LoRa all in one.

FCU1104

CPU	Model: NXP i.MX6UltraLite Architecture: Cortex-A7 Frequency: 800MHz	4G	EC200S, doesn't support GPS and audio
RAM	256MB DDR3; 512MB DDR3	WiFi	supports STA and AP(optional with 4G)
Flash	256MB NandFlash , 4/8GB eMMC	LoRa	1, 433MHz, 20dBm, 30dBm model: E32-TTL-100(433T20DC) 20dBm(deault) E22(400T30D) 30dBm
Ethernet	2, 10/ 100M, ESD3	Power input	DC12V input range: DC9V~ 36V
RS485	4 or 8, 1.5KV isolation, ESD4, one is multiplexed with RS232	RTC	CR2032 socket, NTP is supported
DI	2, dry contact input, isolated	OS	Linux4.1.15, files system: Yaffs2, GCC 4.6.2
DO	2, relay output, contacting capacity 5A 250VAC, 5A 30VDC	Dimensions	150mm x 110mm x 45mm
CAN	1, 1.5V isolation, ESD4	TF card	1, 32GB tested
Buzzer	1	Boot key	1, works together with reset to update firmware
Reset key	1	Environment	RH: 5% ~ +95%, non-condensing working temp: -25°C ~ +85°C(eMMC) 40°C ~ +85°C (NAND version) WiFi: 0°C ~ +70°C Storage: -40°C ~ +85°C



FCU1201 Embedded Computer

OVERVIEW

FCU1201 embedded computer is based on NXP i.MX6DL processor with main frequency up to 1GHz, it has 1GB RAM and 8GB eMMC, integrates with RS485, CAN, ESAM, PSAM, USB, Ethernet, 4G, WIFI, LVDS, HDMI, DI, DO, audio and other peripherals, which make it's widely used in EV charger, advertising machine, vending machine, security, car electronics, industrial control, power communication applications.

FCU1201

CPU	Model: NXP i.MX6Q/ i.MX6DL Architecture: Cortex-A53 Frequency: 1.0GHz	HDMI	mini PCIe socket, HDMIv1.4
RAM	1GB DDR3	Power failure	super capacitor can support system maintains 15s in case of power failure
Flash	8GB eMMC	UART	2(1x 3-wire debug port, 1x 3-wire card reader)
Storage expand	TF card, 64GB tested	RS485	2, electrical isolated
Cellular	4G, mini PCIe socket, mini SIM card slot	USB	1x USB2.0 OTG, 1x USB2.0 Host
ESAM	ISO7816	CAN	2, electrical isolated
PSAM	Mini SIM card slot	Ethernet	1x 10/ 100/ 1000M
DO	4, relay output	WiFi& BT	IEEE 802.11b/g/n 1T1R WLAN Bluetooth 2.1/3.0/4.0
DI	4, optical coupler isolated	RTC	CR2032
Audio	1x Headphone, 1x MIC, 2x Speaker, preserved	Voltage input	DC12V (9V~ 36V)
LVDS	DVI-I connector	Dimensions	147mm x 103mm x 42mm
OS	Linux3.0.35+QT4.8.5, Android6.0	Mounting	4x Φ4mm screw nails



FCU2201 Embedded Computer

OVERVIEW

The FCU2201 is designed for industrial data acquisition and processing applications. It supports 5G, 4G, Ethernet, dual-band Wi-Fi, RS485, RS232 and other functions and interfaces. It can be used for uplink network access and connection of downlink sensors and other devices; it adopts ARM Cortex-A53 architecture processor with a main frequency up to 1GHz, can meet the performance requirements of local data processing, edge computing, etc.

FCU2201

CPU	LS1012A, Cortex-A53, 1.0GHz
RAM	512MB
Flash	8GB eMMC
Voltage input	9V~ 36V, with anti-reverse, ESD, surge and pulse protection
Working temp	-40°C~+80°C
OS	Ubuntu18.04, OpenWRT
Mounting	Din rail or wall mounting
Storage expand	TF card
Cellular	M.2, can support 5G or 4G module network connectivity
Ethernet	2x 10/ 100/ 1000Mbps, auto-negotiation
WiFi	PCIe by M.2 E Key socket, dual-band WiFi
RS485/ RS232	1, RS485 and RS232 are multiplexed, with ESD, surge and pulse protection
RS485	4, with ESD, surge and pulse protection
RTC	can support NTP
Protocol	TCP, UDP, NTP, DHCP, SSH, FTP, Docker, Python, SQLite



FCU2303 Embedded Computer

OVERVIEW

FCU2303 is a fanless 5G industrial gateway solution with advanced computing performance based on NXP LS1043A , LS1046A running up to 1.8GHz. It has 8 Gigabit Ethernet ports each with separate MAC and 8 RS485(4 are multiplexed with RS232 and RS485) and could be widely used in smart city, factory, water utility, agricultrue, securiety monitoring, etc. Open software supporting of Ubunut 18.04 integrated with third party clusters.

FCU2303

CPU	FCU2303 based on FET1046A-C, Cortex-A72, 1.8GHz; FCU2303 based on FET1043A-C, Cortex-A53, 1.6GHz
RAM	2GB DDR4
Flash	8GB eMMC, 16MB QSPI NorFlash
Voltage input	12V5A, with anti-reverse protection
Working	RH: 5%~ 95% non-condensing, working: -40°C ~ +85°C, storage: -40°C ~ +125°C
OS	Ubuntu18.04, OpenWRT
Cellular	5G module: RM500Q-GL, 4G module: EC20
Storage expand	1x M.2 M Key, can support NVME PCIe hard disk, tested model: INTEL 760P
Ethernet	8 Gigabit Ethernet ports, RJ45 connectors, 10/ 100/ 1000Mbps auto-negotiation
WiFi	M.2 Type 2230, M.2 E Key, tested model: INTEL 3168NGW
DO	2x relay output, contact capacity: 5A 30VDC / 5A 250VAC, 3.81mm green terminals
DI	2, optical coupler isolated, 3.81mm green terminals
RTC	CR2032
USB3.0	1x USB 3.0 Host, USB Type-A connector, for system flashing
Dimensions	231.9mm x 53mm x 155mm



FCU2401 Embedded Computer

OVERVIEW

FCU2401 embedded computer is based on Allwinner Cortex -A7 featuring quad-core processor A40i running at 1.2GHZ, it integrates with MAli400MP2 GPU, RAM 1GB(2GB upgradable) and 8GB eMMC. It has a variety of peripheral sources, such as RS485, CAN, ESAM, USB, Ethernet, 4G, WiFi, GPS, LVDS, HDMI , DI , DO , audio and SATA. All communication interfaces are designed with isolation protection solution and tested by ESD4. It can support dual-screen playing. Applicable for edge computing, EV charger,

FCU2401

CPU	A40i, Cortex-A7, 1.2GHz	4G	EC20, dual SIM card slots
RAM	1GB DDR3L	WiFi	STA and AP are both supported
Flash	8GB eMMC	USB Host	2x USB2.0 Host, ESD4
Ethernet	2, 1x 10/ 100Mbps, 1x 10/ 100/ 1000Mbps, ESD4, EFT3	USB OTG	for system installation and debug
RS485	2, 3KV isolation, ESD4, EFT3	RTC	CR2032
RS232	2, 3KV isolation, ESD4, EFT3, contains one debug port, and the other one is isolated from 5V output, 1W	ESAM	ISO7816
DO	4x relay output contact: 5A 250VAC, 5A 30VDC	Hard disk	2.5'' SATA disk
DI	4x dry contact input	DIP	DC12V, with anti-reverse and over current protection
CAN	2, 2.5KV signal isolation, 3KV power isolation, ESD4, EFT3	Voltage input	fixed by screw
GPS	BDS& GPS dual-mode	Power failure	super capacitor can support 15s system maintainance
HDMI	1x HDMIv1.4, 1080P@ 60FPS	Reset	1
LVDS	standard DVI-I connector	BOot key	used together with reset key for firmware updating
TV IN	2, can support NTSC and PAL	LED	2, indicates whether it's powered by external source or supper capacitor
Audio	1x speaker, 4Ω 1W speaker	Environment	RH: 5% ~ 95%, non-condensing working: -40°C ~ +80°C storage: -40°C ~ +85°C



FCU3001 AI Computing Box

OVERVIEW

FCU3001 AI computing box is designed specially for edge computing related applications, it's based on NVIDIA® Jetson Xavier™ NX SoC a 6-core Carmel ARM up to 1.4GHz. It's integrated with 384 Core Volta GPU and deep learning accelerator engine up to 21 TOPS, can support neural network and can process data from multiple high resolution sensors. A variety of peripheral interface are available and ready-to-use such as 5G/ 4G, CAN, WiFi, USB3.0, RS485 Gigabit Ethernet, HDMI, etc.

FCU3001

AI capability	21 TOPS	RS232/RS485	1
CPU	6 Core ARM® Carmel®V8.2 64-bit	4G/5G	1
RAM	16GB LPDDR4x	CAN	1
Flash	16GB eMMC + MicroSD card expansion	DI/ DO	2x DI, 2x DO
OS	Ubuntu18.04.5 LTS	TF card slot	1
Voltage input	12-24V	Reset	1
Ethernet	4x 10/ 100/1000Mbps	M.2 SSD	1, NVME hard disk
Camera	2x MIPI CSI-2 D-PHY lanes	WiFi	1, 2.4G/ 5G dual band WiFi, STA and AP are both supported
GPU	NVIDIA Volta™, carries 384 NVIDIA® CUDA® cores and 48 Tensor cores	USB	2x USB2.0 2x USB3.0
USB OTG	1, for system installation	HDMI2.0	1
Video encode	2x 4K60 4x 4K30 10x 1080p60 22x 1080p30(H.265) 2x 4K60 4x 4K30 10x 1080p60 20x 1080p30(H.264)	Video decode	2x 8K30 6x 4K60 12x 4K30 22x 1080p60 44x 1080p30 (H.265) 2x 4K60 6x 4K30 10x 1080p60 22x 1080p30(H.264)



Follow us

