



SPECIFICATION SHEET

SPECIFICATION SHEET NO.	Q1030-1SMA4747AS747A	
DATE	Oct. 30, 2023	
REVISION	A0	Updated With Most Recent Data - Official First Release
DESCRIPTION AND MAIN PARAMETRICS	<p>SMD Zener Diodes, DO-214AC/SMA, 1SMA series, 1SMA4747A Type, 2 Pads Voltage - Zener (Nom) (Vz): 20V, Peak Pulse Power: 1.0 Watts Operating Temp. Range -55°C ~+150°C Package in Tape/Reel, 5000pcs/Reel RoHS III/REACH Compliant and Halogen Free (HF)</p>	
CUSTOMER		
CUSTOMER PART NO.		
CROSS REF. PART NO.		
ORIGINAL MFG/PART NO.	MDD/1SMA4747A	
PART CODE	1SMA4747AS747A	

VENDOR APPROVE			
Issued/Checked/Approved			
DATE: Oct. 30, 2023			

CUSTOMER APPROVE	
DATE:	

SMD ZENER DIODES 1SMA SERIES

MAIN FEATURE

- Low Profile Package
- Built-in Strain Relief
- Glass Passivated Junction
- Low Inductance
- 1.0W Peak Pulse Power
- Typical IR Less Than 5.0μA Above 11V
- High Temperature Soldering Guaranteed: 260°C/10 Seconds At Terminals
- Plastic Package Has Underwriters Laboratory Flammability 94V-0
- REACH/RoHS III Complaint and Halogen Free
- Cross Main Competitor Parts in Market



APPLICATION

- For SMD application

RFQ

[Request For Quotation](#)

PART CODE GUIDE

1SMA	4747A	S	747A
1	2	3	4

1. 1SMA: SMD Zener SERIES Diodes, Package Case DO-214AC/SMA, 1SMA series
2. 4747A: Specification code for Voltage - Zener (Nom) (Vz): 20V
3. S: Package code, Tape/Reel
4. 747A: Marking code for “747A” on the case surface, Different Marking for different specification

ELECTRICAL CHARACTERISTICS

See Page 5 ~ Page 7 For Different Part Code

HOW TO ORDER

Please indicate part code and send us your RFQ by E-mail, sales@nextgencomponent.com

SMD ZENER DIODES 1SMA SERIES

DIMENSION - Unit: Inch/mm

Image for reference



Marking: Standard

* See Marking Code List

page 5~ Page 7

Case Dimension:
SMA/DO-214AC

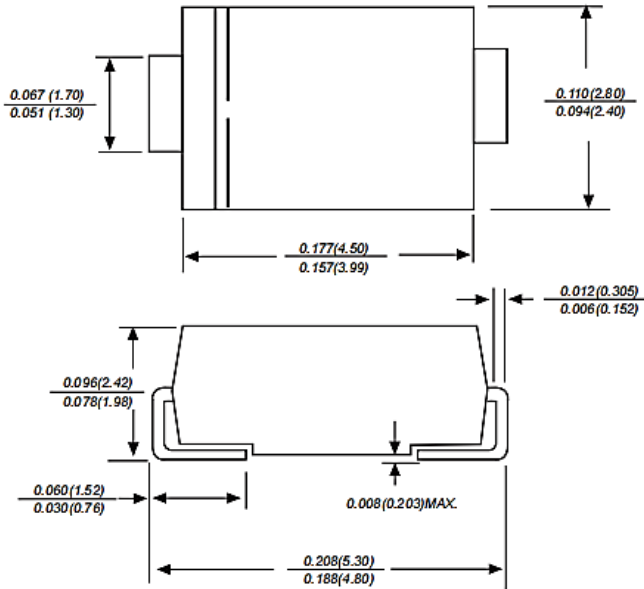

Recommend Pad Layout

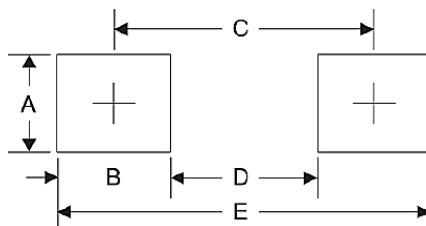

Symbol	Unit (Inch)	Unit (mm)
A	0.066	1.680
B	0.060	1.520
C	0.154	3.900
D	0.095	2.410
E	0.215	5.450

SMD ZENER DIODES 1SMA SERIES

MECHANICAL DATA

Case	Terminals	Polarity	Mounting Position	Marking	Weight per piece
JEDEC SMA/DO-214AC molded plastic body	Solderable per MIL-STD-750, Method 2026	Polarity symbol marking on body	ANY	See Marking Code List (Page 5~Page 7)	0.0019 ounce, 0.055 grams

MAX. RATING & CHARACTERISTICS - Ratings at 25°C Ambient Temperature Unless Otherwise Specified.

Parameter	SYMBOLS	VALUE	UNITS
Peak Pulse Power Dissipation at TA=50°C Derate above 50°C (Note 1)	P D	1.0 6.67	W mW/°C
Peak Forward Surge Current, 8.3ms Single Half Sine-wave Superimposed On Rated Load, (JEDEC Method) (Note 2)	I FSM	10.0	A
Forward Voltage @ I FSM	V F	1.2	V
Operating Junction Temperature Range	T J	-55 ~ +150	°C
Storage Temperature Range	T stg	-55 ~ +150	°C

Notes

1. Mounted on 5.0mm² (0.013mm thick) land Area.
2. Measured on 8.3ms Single Half Sine Wave Or Equivalent Square Wave, Duty Cycle=4 Pulses Per Minute Max.

SMD ZENER DIODES 1SMA SERIES
ELECTRICAL CHARACTERISTICS UNIDIRECTIONAL TYPE - Ta = 25°C

Part Code	Zener Voltage Range (See Note 1) V _{ZT} @ I _{ZT} (V)			Test Current I _{ZT} (mA)	Dynamic Impedance Max. Z _{ZT} @ I _{ZT} (Ω)	Reverse Current		Admissible Zener Current I _{ZM} (mA)	Marking Code
	Min.	Nom	Max.			Max. I _R (μA)	@ V _R (V)		
1SMA4728AS728A	3.1	3.3	3.5	75	10	100	1	285	728A
1SMA4729AS729A	3.4	3.6	3.8	69	10	100	1	263	729A
1SMA4730AS730A	3.7	3.9	4.1	64	9	50	1	243	730A
1SMA4731AS731A	4.06	4.3	4.56	58	9	25	1	219	731A
1SMA4732AS732A	4.5	4.7	4.93	53	8	10	1	203	732A
1SMA4733AS733A	4.84	5.1	5.36	49	7	10	1	186	733A
1SMA4734AS734A	5.32	5.6	5.92	45	5	10	2	170	734A
1SMA4735AS735A	5.86	6.2	6.51	41	2	10	3	154	735A
1SMA4736AS736A	6.46	6.8	7.18	37	3.5	10	4	140	736A
1SMA4737AS737A	7.12	7.5	7.88	34	4	10	5	127	737A
1SMA4738AS738A	7.79	8.2	8.67	31	4.5	10	6	116	738A
1SMA4739AS739A	8.6	9.1	9.59	28	5	10	7	104	739A
1SMA4740AS740A	9.5	10	10.5	25	7	10	7	95	740A
1SMA4741AS741A	10.4	11	11.6	23	8	5	8	86	741A
1SMA4742AS742A	11.4	12	12.6	21	9	5	9	79	742A
1SMA4743AS743A	12.4	13	14.1	19	10	5	10	71	743A
1SMA4744AS744A	13.8	15	15.8	17	14	5	11	63	744A
1SMA4745AS745A	15.2	16	17.1	16	16	5	12	58	745A
1SMA4746AS746A	16.8	18	19.2	14	20	5	13	52	746A
1SMA4747AS747A	19	20	21.2	13	22	5	15	47	747A
1SMA4748AS748A	20.8	22	23.3	12	23	5	17	43	748A

SMD ZENER DIODES 1SMA SERIES
ELECTRICAL CHARACTERISTICS UNIDIRECTIONAL TYPE - Ta = 25°C

Part Code	Zener Voltage Range (See Note 1) V _{ZT} @ I _{ZT} (V)			Test Current I _{ZT} (mA)	Dynamic Impedance Max. Z _{ZT} @ I _{ZT} (Ω)	Reverse Current		Admissible Zener Current I _{ZM} (mA)	Marking Code
	Min.	Nom	Max.			Max. I _R (μA)	@ V _R (V)		
1SMA4749AS749A	22.8	24	26	11	25	5	18	38	749A
1SMA4750AS750A	25.3	27	28.9	9.5	35	5	21	35	750A
1SMA4751AS751A	28.2	30	32	8.5	40	5	23	31	751A
1SMA4752AS752A	31.3	33	34.9	7.5	45	5	25	28	752A
1SMA4753AS753A	34.2	36	37.9	7	50	5	27	26	753A
1SMA4754AS754A	37.2	39	41.5	6.5	60	5	30	24	754A
1SMA4755AS755A	40.9	43	45.6	6	70	1	32	22	755A
1SMA4756AS756A	44.9	47	49.8	5.5	80	1	35	20	756A
1SMA4757AS757A	48.6	51	54	5	95	1	38	18	757A
1SMA4758AS758A	53.6	56	58.8	4.5	110	1	42	17	758A
1SMA4759AS759A	58.9	62	65.6	4	125	1	47	15	759A
1SMA4760AS760A	64.6	68	71.7	3.7	150	1	52	14	760A
1SMA4761AS761A	71.2	75	78.8	3.3	175	1	56	12	761A
1SMA4762AS762A	77.9	82	87	3	200	1	62	11	762A
1SMA4763AS763A	86	91	96	2.8	250	1	69	10	763A
1SMA4764AS764A	95	100	105	2.5	350	1	76	9.5	764A
1SMA4765AS765A	104	110	116	2.3	450	1	84	8.6	765A
1SMA4766AS766A	114	120	127	2	550	1	91	7.8	766A
1SMA4767AS767A	125	135	142	1.9	700	1	100	7	767A
1SMA4768AS768A	140	150	157	1.7	900	1	110	6.3	768A
1SMA4769AS769A	155	165	172	1.6	1100	1	120	5.8	769A

SMD ZENER DIODES 1SMA SERIES
ELECTRICAL CHARACTERISTICS UNIDIRECTIONAL TYPE - Ta = 25°C

Part Code	Zener Voltage Range (See Note 1) V _{ZT} @ I _{ZT} (V)			Test Current I _{ZT} (mA)	Dynamic Impedance Max. Z _{DT} @ I _{ZT} (Ω)	Reverse Current		Admissible Zener Current I _{ZM} (mA)	Marking Code
	Min.	Nom	Max.			Max. I _R (μA)	@ V _R (V)		
1SMA4770AS770A	170	180	191	1.4	1200	1	135	5.2	770A
1SMA4771AS771A	189	200	211	1.2	1400	1	150	4.7	771A
1SMA4772AS772A	209	220	231	1	1600	1	165	4.3	772A
1SMA4773AS773A	229	240	251	1	1800	1	180	3.9	773A
1SMA4774AS774A	249	260	271	1	2000	1	190	3.7	774A
1SMA4775AS775A	269	280	291	1	2100	1	205	3.4	775A
1SMA4776AS776A	289	300	315	1	2300	1	230	3.1	776A
1SMA4777AS777A	313	330	346	1	2500	1	250	2.8	777A

Notes 1: V_{ZT} is tested with pulses (20 ms)

RATINGS AND CHARACTERISTIC CURVES (For Reference Only) - $T_a = 25^\circ\text{C}$ Unless Otherwise Specified

Figure 1. Power Temperature Derating Curve

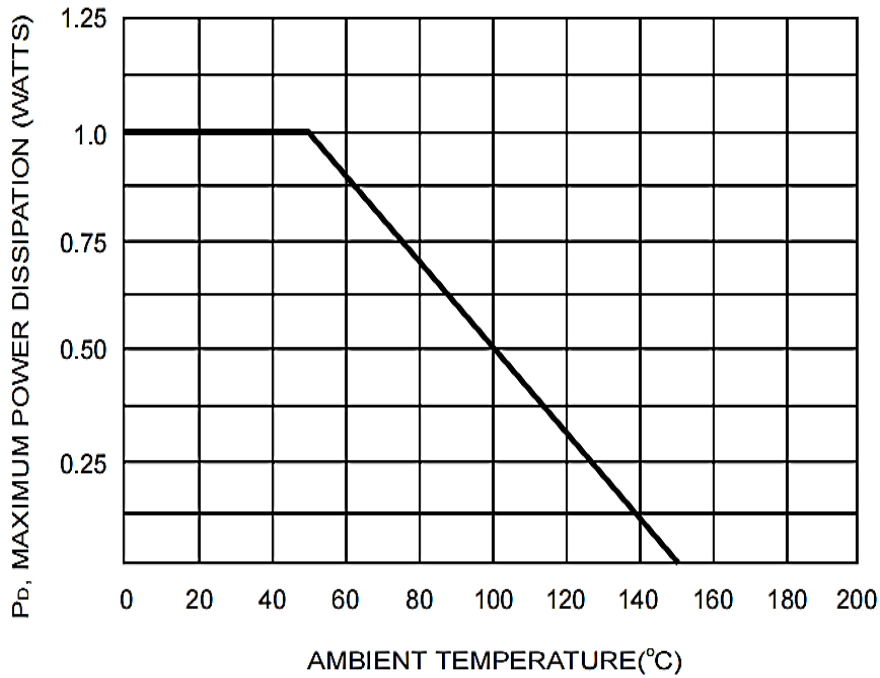
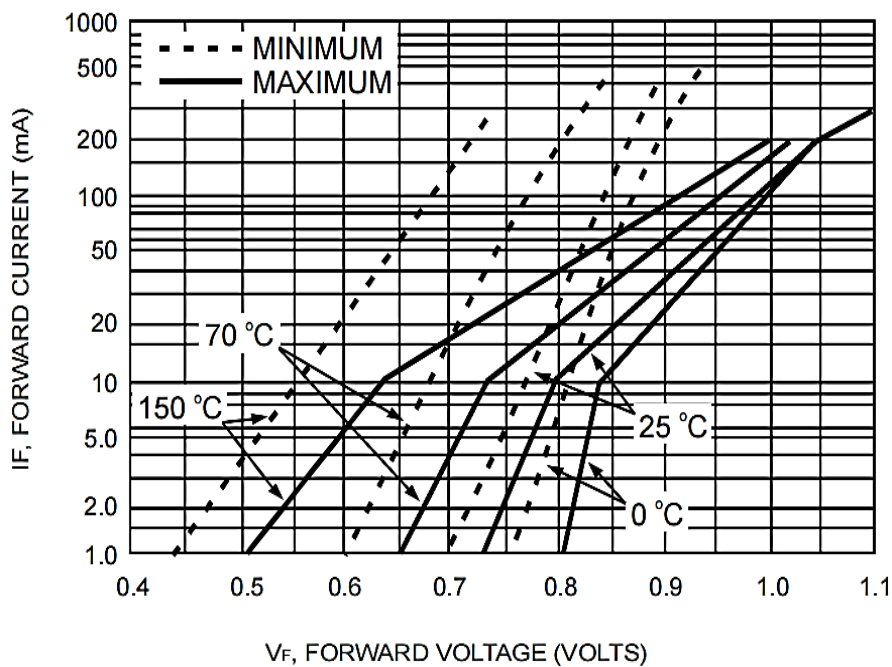

Figure 2. Typical Forward Characteristics Curve



SMD ZENER DIODES 1SMA SERIES

RATINGS AND CHARACTERISTIC CURVES (For Reference Only) - $T_a = 25^\circ\text{C}$ Unless Otherwise Specified

Figure 3. Effect Of Zener Current On Zener Impedance Curve

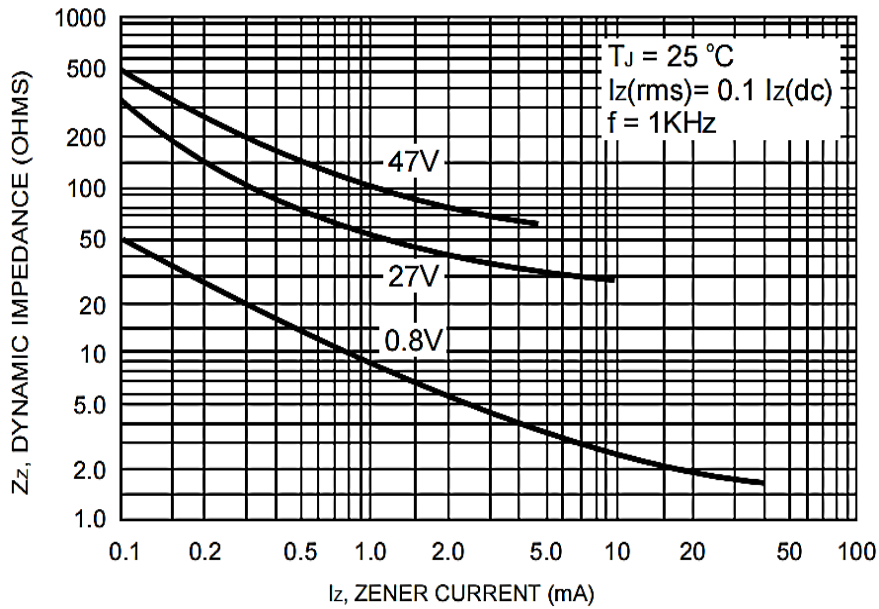
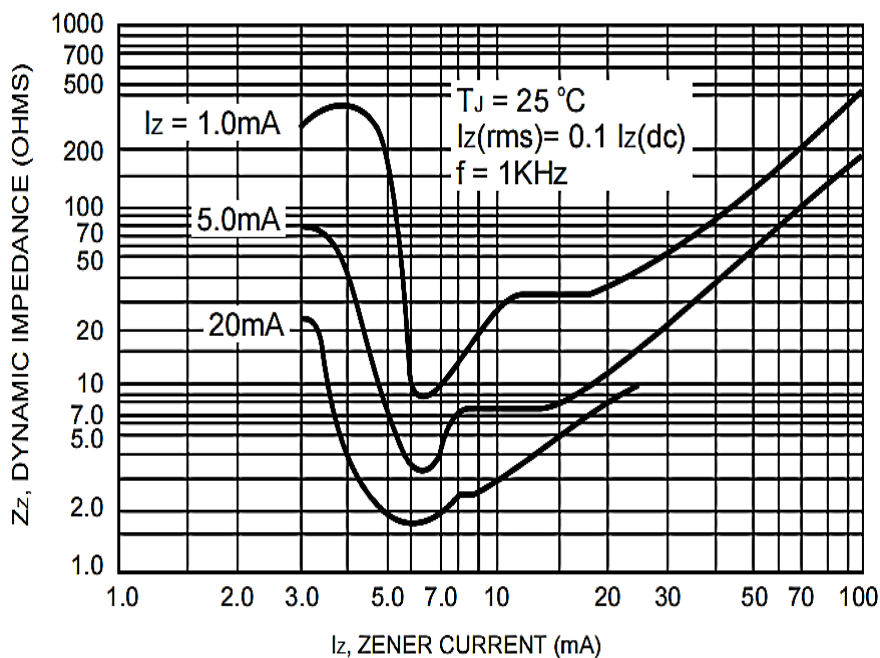

Figure 4. - Effect Of Zener Voltage On Zener Impedance Curve



SMD ZENER DIODES 1SMA SERIES

RATINGS AND CHARACTERISTIC CURVES (For Reference Only) - Ta= 25°C Unless Otherwise Specified

Figure 5. Typical Leakage Current Curve

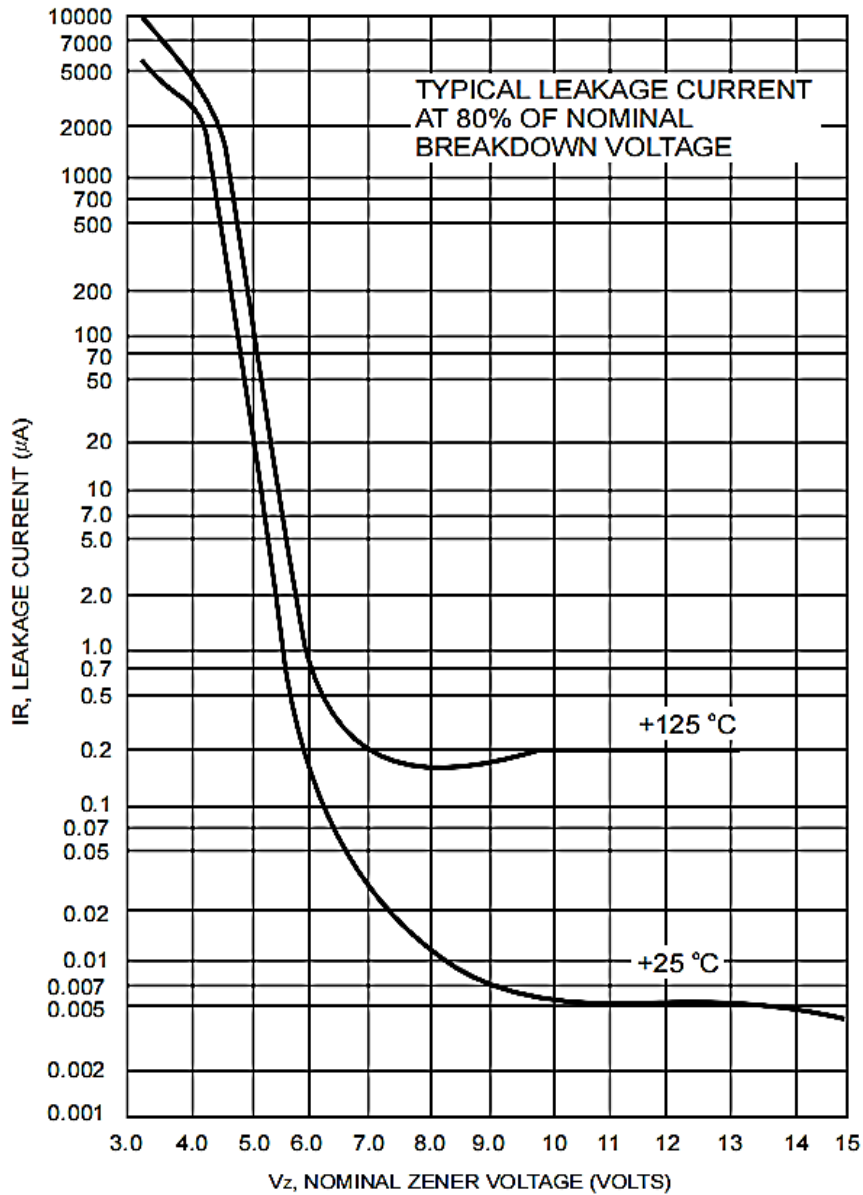

RATINGS AND CHARACTERISTIC CURVES (For Reference Only) - $T_a = 25^\circ\text{C}$ Unless Otherwise Specified

Figure 6. Typical Capacitance versus V_z Curve

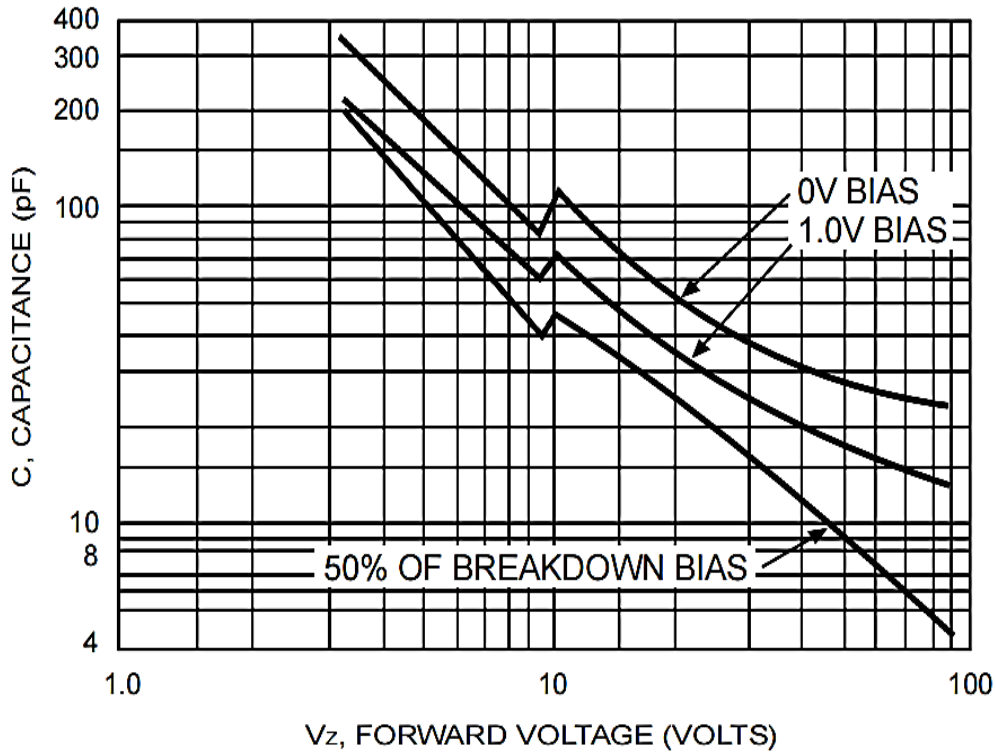
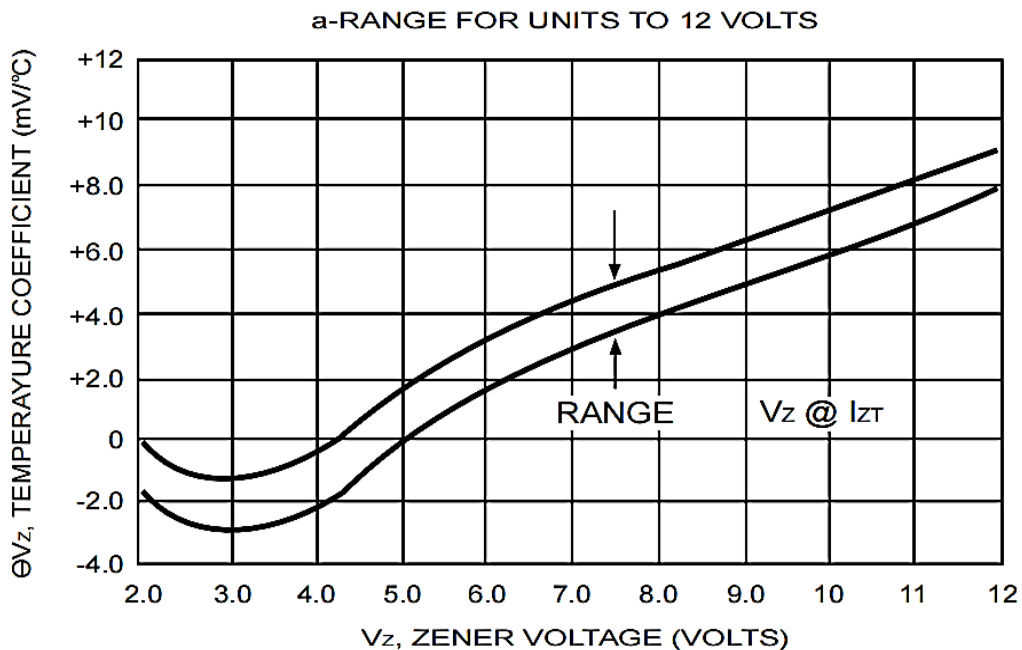

Figure 7. Temperature Coefficients Curve



SMD ZENER DIODES 1SMA SERIES

RATINGS AND CHARACTERISTIC CURVES (For Reference Only) - $T_a = 25^\circ\text{C}$ Unless Otherwise Specified

Figure 8. Temperature Coefficients Curve

b-RANGE FOR UNITS 12 TO 100 VOLTS

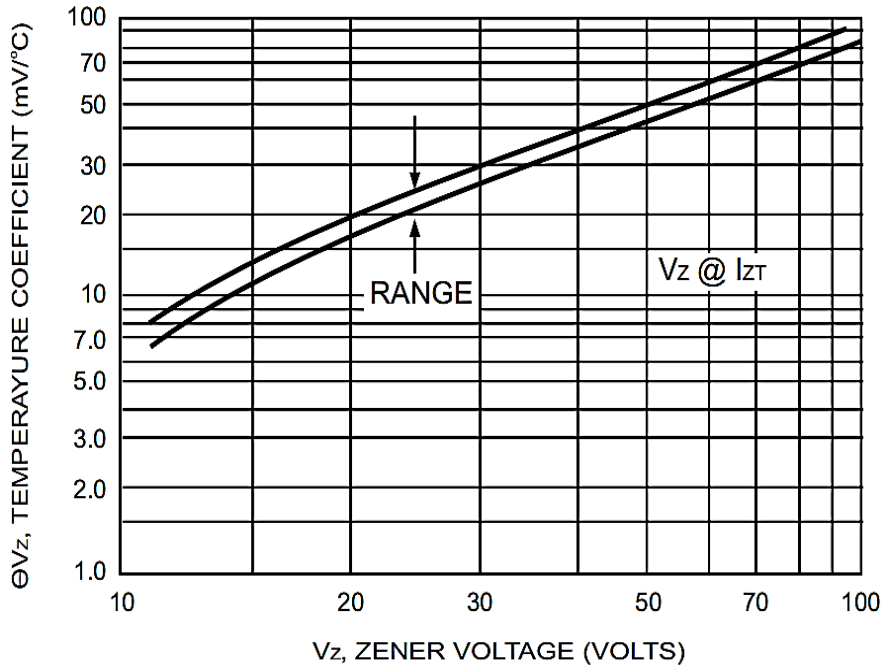
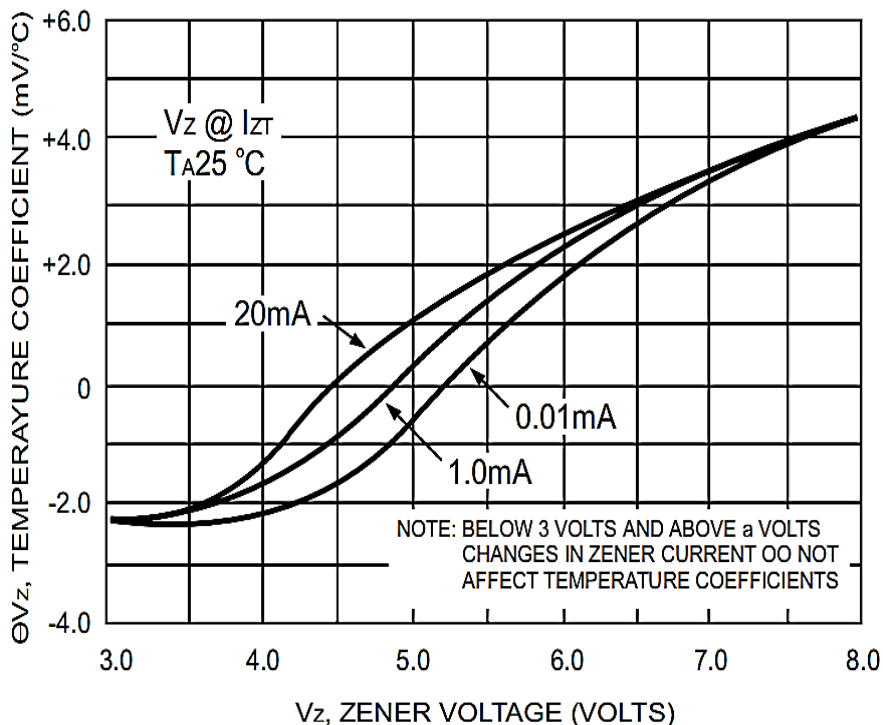

Figure 9. Effect Of Zener Current Curve



SMD ZENER DIODES 1SMA SERIES

RATINGS AND CHARACTERISTIC CURVES (For Reference Only) - $T_a = 25^\circ\text{C}$ Unless Otherwise Specified

Figure 10. Maximum Surge Power Curve

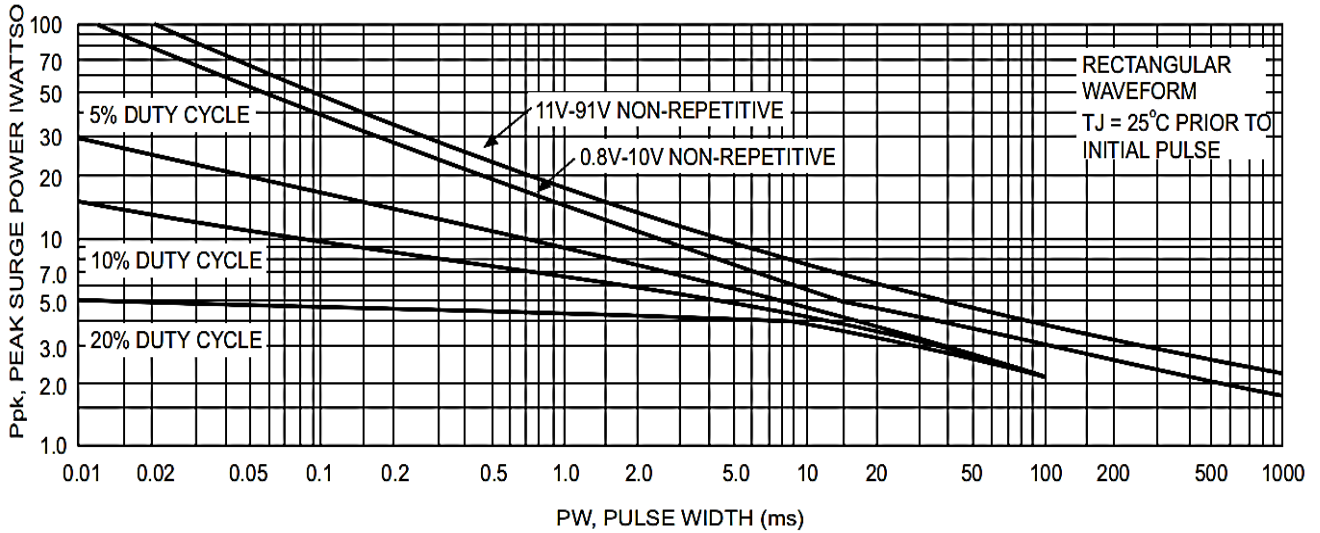

SMD ZENER DIODES 1SMA SERIES
RELIABILITY

Number	Experiment Items	Experiment Method And Conditions	Reference Documents
1	Solder Resistance Test	Test 260°C± 5°C for 10 ± 2 sec. Immerse body into solder 1/16" ± 1/32"	MIL-STD-750D METHOD-2031.2
2	Solderability Test	230°C ±5°C for 5 sec.	MIL-STD-750D METHOD-2026.1 0
3	Pull Test	1 kg in axial lead direction for 10 sec.	MIL-STD-750D METHOD-2036.4
4	Bend Test	0.5Kg Weight Applied To Each Lead, Bending Arcs 90 °C ± 5 °C For 3 Times	MIL-STD-750D METHOD-2036.4
5	High Temperature Reverse Bias Test	TA=100°C for 1000 Hours at VR=80% Rated VR	MIL-STD-750D METHOD-1038.4
6	Forward Operation Life Test	TA=25°C Rated Average Rectified Current	MIL-STD-750D METHOD-1027.3
7	Intermittent Operation Life Test	On state: 5 min with rated IRMS Power Off state: 5 min with Cool Forced Air. On and off for 1000 cycles.	MIL-STD-750D METHOD-1036.3
8	Pressure Cooker Test	15 PSIG, TA=121°C, 4 hours	MIL-S-19500 APPENOIXC
9	Temperature Cycling Test	-55°C~+125°C; 30 Minutes For Dwelled Time 5 minutes for transferred time. Total: 10 cycles.	MIL-STD-750D METHOD-1051.7
10	Thermal Shock Test	0°C for 5 minutes., 100°C for 5minutes, Total: 10 cycles	MIL-STD-750D METHOD-1056.7
11	Forward Surge Test	8.3ms Single Sale Sine-wave One Surge.	MIL-STD-750D METHOD-4066.4
12	Humidity Test	TA=65°C, RH=98% for 1000 hours.	MIL-STD-750D METHOD-1021.3
13	High Temperature Storage life Test	150°C for 1000 Hours	MIL-STD-750D METHOD-1031.5

SMD ZENER DIODES 1SMA SERIES

SUGGESTED REFLOW PROFILE - For Reference Only



Profile Feature		Pb-Free Assembly
Average Ramp-up Rate (Ts Max to Tp)		3°C/second Max
Preheat	Temperature Min (Ts Min.)	150°C
	Temperature Max (Ts Max.)	200°C
	Time (ts Min. to ts Max.)	60 ~ 180 seconds
Time maintained above	Temperature (Tl)	217°C
	Time (tl)	60 ~ 150 seconds
Peak/Classification Temperature (Tp)		260 °C
Time within 5°C of actual Peak Temperature (tp)		20 ~ 40 seconds
Ramp-down rate		6 °C /Second Max.
Time 25 °C to Peak Temperature		8 minutes Max.
Suggest reflow times		3 Times Max.

SMD ZENER DIODES 1SMA SERIES
TAPE/REEL (Unit: mm)

All Devices are packed in accordance with EIA standard RS-481-A and Tape 12mm, Component Spacing 4.0mm

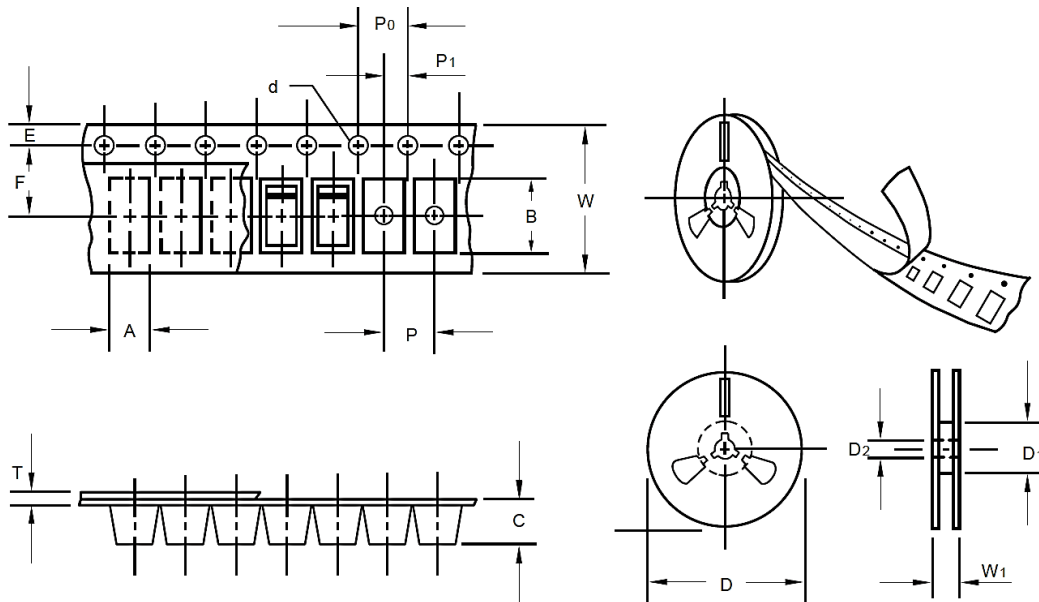

Item	Symbol	Tolerance	SMA/DO-214AC
Carrier width	A	0.1	2.8
Carrier Length	B	0.1	5.33
Carrier Depth	C	0.1	2.36
Sprocket hole	d	0.05	1.50
13"Reel outside diameter	D	2.0	330.0
13"Reel inner diameter	D1	-	50.0Min.
7"Reel outside diameter	D	-	-
7"Reel inner diameter	D1	-	-
Feed hole diameter	D2	0.5	13.00
Sprocket hole position	E	0.1	1.75
Punch hole position	F	0.1	5.50
Punch hole pitch	P	0.1	4.00
Sprocket hole pitch	P0	0.1	4.00
Embossment center	P1	0.1	2.0
Overall tape thickness	T	0.1	0.28
Tape width	W	0.3	12.00
Reel width	W1	1.0	18.0

ROHS COMPLIANCE

- The levels of RoHS restricted materials in this product are below the maximum concentration values (also referred to as the threshold limits) permitted for such substances, or are used in an exempted application, in accordance with EU RoHS Directive (EU) 2015/863 EC (RoHS3). [RoHS Test Report](#) for this product can be obtained after clicked.

REACH COMPLIANCE

- REACH substances of high concern (SVHCs) information is available for this product. Since the European Chemical Agency (ECHA) has published notice of their intent to frequently revise the SVHC listing for the foreseeable future, [REACH Test Report](#) for this product can be obtained after clicked.

IMPORTANT NOTES AND DISCLAIMER

1. All Product parametric performance is indicated in the Electrical Characteristics for the listed herein test conditions, unless otherwise noted. Product performance may not be indicated by the Electrical Characteristics if operated under different conditions.
2. NextGen Component, Inc (*NextGen*) reserves the right to make changes to this document and its products and specifications at any time without notice. Customers should obtain and confirm the latest product information and specifications before final design, purchase or use.
3. *NextGen* makes no warranty, representation or guarantee regarding the suitability of its products for any particular purpose, nor does NextGen assume any liability for application assistance or customer product design.
4. *NextGen* does not warrant or accept any liability with products which are purchased or used for any unintended or unauthorized application. No license is granted by implication or otherwise under any intellectual property rights of NextGen.
5. *NextGen* products are not authorized for use as critical components in life support devices or systems without express written approval by *NextGen*.
6. *NextGen* requires that customers first obtain an RMA (Returned Merchandise Authorization) number prior to returning any products. Returns must be made within 30 days of the date of invoice, be in the original packaging, unused and like-new condition. At the time of quoting or purchasing, a product may say that it is Non-Cancelable/ Non-Returnable (NCNR). These products are not returnable and not refundable.