



SPECIFICATION SHEET

| | | |
|---|---|--|
| SPECIFICATION SHEET NO. | Q1022-SMDJ28CA00SDFG | |
| DATE | Oct. 22, 2023 | |
| REVISION | A0 | Updated With Most Recent Data - Official First Release |
| DESCRIPTION AND MAIN PARAMETRICS | <p>SMD Transient Voltage Suppressor (TVs) Diodes, SMDJ series, SMDJ28CA Type, 2 Pads, Bidirectional , Reverse Stand-off Voltage (V R) 28V Peak Pulse Power: 3000 Watts. Operating Temp. Range -65°C ~+150°C Package in Tape/Reel, 3000pcs/Reel RoHS/RoHS III and REACH Compliant</p> | |
| CUSTOMER | | |
| CUSTOMER PART NO. | | |
| CROSS REF. PART NO. | | |
| ORIGINAL MFG/PART NO. | MDD/SMDJ28CA | |
| PART CODE | SMDJ28CA00SDFG | |

| |
|---|
| VENDOR APPROVE |
| Issued/Checked/Approved <div style="display: flex; justify-content: space-around; margin-top: 10px;">    </div> |
| DATE: Oct. 22, 2023 |

| |
|-------------------------|
| CUSTOMER APPROVE |
| |
| DATE: |

SMD TRANSIENT VOLTAGE SUPPRESSORS DIODES SMDJ SERIES

MAIN FEATURE

- Space Low Profile Package
- Built-in Strain Relief
- Glass Passivated Junction
- Low Inductance
- Excellent Clamping Capability
- 3000W Peak Pulse Power Capability At 10/1000µs Waveform,
- Repetition Rate (Duty Cycle): 0.01%
- Fast Response Time
- Typical Ir Less Than 1µa Above 10v
- High Temperature Soldering: 260°C/10 Seconds At Terminals
- Plastic Package Has Underwriters Laboratory Flammability 94V-0
- RoHS III Complaint
- Cross Main Competitor Parts in Market



APPLICATION

- I/O Interface
- AC/DC Power Supply
- Low Frequency Signal Transmission Line (RS232, RS485, etc.)

RFQ
Request For Quotation

PART CODE GUIDE

| SMDJ | 28CA00 | S | DFG |
|------|--------|---|-----|
| 1 | 2 | 3 | 4 |

1. SMDJ: SMD Transient Voltage Suppressor (TVs) Diodes, SMDJ series
2. 28CA00: Specification code for Bidirectional, Reverse Stand-off Voltage (V R) 28V
3. S: Package code, Tape/Reel
4. DFG: Marking code for “DFG” on the case surface, Different Marking for different specification

ELECTRICAL CHARACTERISTICS

See Page 5 ~ Page 10 For Different Part Code

HOW TO ORDER

Please indicate pat code and send us your RFQ by E-mail, sales@nextgencomponent.com

SMD TRANSIENT VOLTAGE SUPPRESSORS DIODES SMDJ SERIES

DIMENSION - Unit: Inch/mm

Image for reference



Marking: standard

* See Marking Code List page 5~10

Case Dimension:
SMC/DO-214AB

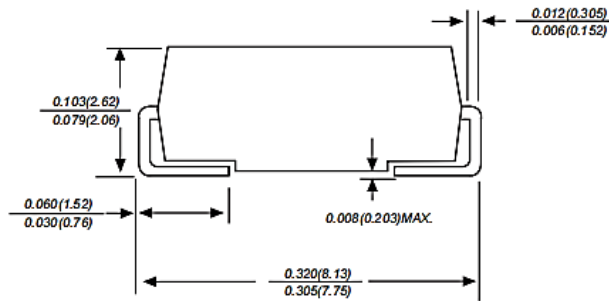
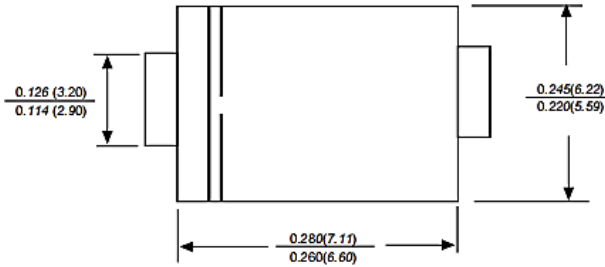

Recommend
Pad Layout

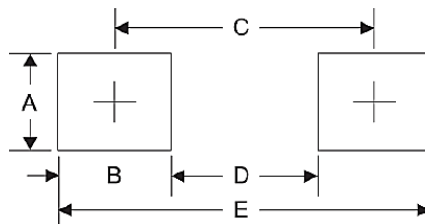

| Symbol | Unit (Inch) | Unit (mm) |
|--------|-------------|-----------|
| A | 0.170 | 4.3 |
| B | 0.160 | 4.1 |
| C | 0.311 | 7.9 |
| D | 0.150 | 3.8 |
| E | 0.472 | 12 |

SMD TRANSIENT VOLTAGE SUPPRESSORS DIODES SMDJ SERIES
MECHANICAL DATA

| Case | Terminals | Polarity | Mounting Position | Marking | Weight per piece |
|--|---|---------------------------------|-------------------|-----------------------|-------------------------|
| JEDEC SMC/DO-214AB molded plastic body | Solderable per MIL-STD-750, Method 2026 | Polarity symbol marking on body | ANY | See Marking Code List | 0.003 ounce, 0.095grams |

MAX. RATING & CHARACTERISTICS - Ratings at 25°C Ambient Temperature Unless Otherwise Specified.

| Parameter | SYMBOLS | VALUE | UNITS |
|--|---------|------------|-------|
| Peak pulse power dissipation at 10/1000µs waveform (Note 1, Note 2) | P ppm | 3000 | W |
| Maximum Instantaneous Forward Voltage at 100A for Unidirectional only | V F | 3.5 | V |
| Steady state power dissipation at TA=50°C | P M(AV) | 6.5 | W |
| Peak forward surge current, 8.3ms single half sine-wave superimposed on rated load, (JEDEC Method) | I FSM | 300 | A |
| Typical thermal resistance junction to lead | R θJL | 15 | °C/W |
| Typical thermal resistance junction to ambient | R θJA | 75 | °C/W |
| Operating junction temperature range | T J | -65 ~ +150 | °C |
| Storage temperature range | T stg | -65 ~ +150 | °C |

Notes

1. Non-repetitive current pulse, per Fig 3 and derated above TA=25 °C per Fig 2
2. Measured on 8.3ms single half sine wave or equivalent square wave for unidirectional device only, duty cycle=4 per minute maximum.

SMD TRANSIENT VOLTAGE SUPPRESSORS DIODES SMDJ SERIES
ELECTRICAL CHARACTERISTICS UNIDIRECTIONAL TYPE - Ta = 25°C

| Part Code | Reverse Stand-off Voltage V R (V) | Breakdown Voltage V BR @ I T (V) | | Test Current I T (mA) | Max. Clamp Voltage V C @ I PP (V) | Peak Pulse Current I PP (A) | Reverse Leakage I R @ V R (μA) | Marking Code |
|----------------|-----------------------------------|----------------------------------|-------|-----------------------|-----------------------------------|-----------------------------|--------------------------------|--------------|
| | | Min. | Max. | | | | | |
| SMDJ050A00SRDE | 5.0 | 6.40 | 7.00 | 10 | 9.2 | 326.1 | 800 | RDE |
| SMDJ060A00SRDG | 6.0 | 6.67 | 7.37 | 10 | 10.3 | 291.3 | 800 | RDG |
| SMDJ065A00SRDK | 6.5 | 7.22 | 7.98 | 10 | 11.2 | 267.9 | 500 | RDK |
| SMDJ070A00SPDM | 7.0 | 7.78 | 8.60 | 10 | 12.0 | 250.0 | 200 | PDM |
| SMDJ075A00SPDP | 7.5 | 8.33 | 9.21 | 1 | 12.9 | 232.6 | 100 | PDP |
| SMDJ080A00SPDR | 8.0 | 8.89 | 9.83 | 1 | 13.6 | 220.6 | 50 | PDR |
| SMDJ085A00SPDT | 8.5 | 9.44 | 10.40 | 1 | 14.4 | 208.3 | 20 | PDT |
| SMDJ090A00SPDV | 9.0 | 10.00 | 11.10 | 1 | 15.4 | 194.8 | 10 | PDV |
| SMDJ10A000SPDX | 10.0 | 11.10 | 12.30 | 1 | 17.0 | 176.5 | 5 | PDX |
| SMDJ11A000SPDZ | 11.0 | 12.20 | 13.50 | 1 | 18.2 | 164.8 | 2 | PDZ |
| SMDJ12A000SPEE | 12.0 | 13.30 | 14.70 | 1 | 19.9 | 150.8 | 2 | PEE |
| SMDJ13A000SPEG | 13.0 | 14.40 | 15.90 | 1 | 21.5 | 139.5 | 2 | PEG |
| SMDJ14A000SPEK | 14.0 | 15.60 | 17.20 | 1 | 23.2 | 129.3 | 2 | PEK |
| SMDJ15A000SPEM | 15.0 | 16.70 | 18.50 | 1 | 24.4 | 123.0 | 2 | PEM |
| SMDJ16A000SPEP | 16.0 | 17.80 | 19.70 | 1 | 26.0 | 115.4 | 2 | PEP |
| SMDJ17A000SPER | 17.0 | 18.90 | 20.90 | 1 | 27.6 | 108.7 | 2 | PER |
| SMDJ18A000SPET | 18.0 | 20.00 | 22.10 | 1 | 29.2 | 102.7 | 2 | PET |
| SMDJ20A000SPEV | 20.0 | 22.20 | 24.50 | 1 | 32.4 | 92.6 | 2 | PEV |
| SMDJ22A000SPEX | 22.0 | 24.40 | 26.90 | 1 | 35.5 | 84.5 | 2 | PEX |
| SMDJ24A000SPEZ | 24.0 | 26.70 | 29.50 | 1 | 38.9 | 77.1 | 2 | PEZ |

SMD TRANSIENT VOLTAGE SUPPRESSORS DIODES SMDJ SERIES
ELECTRICAL CHARACTERISTICS UNIDIRECTIONAL TYPE - Ta = 25°C

| Part Code | Reverse Stand-off Voltage V _R (V) | Breakdown Voltage V _{BR} @ I _T (V) | | Test Current I _T (mA) | Max. Clamp Voltage V _C @ I _{PP} (V) | Peak Pulse Current I _{PP} (A) | Reverse Leakage I _R @ V _R (μA) | Marking Code |
|----------------|--|--|--------|----------------------------------|---|--|--|--------------|
| | | Min. | Max. | | | | | |
| SMDJ26A000SPFE | 26.0 | 28.90 | 31.90 | 1 | 42.1 | 71.3 | 2 | PFE |
| SMDJ28A000SPFG | 28.0 | 31.10 | 34.40 | 1 | 45.4 | 66.1 | 2 | PFG |
| SMDJ30A000SPFK | 30.0 | 33.30 | 36.80 | 1 | 48.4 | 62.0 | 2 | PFK |
| SMDJ33A000SPFM | 33.0 | 36.70 | 40.60 | 1 | 53.3 | 56.3 | 2 | PFM |
| SMDJ36A000SPFP | 36.0 | 40.00 | 44.20 | 1 | 58.1 | 51.6 | 2 | PFP |
| SMDJ40A000SPFR | 40.0 | 44.40 | 49.10 | 1 | 64.5 | 46.5 | 2 | PFR |
| SMDJ43A000SPFT | 43.0 | 47.80 | 52.80 | 1 | 69.4 | 43.2 | 2 | PFT |
| SMDJ45A000SPFV | 45.0 | 50.00 | 55.30 | 1 | 72.7 | 41.3 | 2 | PFV |
| SMDJ48A000SPFX | 48.0 | 53.30 | 58.90 | 1 | 77.4 | 38.8 | 2 | PFX |
| SMDJ51A000SPFZ | 51.0 | 56.70 | 62.70 | 1 | 82.4 | 36.4 | 2 | PFZ |
| SMDJ54A000SRGE | 54.0 | 60.00 | 66.30 | 1 | 87.1 | 34.4 | 2 | RGE |
| SMDJ58A000SPGG | 58.0 | 64.40 | 71.20 | 1 | 93.6 | 32.1 | 2 | PGG |
| SMDJ60A000SPGK | 60.0 | 66.70 | 73.70 | 1 | 96.8 | 31.0 | 2 | PGK |
| SMDJ64A000SPGM | 64.0 | 71.10 | 78.60 | 1 | 103.0 | 29.1 | 2 | PGM |
| SMDJ70A000SPGP | 70.0 | 77.80 | 86.00 | 1 | 113.0 | 26.5 | 2 | PGP |
| SMDJ75A000SPGR | 75.0 | 83.30 | 92.10 | 1 | 121.0 | 24.8 | 2 | PGR |
| SMDJ78A000SPGT | 78.0 | 86.70 | 95.80 | 1 | 126.0 | 23.8 | 2 | PGT |
| SMDJ85A000SPGV | 85.0 | 94.40 | 104.00 | 1 | 137.0 | 21.9 | 2 | PGV |
| SMDJ90A000SPGX | 90.0 | 100.00 | 111.00 | 1 | 146.0 | 20.5 | 2 | PGX |
| SMDJ100A00SPGZ | 100.0 | 111.00 | 123.00 | 1 | 162.0 | 18.5 | 2 | PGZ |

SMD TRANSIENT VOLTAGE SUPPRESSORS DIODES SMDJ SERIES
ELECTRICAL CHARACTERISTICS UNIDIRECTIONAL TYPE - Ta = 25°C

| Part Code | Reverse Stand-off Voltage V _R (V) | Breakdown Voltage V _{BR} @ I _T (V) | | Test Current I _T (mA) | Max. Clamp Voltage V _C @ I _{PP} (V) | Peak Pulse Current I _{PP} (A) | Reverse Leakage I _R @ V _R (μA) | Marking Code |
|----------------|--|--|--------|----------------------------------|---|--|--|--------------|
| | | Min. | Max. | | | | | |
| SMDJ110A00SPHE | 110.0 | 122.00 | 135.00 | 1 | 177.0 | 16.9 | 2 | PHE |
| SMDJ120A00SPHG | 120.0 | 133.00 | 147.00 | 1 | 193.0 | 15.5 | 2 | PHG |
| SMDJ130A00SPHK | 130.0 | 144.00 | 159.00 | 1 | 209.0 | 14.4 | 2 | PHK |
| SMDJ150A00SPHM | 150.0 | 167.00 | 185.00 | 1 | 243.0 | 12.3 | 2 | PHM |
| SMDJ160A00SPHP | 160.0 | 178.00 | 197.00 | 1 | 259.0 | 11.6 | 2 | PHP |
| SMDJ170A00SPHR | 170.0 | 189.00 | 209.00 | 1 | 275.0 | 10.9 | 2 | PHR |

Note:

1. For parts without A, the V_{BR} is ± 10%, and V_C is 5% higher than A parts.
2. For bidirectional type having V_R of 10 volts and less, the I_R limit is double.

SMD TRANSIENT VOLTAGE SUPPRESSORS DIODES SMDJ SERIES
ELECTRICAL CHARACTERISTICS BIDIRECTIONAL TYPE - Ta = 25°C

| Part Code | Reverse Stand-off Voltage V _R (V) | Breakdown Voltage V _{BR} @ I _T (V) | | Test Current I _T (mA) | Max. Clamp Voltage V _C @ I _{PP} (V) | Peak Pulse Current I _{PP} (A) | Reverse Leakage I _R @ V _R (μA) | Marking Code |
|----------------|--|--|-------|----------------------------------|---|--|--|--------------|
| | | Min. | Max. | | | | | |
| SMDJ050CA0SDDE | 5.0 | 6.40 | 7.00 | 10 | 9.2 | 326.1 | 800 | DDE |
| SMDJ060CA0SDDG | 6.0 | 6.67 | 7.37 | 10 | 10.3 | 291.3 | 800 | DDG |
| SMDJ065CA0SDDK | 6.5 | 7.22 | 7.98 | 10 | 11.2 | 267.9 | 500 | DDK |
| SMDJ070CA0SDDM | 7.0 | 7.78 | 8.60 | 10 | 12.0 | 250.0 | 200 | DDM |
| SMDJ075CA0SDDP | 7.5 | 8.33 | 9.21 | 1 | 12.9 | 232.6 | 100 | DDP |
| SMDJ080CA0SDDR | 8.0 | 8.89 | 9.83 | 1 | 13.6 | 220.6 | 50 | DDR |
| SMDJ085CA0SDDT | 8.5 | 9.44 | 10.40 | 1 | 14.4 | 208.3 | 20 | DDT |
| SMDJ090CA0SDDV | 9.0 | 10.00 | 11.10 | 1 | 15.4 | 194.8 | 10 | DDV |
| SMDJ10CA00SDDX | 10.0 | 11.10 | 12.30 | 1 | 17.0 | 176.5 | 5 | DDX |
| SMDJ11CA00SDDZ | 11.0 | 12.20 | 13.50 | 1 | 18.2 | 164.8 | 2 | DDZ |
| SMDJ12CA00SDEE | 12.0 | 13.30 | 14.70 | 1 | 19.9 | 150.8 | 2 | DEE |
| SMDJ13CA00SDEG | 13.0 | 14.40 | 15.90 | 1 | 21.5 | 139.5 | 2 | DEG |
| SMDJ14CA00SDEK | 14.0 | 15.60 | 17.20 | 1 | 23.2 | 129.3 | 2 | DEK |
| SMDJ15CA00SDEM | 15.0 | 16.70 | 18.50 | 1 | 24.4 | 123.0 | 2 | DEM |
| SMDJ16CA00SDEP | 16.0 | 17.80 | 19.70 | 1 | 26.0 | 115.4 | 2 | DEP |
| SMDJ17CA00SDER | 17.0 | 18.90 | 20.90 | 1 | 27.6 | 108.7 | 2 | DER |
| SMDJ18CA00SDET | 18.0 | 20.00 | 22.10 | 1 | 29.2 | 102.7 | 2 | DET |
| SMDJ20CA00SDEV | 20.0 | 22.20 | 24.50 | 1 | 32.4 | 92.6 | 2 | DEV |
| SMDJ22CA00SDEX | 22.0 | 24.40 | 26.90 | 1 | 35.5 | 84.5 | 2 | DEX |
| SMDJ24CA00SDEZ | 24.0 | 26.70 | 29.50 | 1 | 38.9 | 77.1 | 2 | DEZ |

SMD TRANSIENT VOLTAGE SUPPRESSORS DIODES SMDJ SERIES
ELECTRICAL CHARACTERISTICS BIDIRECTIONAL TYPE - Ta = 25°C

| Part Code | Reverse Stand-off Voltage V _R (V) | Breakdown Voltage V _{BR} @ I _T (V) | | Test Current I _T (mA) | Max. Clamp Voltage V _C @ I _{PP} (V) | Peak Pulse Current I _{PP} (A) | Reverse Leakage I _R @ V _R (μA) | Marking Code |
|-----------------------|--|--|--------------|----------------------------------|---|--|--|--------------|
| | | Min. | Max. | | | | | |
| SMDJ26CA00SDFE | 26.0 | 28.90 | 31.90 | 1 | 42.1 | 71.3 | 2 | DFE |
| SMDJ28CA00SDFG | 28.0 | 31.10 | 34.40 | 1 | 45.4 | 66.1 | 2 | DFG |
| SMDJ30CA00SDFK | 30.0 | 33.30 | 36.80 | 1 | 48.4 | 62.0 | 2 | DFK |
| SMDJ33CA00SDFM | 33.0 | 36.70 | 40.60 | 1 | 53.3 | 56.3 | 2 | DFM |
| SMDJ36CA00SDFP | 36.0 | 40.00 | 44.20 | 1 | 58.1 | 51.6 | 2 | DFP |
| SMDJ40CA00SDFR | 40.0 | 44.40 | 49.10 | 1 | 64.5 | 46.5 | 2 | DFR |
| SMDJ43CA00SDFT | 43.0 | 47.80 | 52.80 | 1 | 69.4 | 43.2 | 2 | DFT |
| SMDJ45CA00SDFV | 45.0 | 50.00 | 55.30 | 1 | 72.7 | 41.3 | 2 | DFV |
| SMDJ48CA00SDFX | 48.0 | 53.30 | 58.90 | 1 | 77.4 | 38.8 | 2 | DFX |
| SMDJ51CA00SDFZ | 51.0 | 56.70 | 62.70 | 1 | 82.4 | 36.4 | 2 | DFZ |
| SMDJ54CA00SDGE | 54.0 | 60.00 | 66.30 | 1 | 87.1 | 34.4 | 2 | DGE |
| SMDJ58CA00SDGG | 58.0 | 64.40 | 71.20 | 1 | 93.6 | 32.1 | 2 | DGG |
| SMDJ60CA00SDGK | 60.0 | 66.70 | 73.70 | 1 | 96.8 | 31.0 | 2 | DGK |
| SMDJ64CA00SDGM | 64.0 | 71.10 | 78.60 | 1 | 103.0 | 29.1 | 2 | DGM |
| SMDJ70CA00SDGP | 70.0 | 77.80 | 86.00 | 1 | 113.0 | 26.5 | 2 | DGP |
| SMDJ75CA00SDGR | 75.0 | 83.30 | 92.10 | 1 | 121.0 | 24.8 | 2 | DGR |
| SMDJ78CA00SDGT | 78.0 | 86.70 | 95.80 | 1 | 126.0 | 23.8 | 2 | DGT |
| SMDJ85CA00SDGV | 85.0 | 94.40 | 104.00 | 1 | 137.0 | 21.9 | 2 | DGV |
| SMDJ90CA00SDGX | 90.0 | 100.00 | 111.00 | 1 | 146.0 | 20.5 | 2 | DGX |
| SMDJ100CA00SDGZ | 100.0 | 111.00 | 123.00 | 1 | 162.0 | 18.5 | 2 | DGZ |

SMD TRANSIENT VOLTAGE SUPPRESSORS DIODES SMDJ SERIES

ELECTRICAL CHARACTERISTICS BIDIRECTIONAL TYPE - Ta = 25°C

| Part Code | Reverse Stand-off Voltage V _R (V) | Breakdown Voltage V _{BR} @ I _T (V) | | Test Current I _T (mA) | Max. Clamp Voltage V _C @ I _{PP} (V) | Peak Pulse Current I _{PP} (A) | Reverse Leakage I _R @ V _R (μA) | Marking Code |
|----------------|--|--|--------|----------------------------------|---|--|--|--------------|
| | | Min. | Max. | | | | | |
| SMDJ110CA0SDHE | 110.0 | 122.00 | 135.00 | 1 | 177.0 | 16.9 | 2 | DHE |
| SMDJ120CA0SDHG | 120.0 | 133.00 | 147.00 | 1 | 193.0 | 15.5 | 2 | DHG |
| SMDJ130CA0SDHK | 130.0 | 144.00 | 159.00 | 1 | 209.0 | 14.4 | 2 | DHK |
| SMDJ150CA0SDHM | 150.0 | 167.00 | 185.00 | 1 | 243.0 | 12.3 | 2 | DHM |
| SMDJ160CA0SDHP | 160.0 | 178.00 | 197.00 | 1 | 259.0 | 11.6 | 2 | DHP |
| SMDJ170CA0SDHR | 170.0 | 189.00 | 209.00 | 1 | 275.0 | 10.9 | 2 | DHR |

Note:

1. For parts without A , the VBR is ± 10%, and VC is 5% higher than A parts.
2. For bidirectional type having VR of 10 volts and less, the IR limit is double.

SMD TRANSIENT VOLTAGE SUPPRESSORS DIODES SMDJ SERIES
RELIABILITY

| Number | Experiment Items | Experiment Method And Conditions | Reference Documents |
|--------|------------------------------------|--|---------------------------------|
| 1 | Solder Resistance Test | Test 260°C± 5°C for 10 ± 2 sec. Immerse body into solder 1/16" ± 1/32" | MIL-STD-750D METHOD-2031.2 |
| 2 | Solderability Test | 230°C ±5°C for 5 sec. | MIL-STD-750D METHOD-2026.1 0 |
| 3 | Pull Test | 1 kg in axial lead direction for 10 sec. | MIL-STD-750D METHOD-2036.4 |
| 4 | Bend Test | 0.5Kg Weight Applied To Each Lead, Bending Arcs 90 °C ± 5 °C For 3 Times | MIL-STD-750D METHOD-2036.4 |
| 5 | High Temperature Reverse Bias Test | TA=100°C for 1000 Hours at VR=80% Rated VR | MIL-STD-750D METHOD-1038.4 |
| 6 | Forward Operation Life Test | TA=25°C Rated Average Rectified Current | MIL-STD-750D METHOD-1027.3 |
| 7 | Intermittent Operation Life Test | On state: 5 min with rated IRMS Power Off state: 5 min with Cool Forced Air. On and off for 1000 cycles. | MIL-STD-750D METHOD-1036.3 |
| 8 | Pressure Cooker Test | 15 PSIG, TA=121°C, 4 hours | MIL-S-19500 APPENOIXC |
| 9 | Temperature Cycling Test | -55°C~+125°C; 30 Minutes For Dwelled Time 5 minutes for transferred time. Total: 10 cycles. | MIL-STD-750D METHOD-1051.7 |
| 10 | Thermal Shock Test | 0°C for 5 minutes., 100°C for 5minutes, Total: 10 cycles | MIL-STD-750D METHOD-1056.7 |
| 11 | Forward Surge Test | 8.3ms Single Sale Sine-wave One Surge. | MIL-STD-750D METHOD-4066.4 |
| 12 | Humidity Test | TA=65°C, RH=98% for 1000 hours. | MIL-STD-750D METHOD-1021.3 |
| 13 | High Temperature Storage life Test | 150°C for 1000 Hours | MIL-STD-750D METHOD-1031.5 |

SMD TRANSIENT VOLTAGE SUPPRESSORS DIODES SMDJ SERIES

SUGGESTED REFLOW PROFILE - For Reference Only



| | | |
|--|----------------------------------|-------------------|
| Profile Feature | | Pb-Free Assembly |
| Average Ramp-up Rate (Ts Max to Tp) | | 3°C/second Max |
| Preheat | Temperature Min (Ts Min.) | 150°C |
| | Temperature Max (Ts Max.) | 200°C |
| | Time (ts Min. to ts Max.) | 60 ~ 180 seconds |
| Time maintained above | Temperature (Tl) | 217°C |
| | Time (tL) | 60 ~ 150 seconds |
| Peak/Classification Temperature (Tp) | | 260 °C |
| Time within 5°C of actual Peak Temperature (tp) | | 20 ~ 40 seconds |
| Ramp-down rate | | 6 °C /Second Max. |
| Time 25 °C to Peak Temperature | | 8 minutes Max. |
| Suggest reflow times | | 3 Times Max. |

SMD TRANSIENT VOLTAGE SUPPRESSORS DIODES SMDJ SERIES

RATINGS AND CHARACTERISTIC CURVES (For Reference Only) - $T_a = 25^\circ\text{C}$ Unless Otherwise Specified

Figure 1. Peak Pulse Power Rating Curve

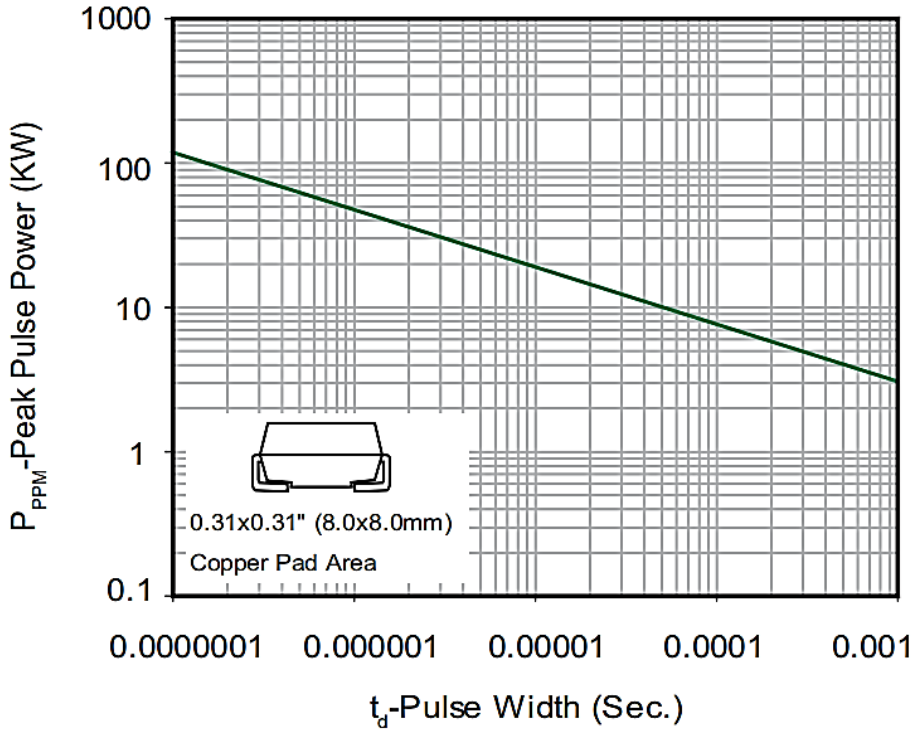
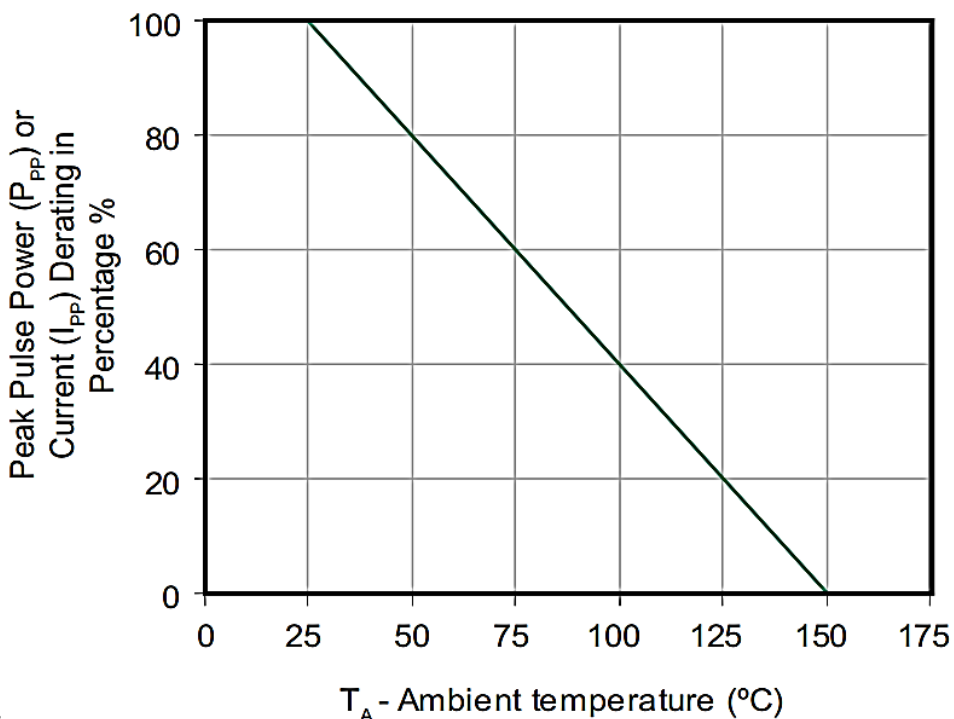

Figure 2. Pulse Derating Curve



SMD TRANSIENT VOLTAGE SUPPRESSORS DIODES SMDJ SERIES

RATINGS AND CHARACTERISTIC CURVES (For Reference Only) - $T_a = 25^\circ\text{C}$ Unless Otherwise Specified

Figure 3. Pulse Waveform

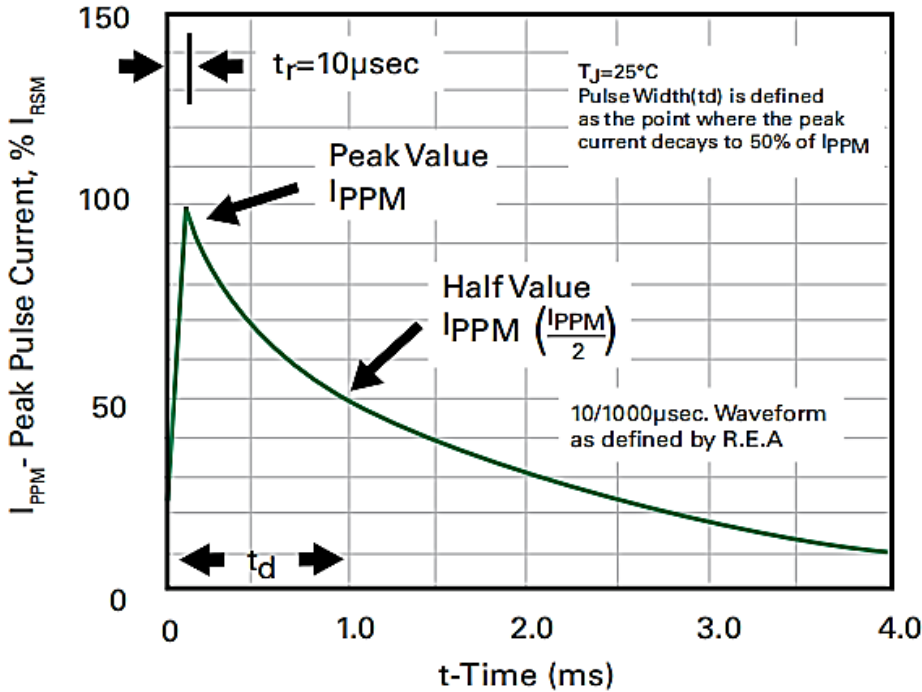
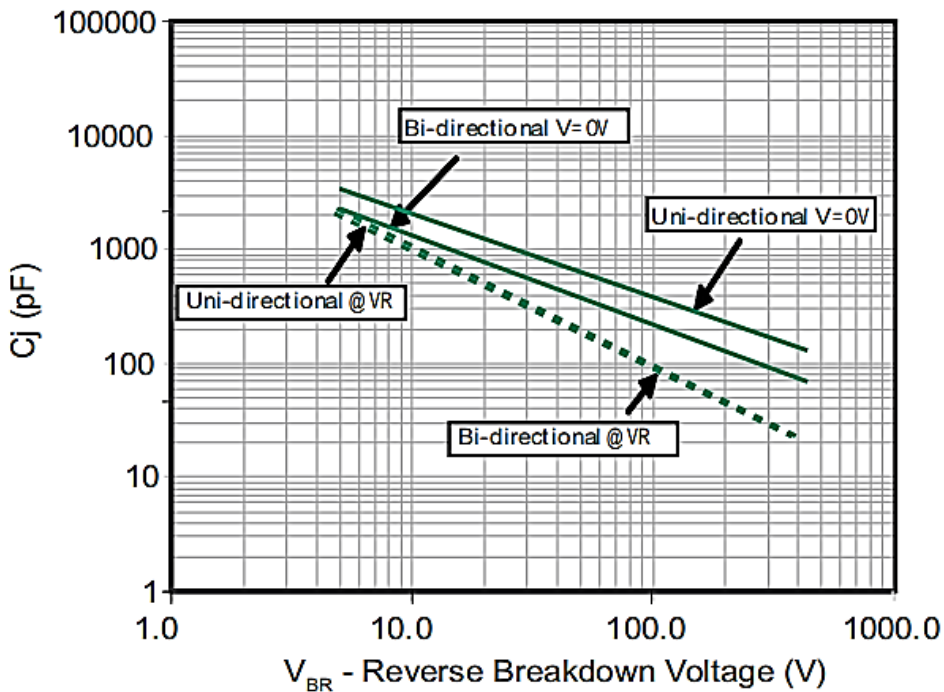

Figure 4 - Typical Junction Capacitance



SMD TRANSIENT VOLTAGE SUPPRESSORS DIODES SMDJ SERIES

RATINGS AND CHARACTERISTIC CURVES (For Reference Only) - $T_a = 25^\circ\text{C}$ Unless Otherwise Specified

Figure 5 - Steady State Power Derating Curve

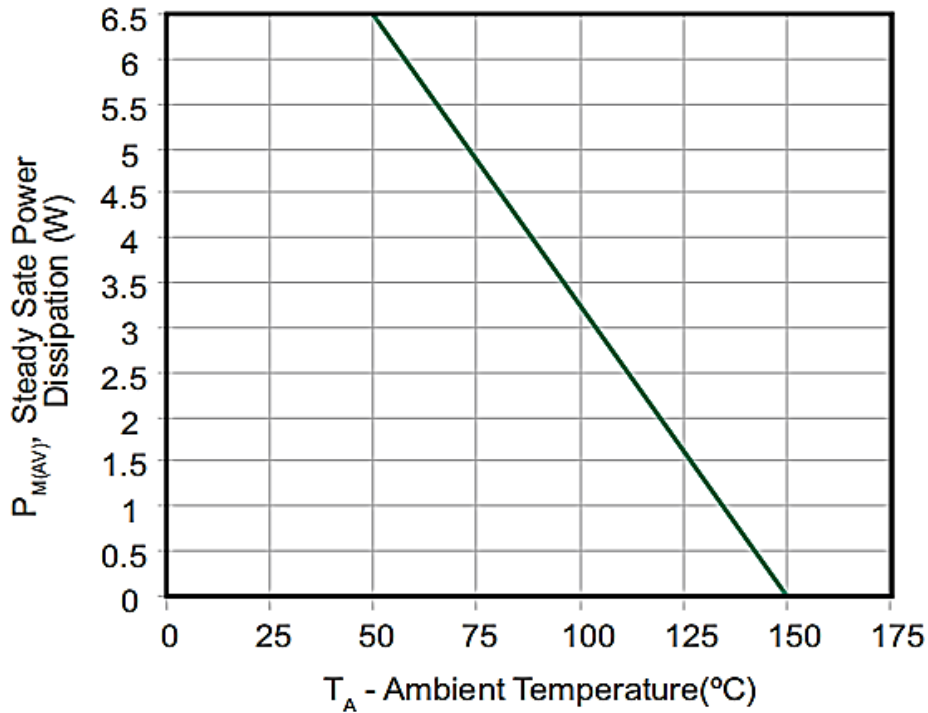
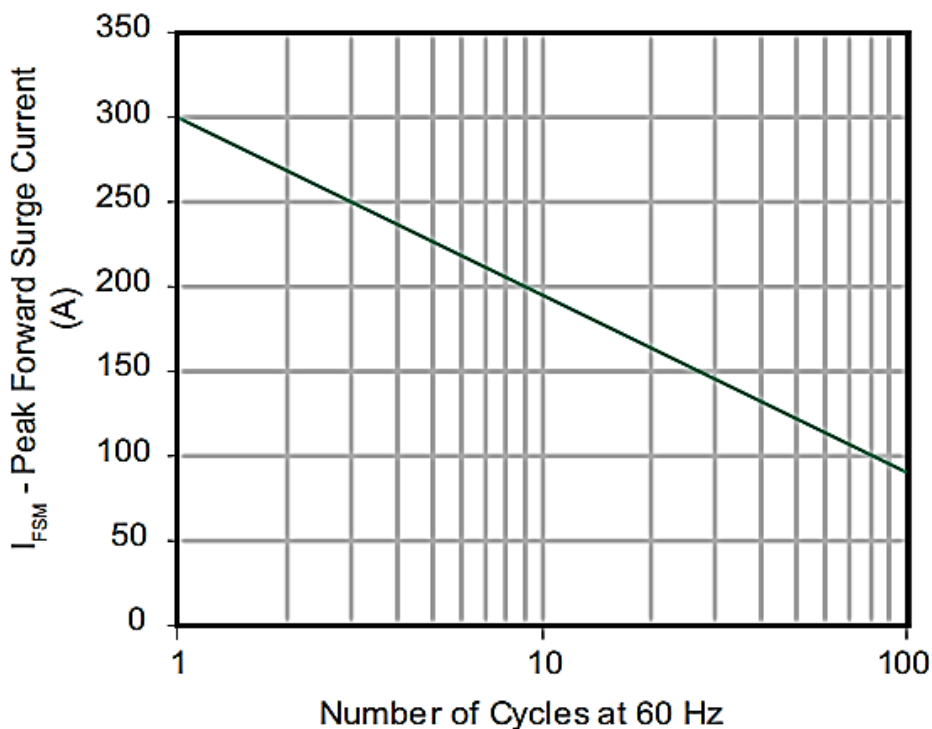

Figure 6 - Maximum Non-Repetitive Peak Forward Surge Current Uni-Directional only



SMD TRANSIENT VOLTAGE SUPPRESSORS DIODES SMDJ SERIES

RATINGS AND CHARACTERISTIC CURVES (For Reference Only) - $T_a = 25^\circ\text{C}$ Unless Otherwise Specified

Figure 7 - Steady State Power Derating
Dissipation Derating Curve

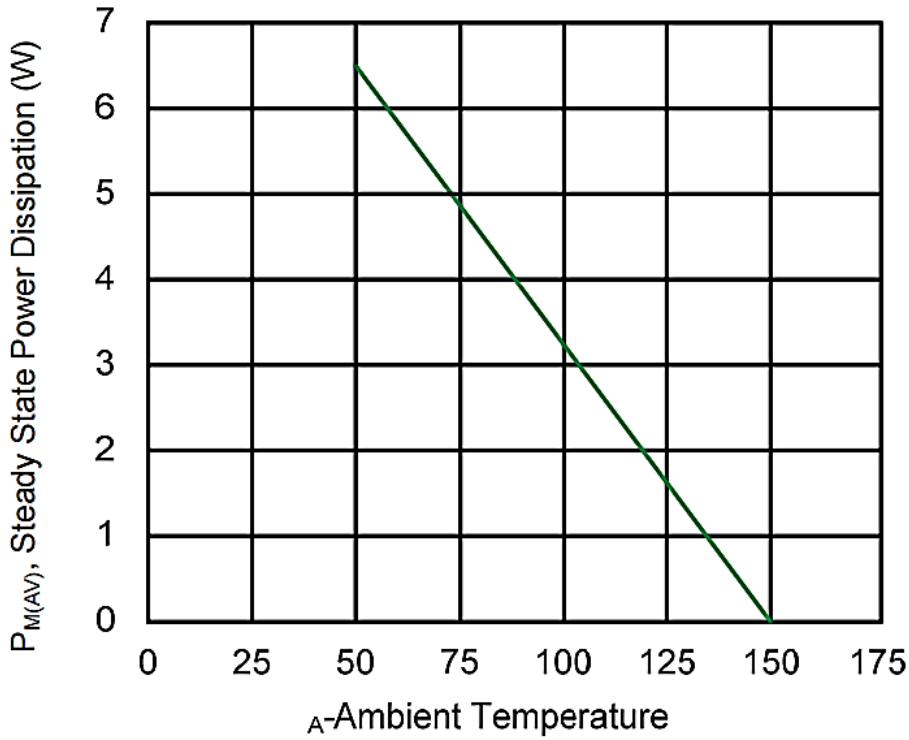
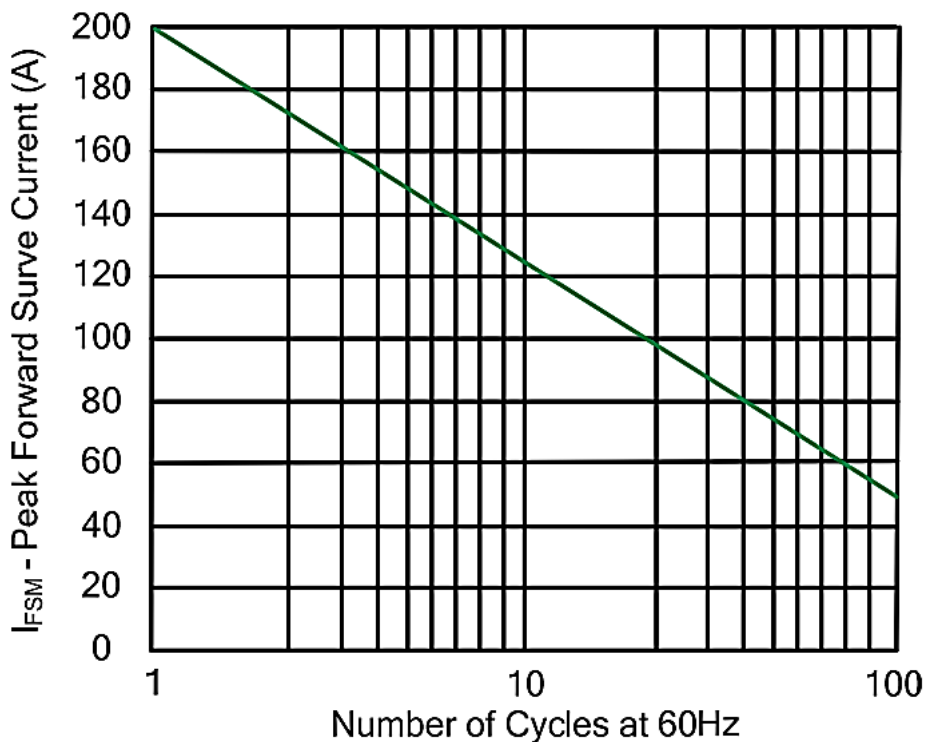
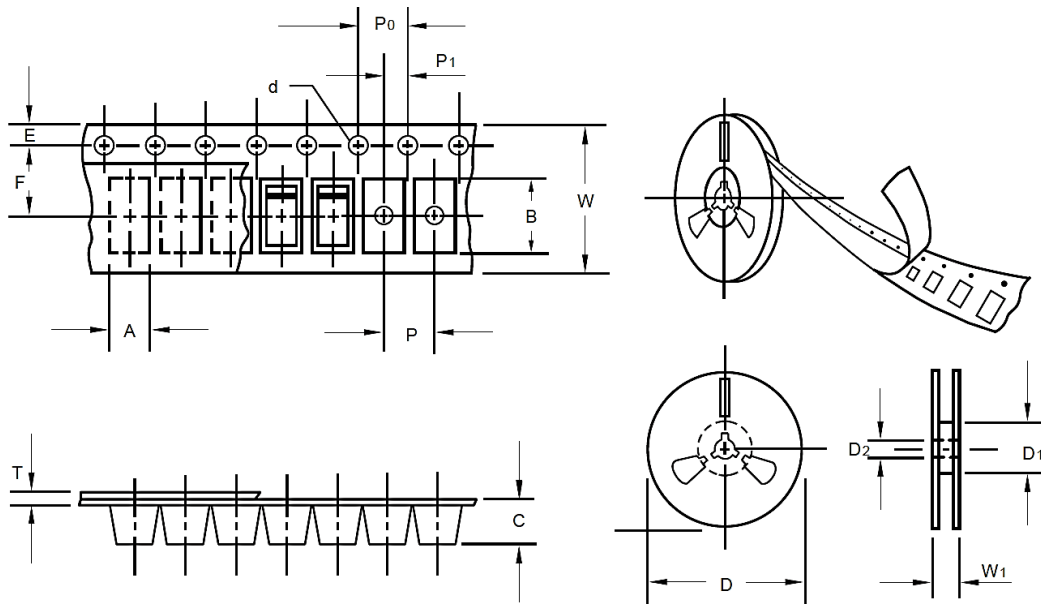

Figure 8 - Maximum Non-Repetitive Forward
Surge Current Uni-Directional only



SMD TRANSIENT VOLTAGE SUPPRESSORS DIODES SMDJ SERIES
TAPE/REEL (Unit: mm)

All Devices are packed in accordance with EIA standard RS-481-A and specifications.



| Item | Symbol | Tolerance | SMC/DO-214AB |
|--------------------------|----------------------------|-----------|--------------|
| Carrier width | A | 0.1 | 6.15 |
| Carrier Length | B | 0.1 | 8.41 |
| Carrier Depth | C | 0.1 | 2.42 |
| Sprocket hole | d | 0.05 | 1.50 |
| 13"Reel outside diameter | D | 2.0 | 330.0 |
| 13"Reel inner diameter | D1 | - | 50.0Min. |
| 7"Reel outside diameter | D | - | - |
| 7"Reel inner diameter | D1 | - | - |
| Feed hole diameter | D2 | 0.5 | 13.00 |
| Sprocket hole position | E | 0.1 | 1.75 |
| Punch hole position | F | 0.1 | 7.50 |
| Punch hole pitch | P | 0.1 | 8.00 |
| Sprocket hole pitch | P0 | 0.1 | 4.00 |
| Embossment center | P1 | 0.1 | 2.00 |
| Overall tape thickness | T | 0.1 | 0.25 |
| Tape width | W | 0.3 | 16.00 |
| Reel width | W1 | 1.0 | 16.50 |
| Package | 3000pcs/Reel, 2 Reels/ Box | | |

SMD TRANSIENT VOLTAGE SUPPRESSORS DIODES SMDJ SERIES

ROHS COMPLIANCE

- The levels of RoHS restricted materials in this product are below the maximum concentration values (also referred to as the threshold limits) permitted for such substances, or are used in an exempted application, in accordance with EU RoHS Directive (EU) 2015/863 EC (RoHS3). [RoHS Test Report](#) for this product can be obtained after clicked.

REACH COMPLIANCE

- REACH substances of high concern (SVHCs) information is available for this product. Since the European Chemical Agency (ECHA) has published notice of their intent to frequently revise the SVHC listing for the foreseeable future, [REACH Test Report](#) for this product can be obtained after clicked.

IMPORTANT NOTES AND DISCLAIMER

- 1) All Product parametric performance is indicated in the Electrical Characteristics for the listed herein test conditions, unless otherwise noted. Product performance may not be indicated by the Electrical Characteristics if operated under different conditions.
- 2) NextGen Component, Inc (*NextGen*) reserves the right to make changes to this document and its products and specifications at any time without notice. Customers should obtain and confirm the latest product information and specifications before final design, purchase or use.
- 3) *NextGen* makes no warranty, representation or guarantee regarding the suitability of its products for any particular purpose, nor does NextGen assume any liability for application assistance or customer product design.
- 4) *NextGen* does not warrant or accept any liability with products which are purchased or used for any unintended or unauthorized application. No license is granted by implication or otherwise under any intellectual property rights of NextGen.
- 5) *NextGen* products are not authorized for use as critical components in life support devices or systems without express written approval by *NextGen*.
- 6) *NextGen* requires that customers first obtain an RMA (Returned Merchandise Authorization) number prior to returning any products. Returns must be made within 30 days of the date of invoice, be in the original packaging, unused and like-new condition. At the time of quoting or purchasing, a product may say that it is Non-Cancelable/ Non-Returnable (NCNR). These products are not returnable and not refundable.