



SPECIFICATION SHEET

SPECIFICATION SHEET NO.	Q1022-SMDJ050A00SRDE	
DATE	Oct. 22, 2023	
REVISION	A0	Updated With Most Recent Data - Official First Release
DESCRIPTION AND MAIN PARAMETRICS	<p>SMD Transient Voltage Suppressor (TVS) Diodes, SMDJ series, SMDJ5.0A Type, 2 Pads, Unidirectional, Reverse Stand-off Voltage (V R) 5.0V Peak Pulse Power: 3000 Watts. Operating Temp. Range -65°C ~+150°C Package in Tape/Reel, 3000pcs/Reel RoHS/RoHS III and REACH Compliant</p>	
CUSTOMER		
CUSTOMER PART NO.		
CROSS REF. PART NO.		
ORIGINAL MFG/PART NO.	MDD/SMDJ5.0A	
PART CODE	SMDJ050A00SRDE	

VENDOR APPROVE			
Issued/Checked/Approved			
DATE: Oct. 22, 2023			

CUSTOMER APPROVE	
DATE:	

SMD TRANSIENT VOLTAGE SUPPRESSORS DIODES SMDJ SERIES

MAIN FEATURE

- Space Low Profile Package
- Built-in Strain Relief
- Glass Passivated Junction
- Low Inductance
- Excellent Clamping Capability
- 3000W Peak Pulse Power Capability At 10/1000µs Waveform,
- Repetition Rate (Duty Cycle): 0.01%
- Fast Response Time
- Typical Ir Less Than 1µa Above 10v
- High Temperature Soldering: 260°C/10 Seconds At Terminals
- Plastic Package Has Underwriters Laboratory Flammability 94V-0
- RoHS III Complaint
- Cross Main Competitor Parts in Market



APPLICATION

- I/O Interface
- AC/DC Power Supply
- Low Frequency Signal Transmission Line (RS232, RS485, etc.)

RFQ
Request For Quotation

PART CODE GUIDE

SMDJ	050A00	S	RDE
1	2	3	4

1. SMDJ: SMD Transient Voltage Suppressor (TVs) Diodes, SMDJ series
2. 050A00: Specification code for Unidirectional, Reverse Stand-off Voltage (V R) 5.0V
3. S: Package code, Tape/Reel
4. RDE: Marking code for “RDE” on the case surface, Different Marking for different specification

ELECTRICAL CHARACTERISTICS

See Page 5 ~ Page 10 For Different Part Code

HOW TO ORDER

Please indicate pat code and send us your RFQ by E-mail, sales@nextgencomponent.com

SMD TRANSIENT VOLTAGE SUPPRESSORS DIODES SMDJ SERIES

DIMENSION - Unit: Inch/mm

Image for reference



Marking: standard

* See Marking Code List page 5~10

Case Dimension:
SMC/DO-214AB

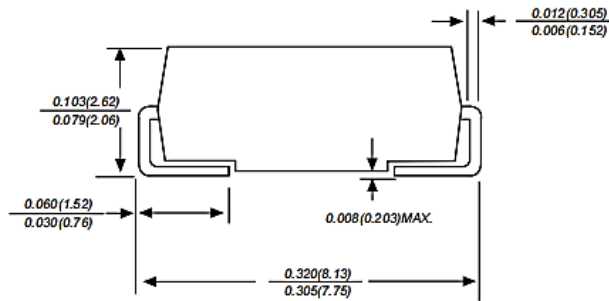
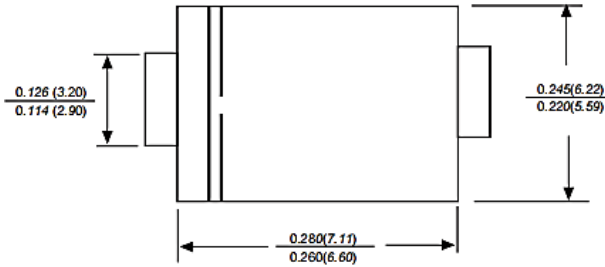

Recommend
Pad Layout

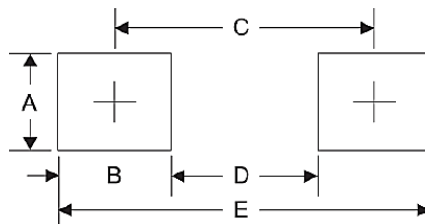

Symbol	Unit (Inch)	Unit (mm)
A	0.170	4.3
B	0.160	4.1
C	0.311	7.9
D	0.150	3.8
E	0.472	12

SMD TRANSIENT VOLTAGE SUPPRESSORS DIODES SMDJ SERIES
MECHANICAL DATA

Case	Terminals	Polarity	Mounting Position	Marking	Weight per piece
JEDEC SMC/DO-214AB molded plastic body	Solderable per MIL-STD-750, Method 2026	Polarity symbol marking on body	ANY	See Marking Code List	0.003 ounce, 0.095grams

MAX. RATING & CHARACTERISTICS - Ratings at 25°C Ambient Temperature Unless Otherwise Specified.

Parameter	SYMBOLS	VALUE	UNITS
Peak pulse power dissipation at 10/1000µs waveform (Note 1, Note 2)	P ppm	3000	W
Maximum Instantaneous Forward Voltage at 100A for Unidirectional only	V F	3.5	V
Steady state power dissipation at TA=50°C	P M(AV)	6.5	W
Peak forward surge current, 8.3ms single half sine-wave superimposed on rated load, (JEDEC Method)	I FSM	300	A
Typical thermal resistance junction to lead	R θJL	15	°C/W
Typical thermal resistance junction to ambient	R θJA	75	°C/W
Operating junction temperature range	T J	-65 ~ +150	°C
Storage temperature range	T stg	-65 ~ +150	°C

Notes

1. Non-repetitive current pulse, per Fig 3 and derated above TA=25 °C per Fig 2
2. Measured on 8.3ms single half sine wave or equivalent square wave for unidirectional device only, duty cycle=4 per minute maximum.

SMD TRANSIENT VOLTAGE SUPPRESSORS DIODES SMDJ SERIES
ELECTRICAL CHARACTERISTICS UNIDIRECTIONAL TYPE - Ta = 25°C

Part Code	Reverse Stand-off Voltage V _R (V)	Breakdown Voltage V _{BR} @ I _T (V)		Test Current I _T (mA)	Max. Clamp Voltage V _C @ I _{PP} (V)	Peak Pulse Current I _{PP} (A)	Reverse Leakage I _R @ V _R (μA)	Marking Code
		Min.	Max.					
SMDJ050A00SRDE	5.0	6.40	7.00	10	9.2	326.1	800	RDE
SMDJ060A00SRDG	6.0	6.67	7.37	10	10.3	291.3	800	RDG
SMDJ065A00SRDK	6.5	7.22	7.98	10	11.2	267.9	500	RDK
SMDJ070A00SPDM	7.0	7.78	8.60	10	12.0	250.0	200	PDM
SMDJ075A00SPDP	7.5	8.33	9.21	1	12.9	232.6	100	PDP
SMDJ080A00SPDR	8.0	8.89	9.83	1	13.6	220.6	50	PDR
SMDJ085A00SPDT	8.5	9.44	10.40	1	14.4	208.3	20	PDT
SMDJ090A00SPDV	9.0	10.00	11.10	1	15.4	194.8	10	PDV
SMDJ10A000SPDX	10.0	11.10	12.30	1	17.0	176.5	5	PDX
SMDJ11A000SPDZ	11.0	12.20	13.50	1	18.2	164.8	2	PDZ
SMDJ12A000SPEE	12.0	13.30	14.70	1	19.9	150.8	2	PEE
SMDJ13A000SPEG	13.0	14.40	15.90	1	21.5	139.5	2	PEG
SMDJ14A000SPEK	14.0	15.60	17.20	1	23.2	129.3	2	PEK
SMDJ15A000SPEM	15.0	16.70	18.50	1	24.4	123.0	2	PEM
SMDJ16A000SPEP	16.0	17.80	19.70	1	26.0	115.4	2	PEP
SMDJ17A000SPER	17.0	18.90	20.90	1	27.6	108.7	2	PER
SMDJ18A000SPET	18.0	20.00	22.10	1	29.2	102.7	2	PET
SMDJ20A000SPEV	20.0	22.20	24.50	1	32.4	92.6	2	PEV
SMDJ22A000SPEX	22.0	24.40	26.90	1	35.5	84.5	2	PEX
SMDJ24A000SPEZ	24.0	26.70	29.50	1	38.9	77.1	2	PEZ

SMD TRANSIENT VOLTAGE SUPPRESSORS DIODES SMDJ SERIES
ELECTRICAL CHARACTERISTICS UNIDIRECTIONAL TYPE - Ta = 25°C

Part Code	Reverse Stand-off Voltage V _R (V)	Breakdown Voltage V _{BR} @ I _T (V)		Test Current I _T (mA)	Max. Clamp Voltage V _C @ I _{PP} (V)	Peak Pulse Current I _{PP} (A)	Reverse Leakage I _R @ V _R (μA)	Marking Code
		Min.	Max.					
SMDJ26A000SPFE	26.0	28.90	31.90	1	42.1	71.3	2	PFE
SMDJ28A000SPFG	28.0	31.10	34.40	1	45.4	66.1	2	PFG
SMDJ30A000SPFK	30.0	33.30	36.80	1	48.4	62.0	2	PFK
SMDJ33A000SPFM	33.0	36.70	40.60	1	53.3	56.3	2	PFM
SMDJ36A000SPFP	36.0	40.00	44.20	1	58.1	51.6	2	PFP
SMDJ40A000SPFR	40.0	44.40	49.10	1	64.5	46.5	2	PFR
SMDJ43A000SPFT	43.0	47.80	52.80	1	69.4	43.2	2	PFT
SMDJ45A000SPFV	45.0	50.00	55.30	1	72.7	41.3	2	PFV
SMDJ48A000SPFX	48.0	53.30	58.90	1	77.4	38.8	2	PFX
SMDJ51A000SPFZ	51.0	56.70	62.70	1	82.4	36.4	2	PFZ
SMDJ54A000SRGE	54.0	60.00	66.30	1	87.1	34.4	2	RGE
SMDJ58A000SPGG	58.0	64.40	71.20	1	93.6	32.1	2	PGG
SMDJ60A000SPGK	60.0	66.70	73.70	1	96.8	31.0	2	PGK
SMDJ64A000SPGM	64.0	71.10	78.60	1	103.0	29.1	2	PGM
SMDJ70A000SPGP	70.0	77.80	86.00	1	113.0	26.5	2	PGP
SMDJ75A000SPGR	75.0	83.30	92.10	1	121.0	24.8	2	PGR
SMDJ78A000SPGT	78.0	86.70	95.80	1	126.0	23.8	2	PGT
SMDJ85A000SPGV	85.0	94.40	104.00	1	137.0	21.9	2	PGV
SMDJ90A000SPGX	90.0	100.00	111.00	1	146.0	20.5	2	PGX
SMDJ100A00SPGZ	100.0	111.00	123.00	1	162.0	18.5	2	PGZ

SMD TRANSIENT VOLTAGE SUPPRESSORS DIODES SMDJ SERIES

ELECTRICAL CHARACTERISTICS UNIDIRECTIONAL TYPE - Ta = 25°C

Part Code	Reverse Stand-off Voltage V _R (V)	Breakdown Voltage V _{BR} @ I _T (V)		Test Current I _T (mA)	Max. Clamp Voltage V _C @ I _{PP} (V)	Peak Pulse Current I _{PP} (A)	Reverse Leakage I _R @ V _R (μA)	Marking Code
		Min.	Max.					
SMDJ110A00SPHE	110.0	122.00	135.00	1	177.0	16.9	2	PHE
SMDJ120A00SPHG	120.0	133.00	147.00	1	193.0	15.5	2	PHG
SMDJ130A00SPHK	130.0	144.00	159.00	1	209.0	14.4	2	PHK
SMDJ150A00SPHM	150.0	167.00	185.00	1	243.0	12.3	2	PHM
SMDJ160A00SPHP	160.0	178.00	197.00	1	259.0	11.6	2	PHP
SMDJ170A00SPHR	170.0	189.00	209.00	1	275.0	10.9	2	PHR

Note:

1. For parts without A, the V_{BR} is ± 10%, and V_C is 5% higher than A parts.
2. For bidirectional type having V_R of 10 volts and less, the I_R limit is double.

SMD TRANSIENT VOLTAGE SUPPRESSORS DIODES SMDJ SERIES
ELECTRICAL CHARACTERISTICS BIDIRECTIONAL TYPE - Ta = 25°C

Part Code	Reverse Stand-off Voltage V _R (V)	Breakdown Voltage V _{BR} @ I _T (V)		Test Current I _T (mA)	Max. Clamp Voltage V _C @ I _{PP} (V)	Peak Pulse Current I _{PP} (A)	Reverse Leakage I _R @ V _R (μA)	Marking Code
		Min.	Max.					
SMDJ050CA0SDDE	5.0	6.40	7.00	10	9.2	326.1	800	DDE
SMDJ060CA0SDDG	6.0	6.67	7.37	10	10.3	291.3	800	DDG
SMDJ065CA0SDDK	6.5	7.22	7.98	10	11.2	267.9	500	DDK
SMDJ070CA0SDDM	7.0	7.78	8.60	10	12.0	250.0	200	DDM
SMDJ075CA0SDDP	7.5	8.33	9.21	1	12.9	232.6	100	DDP
SMDJ080CA0SDDR	8.0	8.89	9.83	1	13.6	220.6	50	DDR
SMDJ085CA0SDDT	8.5	9.44	10.40	1	14.4	208.3	20	DDT
SMDJ090CA0SDDV	9.0	10.00	11.10	1	15.4	194.8	10	DDV
SMDJ10CA00SDDX	10.0	11.10	12.30	1	17.0	176.5	5	DDX
SMDJ11CA00SDDZ	11.0	12.20	13.50	1	18.2	164.8	2	DDZ
SMDJ12CA00SDEE	12.0	13.30	14.70	1	19.9	150.8	2	DEE
SMDJ13CA00SDEG	13.0	14.40	15.90	1	21.5	139.5	2	DEG
SMDJ14CA00SDEK	14.0	15.60	17.20	1	23.2	129.3	2	DEK
SMDJ15CA00SDEM	15.0	16.70	18.50	1	24.4	123.0	2	DEM
SMDJ16CA00SDEP	16.0	17.80	19.70	1	26.0	115.4	2	DEP
SMDJ17CA00SDER	17.0	18.90	20.90	1	27.6	108.7	2	DER
SMDJ18CA00SDET	18.0	20.00	22.10	1	29.2	102.7	2	DET
SMDJ20CA00SDEV	20.0	22.20	24.50	1	32.4	92.6	2	DEV
SMDJ22CA00SDEX	22.0	24.40	26.90	1	35.5	84.5	2	DEX
SMDJ24CA00SDEZ	24.0	26.70	29.50	1	38.9	77.1	2	DEZ

SMD TRANSIENT VOLTAGE SUPPRESSORS DIODES SMDJ SERIES
ELECTRICAL CHARACTERISTICS BIDIRECTIONAL TYPE - Ta = 25°C

Part Code	Reverse Stand-off Voltage V _R (V)	Breakdown Voltage V _{BR @ I_T} (V)		Test Current I _T (mA)	Max. Clamp Voltage V _{C @ I_{PP}} (V)	Peak Pulse Current I _{PP} (A)	Reverse Leakage I _{R @ V_R} (μA)	Marking Code
		Min.	Max.					
SMDJ26CA00SDFE	26.0	28.90	31.90	1	42.1	71.3	2	DFE
SMDJ28CA00SDFG	28.0	31.10	34.40	1	45.4	66.1	2	DFG
SMDJ30CA00SDFK	30.0	33.30	36.80	1	48.4	62.0	2	DFK
SMDJ33CA00SDFM	33.0	36.70	40.60	1	53.3	56.3	2	DFM
SMDJ36CA00SDFP	36.0	40.00	44.20	1	58.1	51.6	2	DFP
SMDJ40CA00SDFR	40.0	44.40	49.10	1	64.5	46.5	2	DFR
SMDJ43CA00SDFT	43.0	47.80	52.80	1	69.4	43.2	2	DFT
SMDJ45CA00SDFV	45.0	50.00	55.30	1	72.7	41.3	2	DFV
SMDJ48CA00SDFX	48.0	53.30	58.90	1	77.4	38.8	2	DFX
SMDJ51CA00SDFZ	51.0	56.70	62.70	1	82.4	36.4	2	DFZ
SMDJ54CA00SDGE	54.0	60.00	66.30	1	87.1	34.4	2	DGE
SMDJ58CA00SDGG	58.0	64.40	71.20	1	93.6	32.1	2	DGG
SMDJ60CA00SDGK	60.0	66.70	73.70	1	96.8	31.0	2	DGK
SMDJ64CA00SDGM	64.0	71.10	78.60	1	103.0	29.1	2	DGM
SMDJ70CA00SDGP	70.0	77.80	86.00	1	113.0	26.5	2	DGP
SMDJ75CA00SDGR	75.0	83.30	92.10	1	121.0	24.8	2	DGR
SMDJ78CA00SDGT	78.0	86.70	95.80	1	126.0	23.8	2	DGT
SMDJ85CA00SDGV	85.0	94.40	104.00	1	137.0	21.9	2	DGV
SMDJ90CA00SDGX	90.0	100.00	111.00	1	146.0	20.5	2	DGX
SMDJ100CA0SDGZ	100.0	111.00	123.00	1	162.0	18.5	2	DGZ

SMD TRANSIENT VOLTAGE SUPPRESSORS DIODES SMDJ SERIES

ELECTRICAL CHARACTERISTICS BIDIRECTIONAL TYPE - Ta = 25°C

Part Code	Reverse Stand-off Voltage V _R (V)	Breakdown Voltage V _{BR} @ I _T (V)		Test Current I _T (mA)	Max. Clamp Voltage V _C @ I _{PP} (V)	Peak Pulse Current I _{PP} (A)	Reverse Leakage I _R @ V _R (μA)	Marking Code
		Min.	Max.					
SMDJ110CA0SDHE	110.0	122.00	135.00	1	177.0	16.9	2	DHE
SMDJ120CA0SDHG	120.0	133.00	147.00	1	193.0	15.5	2	DHG
SMDJ130CA0SDHK	130.0	144.00	159.00	1	209.0	14.4	2	DHK
SMDJ150CA0SDHM	150.0	167.00	185.00	1	243.0	12.3	2	DHM
SMDJ160CA0SDHP	160.0	178.00	197.00	1	259.0	11.6	2	DHP
SMDJ170CA0SDHR	170.0	189.00	209.00	1	275.0	10.9	2	DHR

Note:

1. For parts without A , the VBR is ± 10%, and VC is 5% higher than A parts.
2. For bidirectional type having VR of 10 volts and less, the IR limit is double.

SMD TRANSIENT VOLTAGE SUPPRESSORS DIODES SMDJ SERIES
RELIABILITY

Number	Experiment Items	Experiment Method And Conditions	Reference Documents
1	Solder Resistance Test	Test 260°C± 5°C for 10 ± 2 sec. Immerse body into solder 1/16" ± 1/32"	MIL-STD-750D METHOD-2031.2
2	Solderability Test	230°C ±5°C for 5 sec.	MIL-STD-750D METHOD-2026.1 0
3	Pull Test	1 kg in axial lead direction for 10 sec.	MIL-STD-750D METHOD-2036.4
4	Bend Test	0.5Kg Weight Applied To Each Lead, Bending Arcs 90 °C ± 5 °C For 3 Times	MIL-STD-750D METHOD-2036.4
5	High Temperature Reverse Bias Test	TA=100°C for 1000 Hours at VR=80% Rated VR	MIL-STD-750D METHOD-1038.4
6	Forward Operation Life Test	TA=25°C Rated Average Rectified Current	MIL-STD-750D METHOD-1027.3
7	Intermittent Operation Life Test	On state: 5 min with rated IRMS Power Off state: 5 min with Cool Forced Air. On and off for 1000 cycles.	MIL-STD-750D METHOD-1036.3
8	Pressure Cooker Test	15 PSIG, TA=121°C, 4 hours	MIL-S-19500 APPENOIXC
9	Temperature Cycling Test	-55°C~+125°C; 30 Minutes For Dwelled Time 5 minutes for transferred time. Total: 10 cycles.	MIL-STD-750D METHOD-1051.7
10	Thermal Shock Test	0°C for 5 minutes., 100°C for 5minutes, Total: 10 cycles	MIL-STD-750D METHOD-1056.7
11	Forward Surge Test	8.3ms Single Sale Sine-wave One Surge.	MIL-STD-750D METHOD-4066.4
12	Humidity Test	TA=65°C, RH=98% for 1000 hours.	MIL-STD-750D METHOD-1021.3
13	High Temperature Storage life Test	150°C for 1000 Hours	MIL-STD-750D METHOD-1031.5

SMD TRANSIENT VOLTAGE SUPPRESSORS DIODES SMDJ SERIES

SUGGESTED REFLOW PROFILE - For Reference Only

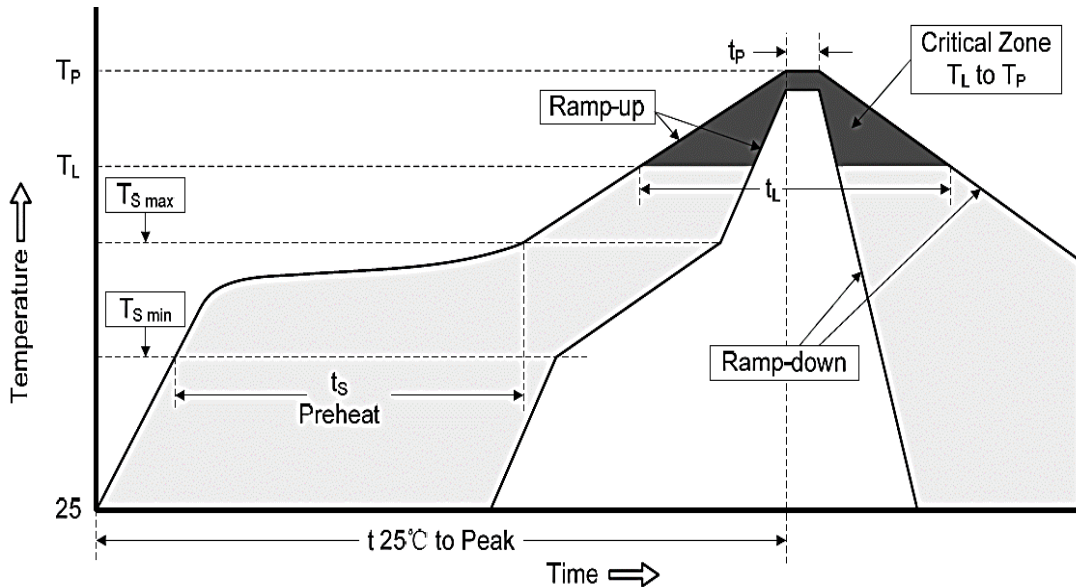

Profile Feature		Pb-Free Assembly
Average Ramp-up Rate (Ts Max to Tp)		3°C/second Max
Preheat	Temperature Min (Ts Min.)	150°C
	Temperature Max (Ts Max.)	200°C
	Time (ts Min. to ts Max.)	60 ~ 180 seconds
Time maintained above	Temperature (Tl)	217°C
	Time (tL)	60 ~ 150 seconds
Peak/Classification Temperature (Tp)		260 °C
Time within 5°C of actual Peak Temperature (tp)		20 ~ 40 seconds
Ramp-down rate		6 °C /Second Max.
Time 25 °C to Peak Temperature		8 minutes Max.
Suggest reflow times		3 Times Max.

SMD TRANSIENT VOLTAGE SUPPRESSORS DIODES SMDJ SERIES

RATINGS AND CHARACTERISTIC CURVES (For Reference Only) - $T_a = 25^\circ\text{C}$ Unless Otherwise Specified

Figure 1. Peak Pulse Power Rating Curve

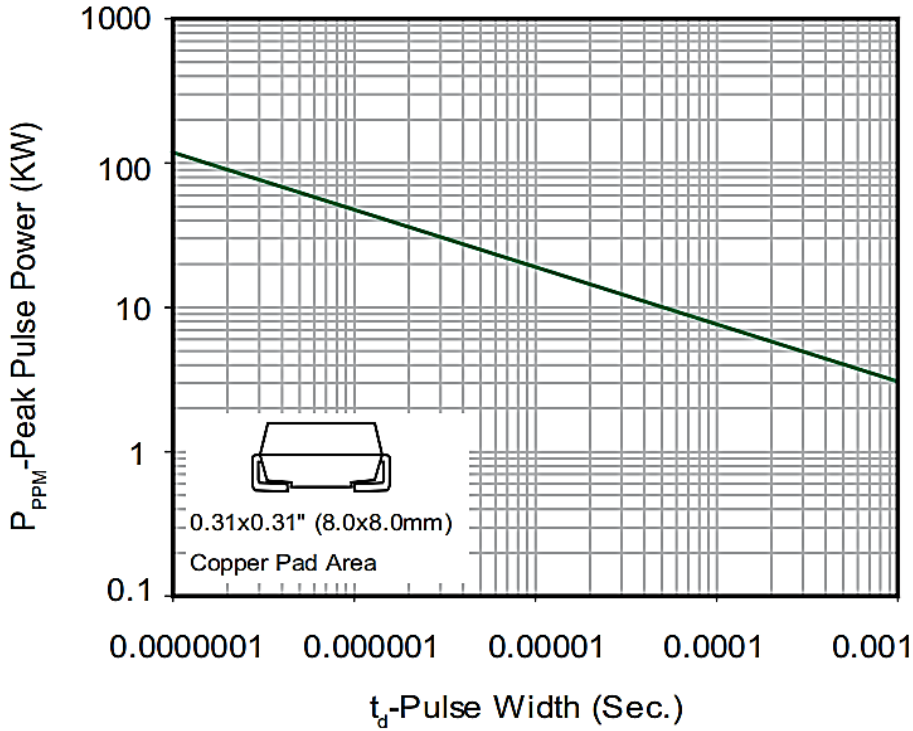
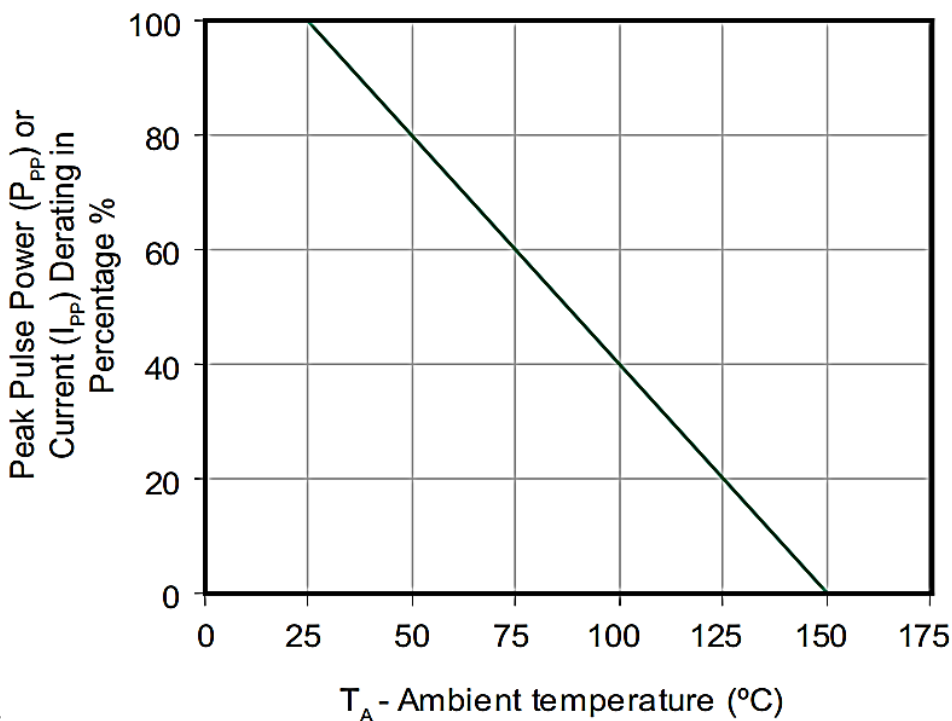

Figure 2. Pulse Derating Curve



SMD TRANSIENT VOLTAGE SUPPRESSORS DIODES SMDJ SERIES

RATINGS AND CHARACTERISTIC CURVES (For Reference Only) - $T_a = 25^\circ\text{C}$ Unless Otherwise Specified

Figure 3. Pulse Waveform

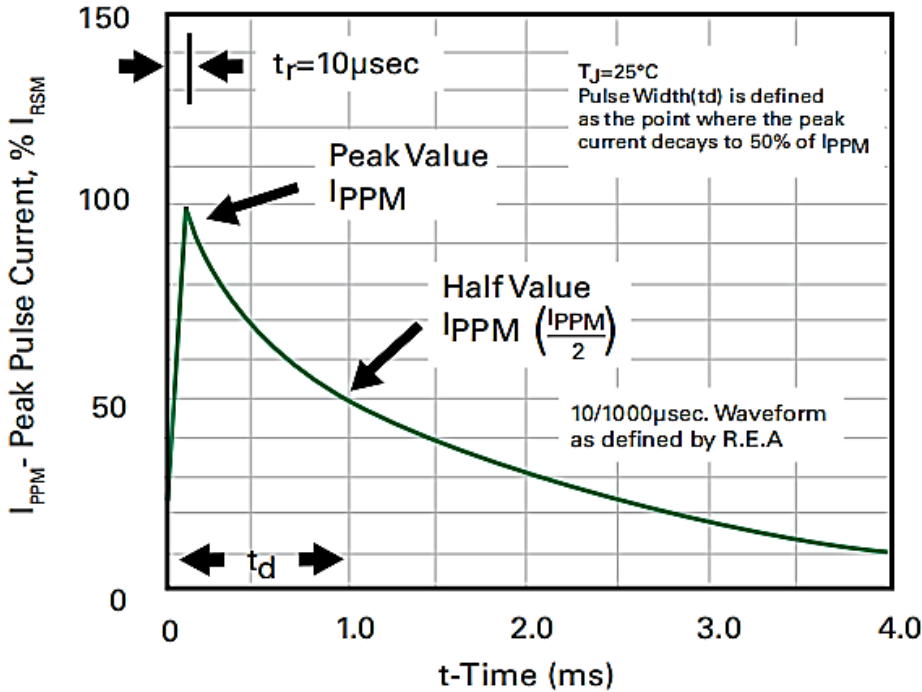
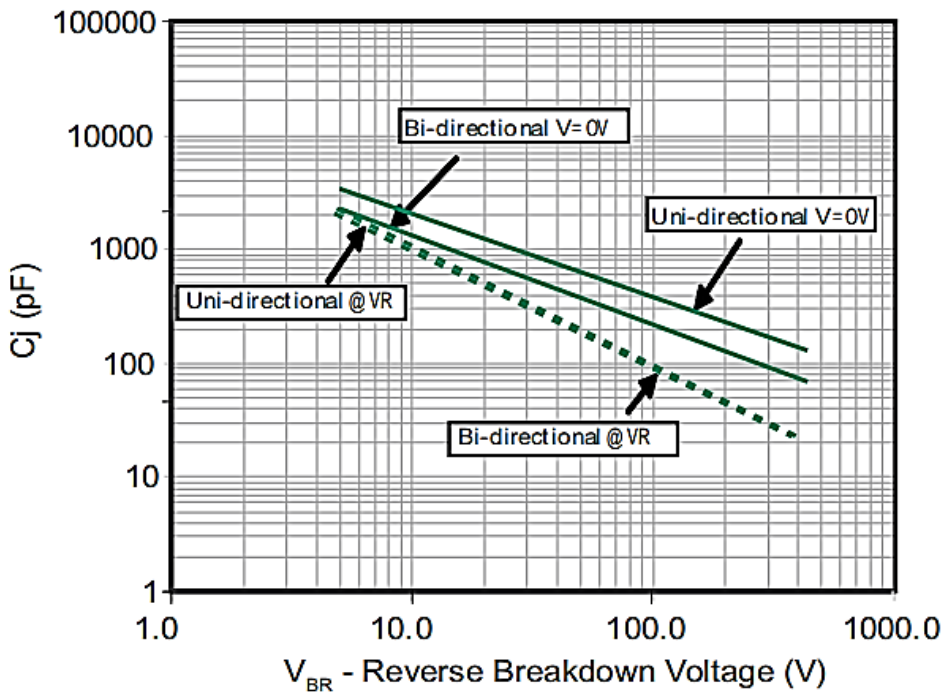

Figure 4 - Typical Junction Capacitance



SMD TRANSIENT VOLTAGE SUPPRESSORS DIODES SMDJ SERIES

RATINGS AND CHARACTERISTIC CURVES (For Reference Only) - $T_a = 25^\circ\text{C}$ Unless Otherwise Specified

Figure 5 - Steady State Power Derating Curve

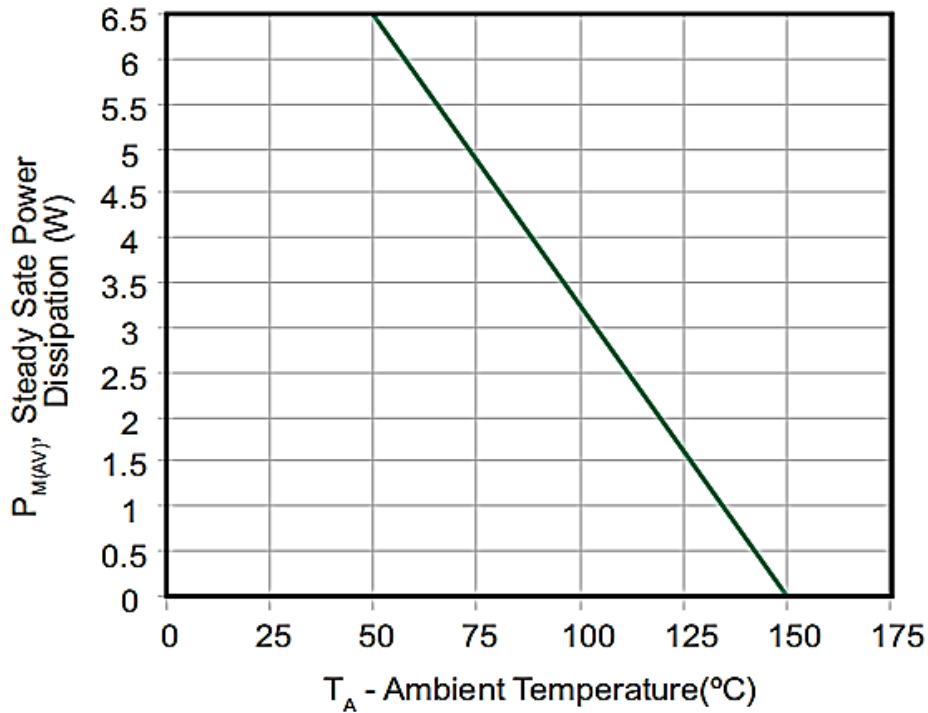
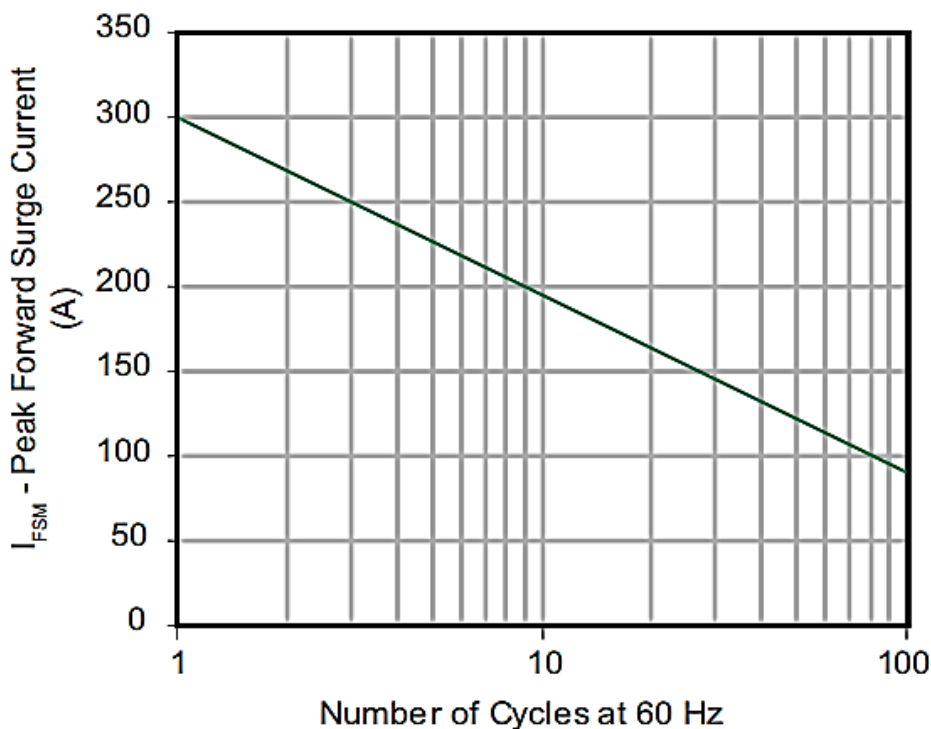

Figure 6 - Maximum Non-Repetitive Peak Forward Surge Current Uni-Directional only



SMD TRANSIENT VOLTAGE SUPPRESSORS DIODES SMDJ SERIES

RATINGS AND CHARACTERISTIC CURVES (For Reference Only) - $T_a = 25^\circ\text{C}$ Unless Otherwise Specified

Figure 7 - Steady State Power Derating
Dissipation Derating Curve

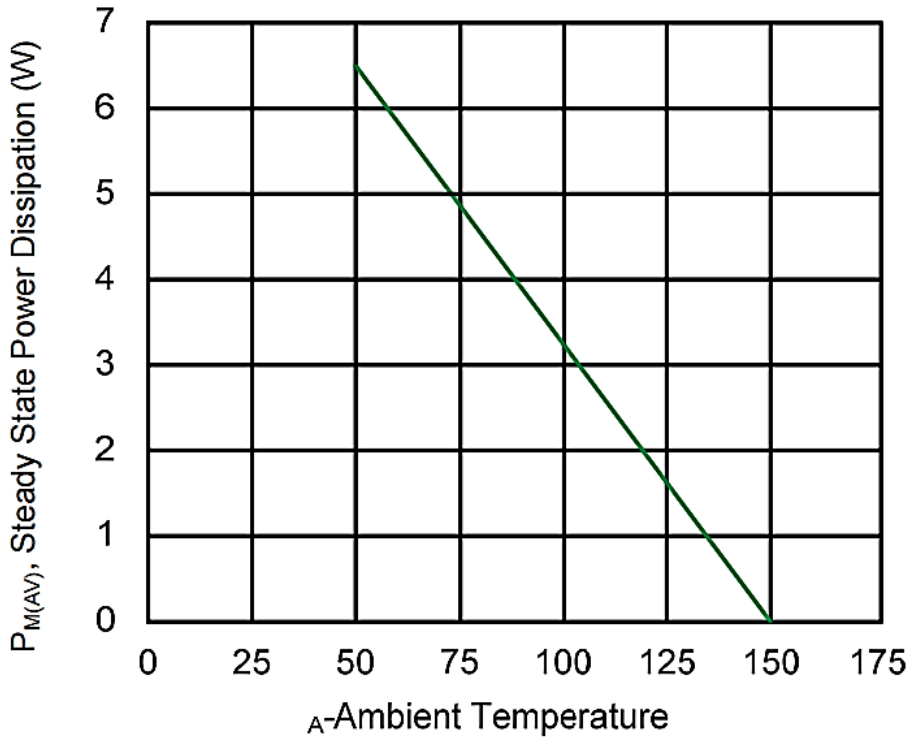
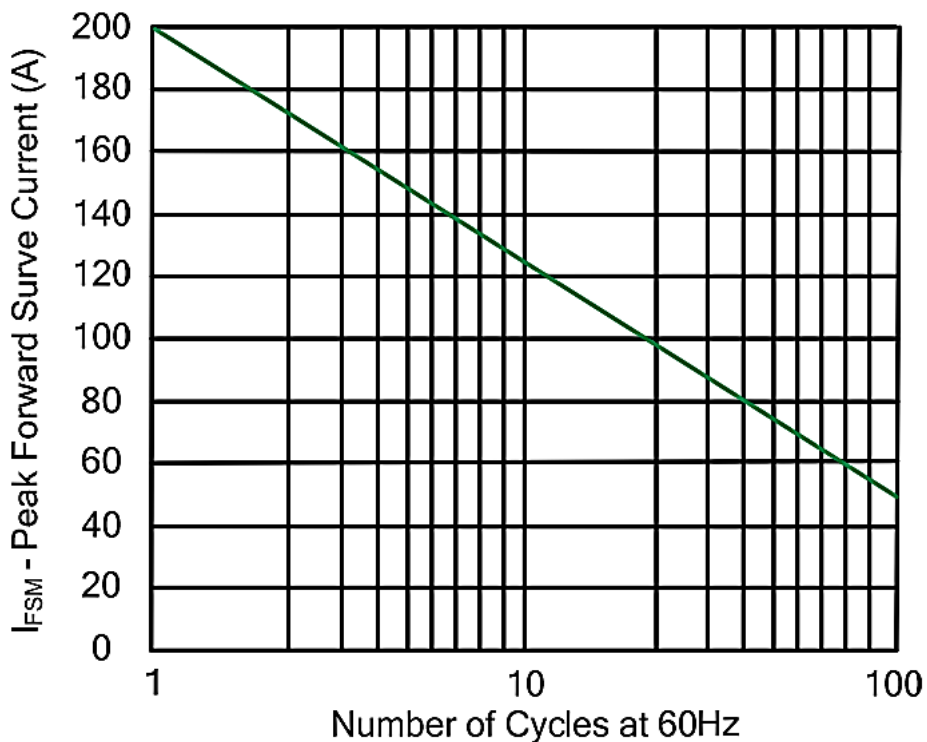

Figure 8 - Maximum Non-Repetitive Forward
Surge Current Uni-Directional only



SMD TRANSIENT VOLTAGE SUPPRESSORS DIODES SMDJ SERIES

TAPE/REEL (Unit: mm)

All Devices are packed in accordance with EIA standard RS-481-A and specifications.

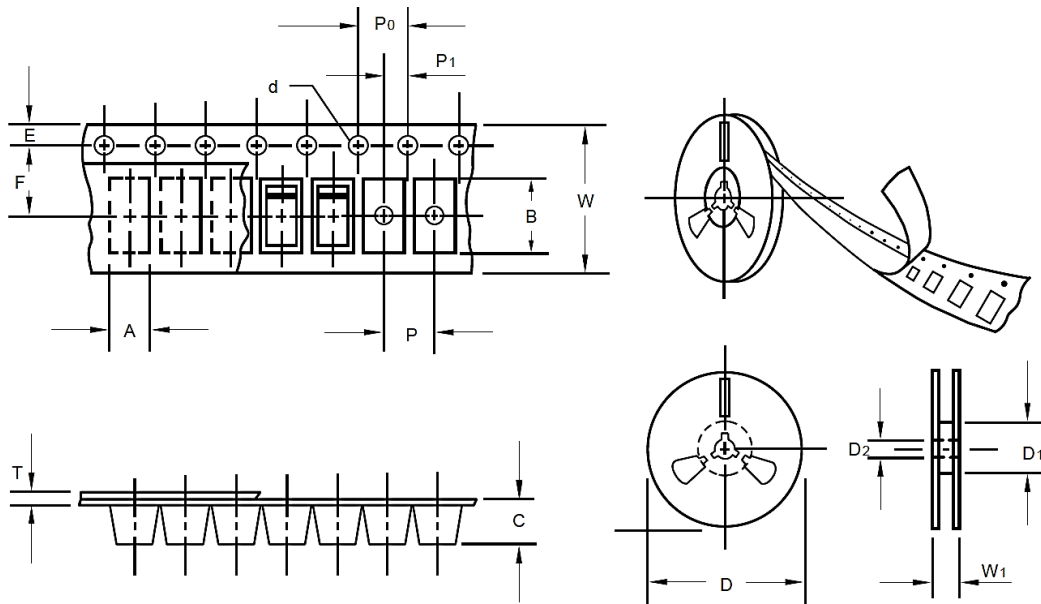

Item	Symbol	Tolerance	SMC/DO-214AB
Carrier width	A	0.1	6.15
Carrier Length	B	0.1	8.41
Carrier Depth	C	0.1	2.42
Sprocket hole	d	0.05	1.50
13"Reel outside diameter	D	2.0	330.0
13"Reel inner diameter	D1	-	50.0Min.
7"Reel outside diameter	D	-	-
7"Reel inner diameter	D1	-	-
Feed hole diameter	D2	0.5	13.00
Sprocket hole position	E	0.1	1.75
Punch hole position	F	0.1	7.50
Punch hole pitch	P	0.1	8.00
Sprocket hole pitch	P0	0.1	4.00
Embossment center	P1	0.1	2.00
Overall tape thickness	T	0.1	0.25
Tape width	W	0.3	16.00
Reel width	W1	1.0	16.50
Package	3000pcs/Reel, 2 Reels/ Box		

SMD TRANSIENT VOLTAGE SUPPRESSORS DIODES SMDJ SERIES

ROHS COMPLIANCE

- The levels of RoHS restricted materials in this product are below the maximum concentration values (also referred to as the threshold limits) permitted for such substances, or are used in an exempted application, in accordance with EU RoHS Directive (EU) 2015/863 EC (RoHS3). [RoHS Test Report](#) for this product can be obtained after clicked.

REACH COMPLIANCE

- REACH substances of high concern (SVHCs) information is available for this product. Since the European Chemical Agency (ECHA) has published notice of their intent to frequently revise the SVHC listing for the foreseeable future, [REACH Test Report](#) for this product can be obtained after clicked.

IMPORTANT NOTES AND DISCLAIMER

- 1) All Product parametric performance is indicated in the Electrical Characteristics for the listed herein test conditions, unless otherwise noted. Product performance may not be indicated by the Electrical Characteristics if operated under different conditions.
- 2) NextGen Component, Inc (*NextGen*) reserves the right to make changes to this document and its products and specifications at any time without notice. Customers should obtain and confirm the latest product information and specifications before final design, purchase or use.
- 3) *NextGen* makes no warranty, representation or guarantee regarding the suitability of its products for any particular purpose, nor does NextGen assume any liability for application assistance or customer product design.
- 4) *NextGen* does not warrant or accept any liability with products which are purchased or used for any unintended or unauthorized application. No license is granted by implication or otherwise under any intellectual property rights of NextGen.
- 5) *NextGen* products are not authorized for use as critical components in life support devices or systems without express written approval by *NextGen*.
- 6) *NextGen* requires that customers first obtain an RMA (Returned Merchandise Authorization) number prior to returning any products. Returns must be made within 30 days of the date of invoice, be in the original packaging, unused and like-new condition. At the time of quoting or purchasing, a product may say that it is Non-Cancelable/ Non-Returnable (NCNR). These products are not returnable and not refundable.