

Ethernet Cable, Cat5e, RJ45 Plug to RJ45 Plug, UTP (Unshielded Twisted Pair), 0.914m, 3 ft.

RoHS
Compliant

Stock No.: CAT5-0031

FEATURES

- RJ45 Plug to RJ45 Plug.
- UTP
- 24 AWG



Product Description

This ethernet cable is Cat 5e rated. With the RJ45 connector, the internet cable could connect the LAN network router, PC, network media players, PoE devices, and another device. This cable could be highly compatible for Power over Ethernet security system, such as PoE security cameras, PoE security NVR, PoE switch etc.

General Specifications

Attribute	Value
Terminated/Unterminated	Terminated
Connector 1	RJ45 Plug
Connector 2	RJ45 Plug
Connector 1 Gender	Male
Connector 2 Gender	Male
Length	0.914m
Gauge	24 AWG
Conductor	CCA
Shielding	Unshielded
Voltage Rating	24V
Current Rating	1.5A
Jacket Color	Grey

Product Drawing

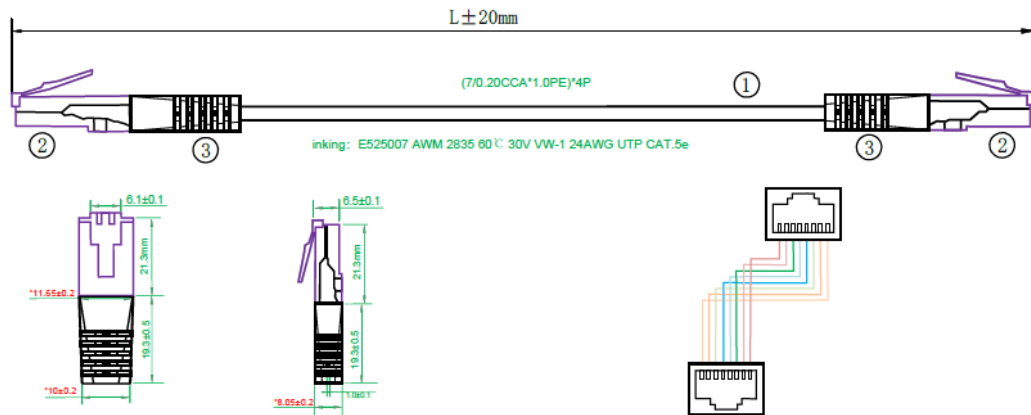

Dimensions: Millimeters (Inches)

Part Number Table

Part Number	Description
CAT5-0031	Ethernet Cable, Cat5e, RJ45 Plug to RJ45 Plug, UTP (Unshielded Twisted Pair), 0.914m, 3 ft.
CAT5-0071	Ethernet Cable, Cat5e, RJ45 Plug to RJ45 Plug, UTP (Unshielded Twisted Pair), 2.1336m, 7 ft.
CAT5-0141	Ethernet Cable, Cat5e, RJ45 Plug to RJ45 Plug, UTP (Unshielded Twisted Pair), 4.2672m, 14 ft.
CAT5-0251	Ethernet Cable, Cat5e, RJ45 Plug to RJ45 Plug, UTP (Unshielded Twisted Pair), 7.62m, 25 ft.
CAT5-0601	Ethernet Cable, Cat5e, RJ45 Plug to RJ45 Plug, UTP (Unshielded Twisted Pair), 18.288m, 60 ft.
CAT5-1001	Ethernet Cable, Cat5e, RJ45 Plug to RJ45 Plug, UTP (Unshielded Twisted Pair), 30.48m, 100 ft.
CAT5-1501	Ethernet Cable, Cat5e, RJ45 Plug to RJ45 Plug, UTP (Unshielded Twisted Pair), 45.72m, 150 ft.

Important Notice: This data sheet and its contents (the "Information") belong to the members of the EASE group of companies (the "Group") or are licensed to it. No license is granted for the use of it other than for information purposes in connection with the products to which it relates. No license of any intellectual property rights is granted. The Information is subject to change without notice and replaces all data sheets previously supplied. The Information supplied is believed to be accurate, but the Group assumes no responsibility for its accuracy or completeness, any error in or omission from it or for any use made of it. Users of this data sheet should check for themselves the Information and the suitability of the products for their purpose and not make any assumptions based on information included or omitted. Liability for loss or damage resulting from any reliance on the Information or use of it (including liability resulting from negligence or where the Group was aware of the possibility of such loss or damage arising) is excluded. This will not operate to limit or restrict the Group's liability for death or personal injury resulting from its negligence. EASE is the registered trademark of Ease Electronics Co., Limited 2019.