



**SPECIFICATION SHEET**

<b>SPECIFICATION SHEET NO.</b>	Q0717- RF01N5R6B250LE
<b>DATE</b>	July 17, 2023
<b>REVISION</b>	A2
<b>DESCRIPTION</b>	Multilayer Ceramic Chip Capacitors RF0201 (0603 Metric) Series, L0.60*W0.30*H0.30mm, Thickness: 0.33mm Max. Dielectric NPO, Capacitance 5.6pF, Tolerance ±0.1pF, Rated Voltage 25V Operating Temp. Range -55°C ~+125°C Package in Tape/Reel, 15,000pcs/Reel RoHS/RoHS III compliant
<b>CUSTOMER</b>	
<b>CUSTOMER PART NUMBER</b>	
<b>CROSS REF. PART NUMBER</b>	
<b>ORIGINAL PART NUMBER</b>	Aillen RF01N5R6B250LE
<b>PART CODE</b>	RF01N5R6B250LE

<b>VENDOR APPROVE</b>			
Issued/Checked/Approved			
DATE: July 17, 2023			

<b>CUSTOMER APPROVE</b>	
DATE:	

## MULTILAYER CERAMIC CHIP CAPACITORS RF SERIES

### MAIN FEATURE

MLCC consists of a conducting material and electrodes. To manufacture a chip-type SMT and achieve miniaturization, high density and high efficiency, ceramic condensers are used. RF series MLCC is used at high frequencies generally have a small temperature coefficient of capacitance, typical within the  $\pm 30\text{ppm}/^\circ\text{C}$  required for NPO (COG) classification and have excellent conductivity internal electrode.

### MAIN FEATURE

- RoHS III Compliant • High Q and low ESR performance at high frequency • Ultra low capacitance to 0.1pF
- Can offer high precision tolerance to  $\pm 0.05\text{pF}$  • Quality improvement of telephone calls for low power loss and better performance.

### APPLICATION

- Mobile phone, WLAN, Base station. • RF module: Power amplifier, VCO. • Tuners.

**RFQ**

[Request For Quotation](#)

### PART CODE GUIDE

Code	Name	Key Specification Option
<b>RF</b>	Product code	RF for high Q and low ESR
<b>01</b>	Size	01005 (0402): L0.40*W0.20mm; <b>0201 (0603): L0.60*W0.30mm;</b> 0402 (1005): L1.00*W0.50mm; 0603 (1608): L1.60*W0.80mm; 0805 (2012): L2.00*W1.25mm; 0505 (1414): L1.40*W1.40mm; 1111 (2828): L2.79*W2.79mm;
<b>N</b>	Dielectric	<b>N: NPO (COG);</b> B: X7R;
<b>5R6</b>	Capacitance	Two significant digits followed by number of Zero, The 3rd digit signifies the multiplying factor, and letter R is decimal point. 0R5: 0.5pF; 3R3:3.3pF; <b>5R6: 5.6pF;</b> 150: 15pF
<b>B</b>	Tolerance	A= $\pm 0.05\text{pF}$ ; <b>B=<math>\pm 0.1\text{pF}</math>;</b> C= $\pm 0.25\text{pF}$ ; D= $\pm 0.5\text{pF}$ ; F= $\pm 1\%$ ; G= $\pm 2\%$ ; J= $\pm 5\%$ ;
<b>250</b>	Rated Voltage	Two significant digits followed by No. of zeros. "R" is in place of decimal point. 6R3=6.3VDC; 101 =100 VDC; 201 =200 VDC; <b>250=25 VDC;</b> 251=250 VDC; 500=50 VDC; 501 =500 VDC;
<b>L</b>	Thickness	V: $0.20 \pm 0.02\text{mm}$ ; <b>L: <math>0.30 \pm 0.03\text{mm}</math>;</b> N: $0.50 \pm 0.05\text{mm}$ ; H: $0.50 \pm 0.10\text{mm}$ A: $0.60 \pm 0.10\text{mm}$ ; S: $0.80 \pm 0.07\text{mm}$ ; T: $0.80 \pm 0.10\text{mm}$ ; J: $1.15 \pm 0.15\text{mm}$ ;
<b>E</b>	Package	A: 1Kpcs/Reel; B: 2Kpcs/Reel; C: 3Kpcs/Reel; D: 4Kpcs/Reel; <b>E: 15Kpcs/Reel</b> I: 10Kpcs/Reel; F: others
	Internal Control	Internal Code: Letter + Number; Blank: N/A;

**MULTILAYER CERAMIC CHIP CAPACITORS RF SERIES**

**DIMENSION (Unit: mm)**



Image for reference

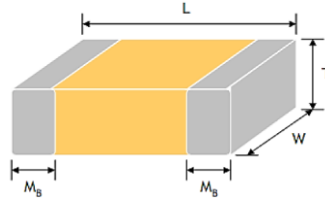

**Table 1**

Size Code	L	W	T (Symbol )		Remark	M B
<b>01005</b> (0402)	0.40±0.02	0.20±0.02	0.20±0.02	V	#	0.10+0.03
<b>0201</b> (0603)	0.60±0.03	0.30±0.03	0.3±0.03	L	#	0.15+0.05
<b>0402</b> (1005)	1.00±0.05	0.50±0.05	0.50±0.05	N	#	0.25+0.05/-0.10
<b>0603</b> (1608)	1.60 ± 0.10	0.80 ± 0.10	0.80 ± 0.07	S		0.40±0.15
	1.60+0.15/-0.10	0.80+0.15/-0.10	0.50 ± 0.10	H		
<b>0805</b> (2012)	2.00±0.15	1.25±0.10	0.60 ± 0.10	A		0.50±0.20
	2.00±0.20	1.25±0.20	0.85 ± 0.10	T		
<b>0505</b> (1414)	1.40 +0.38/-0.25	1.40 ± 0.38	1.15 ± 0.15	J	#	0.25+0.25/-0.13
<b>1111</b> (2828)	2.79 +0.51/-0.25	2.79 ± 0.38	≤ 1.78	G	#	0.38±0.25

# Reflow soldering only is recommended.

**MULTILAYER CERAMIC CHIP CAPACITORS RF SERIES**
**GENERAL ELECTRONICAL CHARACTERISTICS**
*Table 2*

<b>Dielectric</b>	NPO
<b>Size</b>	01005, 0201, 0402, 0505, 0603, 0805, 1111
<b>Capacitance range*</b>	0.1pF to 1000pF
<b>Capacitance Tolerance</b>	Cap≤5pF: A (±0.05pF), B (±0.1pF), C (±0.25pF) 5pF<Cap<10pF: B (±0.1pF), C (±0.25pF), D (±0.5pF) Cap≥10pF: F (±1%), G (±2%), J (±5%)
<b>Rated Voltage</b>	6.3V, 10V, 25V, 50V, 100V, 200V, 250V, 500V
<b>Q*</b>	01005, 0201, 0402/25V~50V: Cap<30pF:Q≥400+20C; Cap≥30pF:Q≥1000 0402/100V~200V, 0603, 0805, 0505, 1111: Cap<30pF:Q≥800+20C; Cap≥30pF:Q≥1400
<b>Insulation resistance at Ur</b>	≥10GΩ or RxC≥100Ω-F whichever is smaller.
<b>Operating Temperature</b>	-55 ~+125°C
<b>Capacitance change</b>	±30ppm/° C; 0201Cap≥22pF, ±60ppm/° C
<b>Termination</b>	Ni/Sn (lead-free termination)

Note:

- 1) \* Measured at the condition of 30~70% related humidity.
- 2) Apply 1.0±0.2Vrms, 1.0MHz±10% for Cap≤1000pF and 1.0±0.2Vrms, 1.0kHz±10% for Cap>1000pF, 25°C at ambient temperature.

**MULTILAYER CERAMIC CHIP CAPACITORS RF SERIES**

**CAPACITANCE RANGE - NP0 DIELECTRIC 01005 SIZES**

*Table 3-A*

Size	01005		Tolerance
	16	25	
RATED VOLTAGE (VDC)			
0.2pF (OR2)	V	V	A, B
0.3pF (OR3)	V	V	A, B
0.4pF (OR4)	V	V	A, B
0.5pF (OR5)	V	V	A, B, C
0.6pF (OR6)	V	V	A, B, C
0.7pF (OR7)	V	V	A, B, C
0.75pF (R75)	V	V	A, B, C
0.8pF (OR8)	V	V	A, B, C
0.9pF (OR9)	V	V	A, B, C
1.0pF (1R0)	V	V	A, B, C
1.2pF (1R2)	V	V	A, B, C
1.5pF (1R5)	V	V	A, B, C
1.8pF (1R8)	V	V	A, B, C
2.0pF (2R0)	V	V	A, B, C
2.2pF (2R2)	V	V	A, B, C
2.7pF (2R7)	V	V	A, B, C
3.0pF (3R0)	V	V	A, B, C
3.3pF (3R3)	V	V	A, B, C
3.9pF (3R9)	V	V	A, B, C
4.0pF (4R0)	V	V	A, B, C
4.7pF (4R7)	V	V	A, B, C
5.0pF (5R0)	V	V	A, B, C
5.6pF (5R6)	V	V	B, C, D
6.0pF (6R0)	V	V	B, C, D
6.8pF (6R8)	V		B, C, D
7.0pF (7R0)	V		B, C, D
8.0pF (8R0)	V		B, C, D
8.2pF (8R2)	V		B, C, D
9.0pF (9R0)	V		B, C, D
10pF (100)	V	V	C, D, G
12pF (120)	V	V	J
15pF (150)	V	V	J
20pF (200)	V	V	J
22pF (220)	V	V	J

**MULTILAYER CERAMIC CHIP CAPACITORS RF SERIES**

**CAPACITANCE RANGE - NP0 DIELECTRIC 0201, 0402 SIZES**

*Table 3-B*

Size	0201				0402				Tolerance
	6.3	10	25	50	25	50	100	200	
RATED VOLTAGE (VDC)									
0.1pF (0R1)	L	L	L	L	N	N	N	N	B
0.2pF (0R2)	L	L	L	L	N	N	N	N	A, B
0.3pF (0R3)	L	L	L	L	N	N	N	N	A, B
0.4pF (0R4)	L	L	L	L	N	N	N	N	A, B
0.5pF (0R5)	L	L	L	L	N	N	N	N	A, B, C
0.6pF (0R6)	L	L	L	L	N	N	N	N	A, B, C
0.7pF (0R7)	L	L	L	L	N	N	N	N	A, B, C
0.75pF (R75)	L	L	L	L	N	N	N	N	A, B, C
0.8pF (0R8)	L	L	L	L	N	N	N	N	A, B, C
0.9pF (0R9)	L	L	L	L	N	N	N	N	A, B, C
1.0pF (1R0)	L	L	L	L	N	N	N	N	A, B, C
1.1pF (1R1)	L	L	L	L	N	N	N	N	A, B, C
1.2pF (1R2)	L	L	L	L	N	N	N	N	A, B, C
1.3pF (1R3)	L	L	L	L	N	N	N	N	A, B, C
1.4pF (1R4)	L	L	L	L	N	N	N	N	A, B, C
1.5pF (1R5)	L	L	L	L	N	N	N	N	A, B, C
1.6pF (1R6)	L	L	L	L	N	N	N	N	A, B, C
1.7pF (1R7)	L	L	L	L	N	N	N	N	A, B, C
1.8pF (1R8)	L	L	L	L	N	N	N	N	A, B, C
1.9pF (1R9)	L	L	L	L	N	N	N	N	A, B, C
2.0pF (2R0)	L	L	L	L	N	N	N	N	A, B, C
2.1pF (2R1)	L	L	L	L	N	N	N	N	A, B, C
2.2pF (2R2)	L	L	L	L	N	N	N	N	A, B, C
2.3pF (2R3)	L	L	L	L	N	N	N	N	A, B, C
2.4pF (2R4)	L	L	L	L	N	N	N	N	A, B, C
2.5pF (2R5)	L	L	L	L	N	N	N	N	A, B, C
2.6pF (2R6)	L	L	L	L	N	N	N	N	A, B, C
2.7pF (2R7)	L	L	L	L	N	N	N	N	A, B, C
2.8pF (2R8)	L	L	L	L	N	N	N	N	A, B, C
2.9pF (2R9)	L	L	L	L	N	N	N	N	A, B, C
3.0pF (3R0)	L	L	L	L	N	N	N	N	A, B, C
3.1pF (3R1)	L	L	L	L	N	N	N	N	A, B, C
3.2pF (3R2)	L	L	L	L	N	N	N	N	A, B, C
3.3pF (3R3)	L	L	L	L	N	N	N	N	A, B, C
3.4pF (3R4)	L	L	L	L	N	N	N	N	A, B, C

**MULTILAYER CERAMIC CHIP CAPACITORS RF SERIES**

**CAPACITANCE RANGE - NP0 DIELECTRIC 0201, 0402 SIZES**

*Table 3-C*

Size	0201				0402				Tolerance
RATED VOLTAGE (VDC)	6.3	10	25	50	25	50	100	200	
3.5pF (3R5)	L	L	L	L	N	N	N	N	A, B, C
3.6pF (3R6)	L	L	L	L	N	N	N	N	A, B, C
3.7pF (3R7)	L	L	L	L	N	N	N	N	A, B, C
3.8pF (3R8)	L	L	L	L	N	N	N	N	A, B, C
3.9pF (3R9)	L	L	L	L	N	N	N	N	A, B, C
4.0pF (4R0)	L	L	L	L	N	N	N	N	A, B, C
4.1pF (4R1)	L	L	L	L	N	N	N	N	A, B, C
4.2pF (4R2)	L	L	L	L	N	N	N	N	A, B, C
4.3pF (4R3)	L	L	L	L	N	N	N	N	A, B, C
4.4pF (4R4)	L	L	L	L	N	N	N	N	A, B, C
4.5pF (4R5)	L	L	L	L	N	N	N	N	A, B, C
4.6pF (4R6)	L	L	L	L	N	N	N	N	A, B, C
4.7pF (4R7)	L	L	L	L	N	N	N	N	A, B, C
4.8pF (4R8)	L	L	L	L	N	N	N	N	A, B, C
4.9pF (4R9)	L	L	L	L	N	N	N	N	A, B, C
5.0pF (5R0)	L	L	L	L	N	N	N	N	A, B, C
5.1pF (5R1)	L	L	L	L	N	N	N	N	B, C, D
5.2pF (5R2)	L	L	L	L	N	N	N	N	B, C, D
5.3pF (5R3)	L	L	L	L	N	N	N	N	B, C, D
5.4pF (5R4)	L	L	L	L	N	N	N	N	B, C, D
5.5pF (5R5)	L	L	L	L	N	N	N	N	B, C, D
5.6pF (5R6)	L	L	L	L	N	N	N	N	B, C, D
5.7pF (5R7)	L	L	L	L	N	N	N	N	B, C, D
5.8pF (5R8)	L	L	L	L	N	N	N	N	B, C, D
5.9pF (5R9)	L	L	L	L	N	N	N	N	B, C, D
6.0pF (6R0)	L	L	L	L	N	N	N	N	B, C, D
6.1pF (6R1)	L	L	L	L	N	N	N	N	B, C, D
6.2pF (6R2)	L	L	L	L	N	N	N	N	B, C, D
6.3pF (6R3)	L	L	L	L	N	N	N	N	B, C, D
6.4pF (6R4)	L	L	L	L	N	N	N	N	B, C, D
6.5pF (6R5)	L	L	L	L	N	N	N	N	B, C, D
6.6pF (6R6)	L	L	L	L	N	N	N	N	B, C, D
6.7pF (6R7)	L	L	L	L	N	N	N	N	B, C, D
6.8pF (6R8)	L	L	L	L	N	N	N	N	B, C, D
6.9pF (6R9)	L	L	L	L	N	N	N	N	B, C, D

**MULTILAYER CERAMIC CHIP CAPACITORS RF SERIES**

**CAPACITANCE RANGE - NP0 DIELECTRIC 0201, 0402 SIZES**

*Table 3-D*

Size	0201				0402				Tolerance
RATED VOLTAGE (VDC)	6.3	10	25	50	25	50	100	200	
7.0pF (7R0)	L	L	L	L	N	N	N	N	B, C, D
7.1pF (7R1)	L	L	L	L	N	N	N	N	B, C, D
7.2pF (7R2)	L	L	L	L	N	N	N	N	B, C, D
7.3pF (7R3)	L	L	L	L	N	N	N	N	B, C, D
7.4pF (7R4)	L	L	L	L	N	N	N	N	B, C, D
7.5pF (7R5)	L	L	L	L	N	N	N	N	B, C, D
7.6pF (7R6)	L	L	L	L	N	N	N	N	B, C, D
7.7pF (7R7)	L	L	L	L	N	N	N	N	B, C, D
7.8pF (7R8)	L	L	L	L	N	N	N	N	B, C, D
7.9pF (7R9)	L	L	L	L	N	N	N	N	B, C, D
8.0pF (8R0)	L	L	L	L	N	N	N	N	B, C, D
8.1pF (8R1)	L	L	L	L	N	N	N	N	B, C, D
8.2pF (8R2)	L	L	L	L	N	N	N	N	B, C, D
8.3pF (8R3)	L	L	L	L	N	N	N	N	B, C, D
8.4pF (8R4)	L	L	L	L	N	N	N	N	B, C, D
8.5pF (8R5)	L	L	L	L	N	N	N	N	B, C, D
8.6pF (8R6)	L	L	L	L	N	N	N	N	B, C, D
8.7pF (8R7)	L	L	L	L	N	N	N	N	B, C, D
8.8pF (8R8)	L	L	L	L	N	N	N	N	B, C, D
8.9pF (8R9)	L	L	L	L	N	N	N	N	B, C, D
9.0pF (9R0)	L	L	L	L	N	N	N	N	B, C, D
9.1pF (9R1)	L	L	L	L	N	N	N	N	B, C, D
9.2pF (9R2)	L	L	L	L	N	N	N	N	B, C, D
9.3pF (9R3)	L	L	L	L	N	N	N	N	B, C, D
9.4pF (9R4)	L	L	L	L	N	N	N	N	B, C, D
9.5pF (9R5)	L	L	L	L	N	N	N	N	B, C, D
9.6pF (9R6)	L	L	L	L	N	N	N	N	B, C, D
9.7pF (9R7)	L	L	L	L	N	N	N	N	B, C, D
9.8pF (9R8)	L	L	L	L	N	N	N	N	B, C, D
9.9pF (9R9)	L	L	L	L	N	N	N	N	B, C, D
10pF (100)	L	L	L	L	N	N	N	N	F, G, J
11pF (110)	L	L	L	L	N	N	N	N	F, G, J
12pF (120)	L	L	L	L	N	N	N	N	F, G, J
13pF (130)	L	L	L	L	N	N	N	N	F, G, J
15pF (150)	L	L	L	L	N	N	N	N	F, G, J



**MULTILAYER CERAMIC CHIP CAPACITORS RF SERIES**
**CAPACITANCE RANGE - NP0 DIELECTRIC 0201, 0402 SIZES**
*Table 3-E*

Size	0201				0402				Tolerance
RATED VOLTAGE (VDC)	6.3	10	25	50	25	50	100	200	
16pF (160)	L	L	L	L	N	N	N	N	F, G, J
18pF (180)	L	L	L	L	N	N	N	N	F, G, J
20pF (200)	L	L	L	L	N	N	N	N	F, G, J
22pF (220)	L	L	L		N	N	N	N	F, G, J
24pF (240)	L	L	L		N	N	N	N	F, G, J
27pF (270)	L	L	L		N	N	N	N	F, G, J
30pF (300)	L	L	L		N	N	N	N	F, G, J
33pF (330)	L	L	L		N	N	N	N	F, G, J
36pF (360)					N	N	N		F, G, J
39pF (390)					N	N	N		F, G, J
43pF (430)					N	N	N		F, G, J
47pF (470)					N	N	N		F, G, J
56pF (560)					N	N	N		F, G, J
68pF (680)					N	N			F, G, J
82pF (820)					N	N			F, G, J
100pF (101)					N	N			F, G, J

**CAPACITANCE RANGE - NP0 DIELECTRIC 0505, 0603, 0805 SIZES**
*Table 3-F*

Size	0505			0603			0805				Tolerance
RATED VOLTAGE (VDC)	50	100	250	50	100	250	50	100	250	500	
0.1pF (0R1)				H	H	H					A, B
0.2pF (0R2)				H	H	H	A	A	A	A	A, B
0.3pF (0R3)				S	S	S	T	T	T	T	A, B
0.4pF (0R4)	J	J	J	S	S	S	T	T	T	T	A, B
0.5pF (0R5)	J	J	J	S	S	S	T	T	T	T	A, B, C
0.6pF (0R6)	J	J	J	S	S	S	T	T	T	T	A, B, C
0.7pF (0R7)	J	J	J	S	S	S	T	T	T	T	A, B, C
0.8pF (0R8)	J	J	J	S	S	S	T	T	T	T	A, B, C
0.9pF (0R9)	J	J	J	S	S	S	T	T	T	T	A, B, C
1.0pF (1R0)	J	J	J	S	S	S	T	T	T	T	A, B, C
1.1pF (1R1)	J	J	J	S	S	S	T	T	T	T	A, B, C
1.2pF (1R2)	J	J	J	S	S	S	T	T	T	T	A, B, C
1.3pF (1R3)	J	J	J	S	S	S	T	T	T	T	A, B, C
1.4pF (1R4)	J	J	J	S	S	S	T	T	T	T	A, B, C

**MULTILAYER CERAMIC CHIP CAPACITORS RF SERIES**

**CAPACITANCE RANGE - NPO DIELECTRIC 0505, 0603, 0805 SIZES**

*Table 3-G*

Size RATED VOLTAGE (VDC)	0505			0603			0805				Tolerance
	50	100	250	50	100	250	50	100	250	500	
1.5pF (1R5)	J	J	J	S	S	S	T	T	T	T	A, B, C
1.6pF (1R6)	J	J	J	S	S	S	T	T	T	T	A, B, C
1.7pF (1R7)	J	J	J	S	S	S	T	T	T	T	A, B, C
1.8pF (1R8)	J	J	J	S	S	S	T	T	T	T	A, B, C
1.9pF (1R9)	J	J	J	S	S	S	T	T	T	T	A, B, C
2.0pF (2R0)	J	J	J	S	S	S	T	T	T	T	A, B, C
2.1pF (2R1)	J	J	J	S	S	S	T	T	T	T	A, B, C
2.2pF (2R2)	J	J	J	S	S	S	T	T	T	T	A, B, C
2.3pF (2R3)	J	J	J	S	S	S	T	T	T	T	A, B, C
2.4pF (2R4)	J	J	J	S	S	S	T	T	T	T	A, B, C
2.5pF (2R5)	J	J	J	S	S	S	T	T	T	T	A, B, C
2.6pF (2R6)	J	J	J	S	S	S	T	T	T	T	A, B, C
2.7pF (2R7)	J	J	J	S	S	S	T	T	T	T	A, B, C
2.8pF (2R8)	J	J	J	S	S	S	T	T	T	T	A, B, C
2.9pF (2R9)	J	J	J	S	S	S	T	T	T	T	A, B, C
3.0pF (3R0)	J	J	J	S	S	S	T	T	T	T	A, B, C
3.1pF (3R1)	J	J	J	S	S	S	T	T	T	T	A, B, C
3.2pF (3R2)	J	J	J	S	S	S	T	T	T	T	A, B, C
3.3pF (3R3)	J	J	J	S	S	S	T	T	T	T	A, B, C
3.4pF (3R4)	J	J	J	S	S	S	T	T	T	T	A, B, C
3.5pF (3R5)	J	J	J	S	S	S	T	T	T	T	A, B, C
3.6pF (3R6)	J	J	J	S	S	S	T	T	T	T	A, B, C
3.7pF (3R7)	J	J	J	S	S	S	T	T	T	T	A, B, C
3.8pF (3R8)	J	J	J	S	S	S	T	T	T	T	A, B, C
3.9pF (3R9)	J	J	J	S	S	S	T	T	T	T	A, B, C
4.0pF (4R0)	J	J	J	S	S	S	T	T	T	T	A, B, C
4.1pF (4R1)	J	J	J	S	S	S	T	T	T	T	A, B, C
4.2pF (4R2)	J	J	J	S	S	S	T	T	T	T	A, B, C
4.3pF (4R3)	J	J	J	S	S	S	T	T	T	T	A, B, C
4.4pF (4R4)	J	J	J	S	S	S	T	T	T	T	A, B, C
4.5pF (4R5)	J	J	J	S	S	S	T	T	T	T	A, B, C
4.6pF (4R6)	J	J	J	S	S	S	T	T	T	T	A, B, C
4.7pF (4R7)	J	J	J	S	S	S	T	T	T	T	A, B, C
4.8pF (4R8)	J	J	J	S	S	S	T	T	T	T	A, B, C

**MULTILAYER CERAMIC CHIP CAPACITORS RF SERIES**

**CAPACITANCE RANGE - NP0 DIELECTRIC 0505, 0603, 0805 SIZES**

*Table 3-H*

Size RATED VOLTAGE (VDC)	0505			0603			0805				Tolerance
	50	100	250	50	100	250	50	100	250	500	
4.9pF (4R9)	J	J	J	S	S	S	T	T	T	T	A, B, C
5.0pF (5R0)	J	J	J	S	S	S	T	T	T	T	A, B, C
5.1pF (5R1)	J	J	J	S	S	S	T	T	T	T	B, C, D
5.2pF (5R2)	J	J	J	S	S	S	T	T	T	T	B, C, D
5.3pF (5R3)	J	J	J	S	S	S	T	T	T	T	B, C, D
5.4pF (5R4)	J	J	J	S	S	S	T	T	T	T	B, C, D
5.5pF (5R5)	J	J	J	S	S	S	T	T	T	T	B, C, D
5.6pF (5R6)	J	J	J	S	S	S	T	T	T	T	B, C, D
5.7pF (5R7)	J	J	J	S	S	S	T	T	T	T	B, C, D
5.8pF (5R8)	J	J	J	S	S	S	T	T	T	T	B, C, D
5.9pF (5R9)	J	J	J	S	S	S	T	T	T	T	B, C, D
6.0pF (6R0)	J	J	J	S	S	S	T	T	T	T	B, C, D
6.1pF (6R1)	J	J	J	S	S	S	T	T	T	T	B, C, D
6.2pF (6R2)	J	J	J	S	S	S	T	T	T	T	B, C, D
6.3pF (6R3)	J	J	J	S	S	S	T	T	T	T	B, C, D
6.4pF (6R4)	J	J	J	S	S	S	T	T	T	T	B, C, D
6.5pF (6R5)	J	J	J	S	S	S	T	T	T	T	B, C, D
6.6pF (6R6)	J	J	J	S	S	S	T	T	T	T	B, C, D
6.7pF (6R7)	J	J	J	S	S	S	T	T	T	T	B, C, D
6.8pF (6R8)	J	J	J	S	S	S	T	T	T	T	B, C, D
6.9pF (6R9)	J	J	J	S	S	S	T	T	T	T	B, C, D
7.0pF (7R0)	J	J	J	S	S	S	T	T	T	T	B, C, D
7.1pF (7R1)	J	J	J	S	S	S	T	T	T	T	B, C, D
7.2pF (7R2)	J	J	J	S	S	S	T	T	T	T	B, C, D
7.3pF (7R3)	J	J	J	S	S	S	T	T	T	T	B, C, D
7.4pF (7R4)	J	J	J	S	S	S	T	T	T	T	B, C, D
7.5pF (7R5)	J	J	J	S	S	S	T	T	T	T	B, C, D
7.6pF (7R6)	J	J	J	S	S	S	T	T	T	T	B, C, D
7.7pF (7R7)	J	J	J	S	S	S	T	T	T	T	B, C, D
7.8pF (7R8)	J	J	J	S	S	S	T	T	T	T	B, C, D
7.9pF (7R9)	J	J	J	S	S	S	T	T	T	T	B, C, D
8.0pF (8R0)	J	J	J	S	S	S	T	T	T	T	B, C, D
8.1pF (8R1)	J	J	J	S	S	S	T	T	T	T	B, C, D
8.2pF (8R2)	J	J	J	S	S	S	T	T	T	T	B, C, D

**MULTILAYER CERAMIC CHIP CAPACITORS RF SERIES**

**CAPACITANCE RANGE - NPO DIELECTRIC 0505, 0603, 0805 SIZES**

*Table 3-1*

Size	0505			0603			0805				Tolerance
	RATED VOLTAGE (VDC)	50	100	250	50	100	250	50	100	250	
8.3pF (8R3)	J	J	J	S	S	S	T	T	T	T	B, C, D
8.4pF (8R4)	J	J	J	S	S	S	T	T	T	T	B, C, D
8.5pF (8R5)	J	J	J	S	S	S	T	T	T	T	B, C, D
8.6pF (8R6)	J	J	J	S	S	S	T	T	T	T	B, C, D
8.7pF (8R7)	J	J	J	S	S	S	T	T	T	T	B, C, D
8.8pF (8R8)	J	J	J	S	S	S	T	T	T	T	B, C, D
8.9pF (8R9)	J	J	J	S	S	S	T	T	T	T	B, C, D
9.0pF (9R0)	J	J	J	S	S	S	T	T	T	T	B, C, D
9.1pF (9R1)	J	J	J	S	S	S	T	T	T	T	B, C, D
9.2pF (9R2)	J	J	J	S	S	S	T	T	T	T	B, C, D
9.3pF (9R3)	J	J	J	S	S	S	T	T	T	T	B, C, D
9.4pF (9R4)	J	J	J	S	S	S	T	T	T	T	B, C, D
9.5pF (9R5)	J	J	J	S	S	S	T	T	T	T	B, C, D
9.6pF (9R6)	J	J	J	S	S	S	T	T	T	T	B, C, D
9.7pF (9R7)	J	J	J	S	S	S	T	T	T	T	B, C, D
9.8pF (9R8)	J	J	J	S	S	S	T	T	T	T	B, C, D
9.9pF (9R9)	J	J	J	S	S	S	T	T	T	T	B, C, D
10pF (100)	J	J	J	S	S	S	T	T	T	T	F, G, J
11pF (110)	J	J	J	S	S	S	T	T	T	T	F, G, J
12pF (120)	J	J	J	S	S	S	T	T	T	T	F, G, J
13pF (130)	J	J	J	S	S	S	T	T	T	T	F, G, J
15pF (150)	J	J	J	S	S	S	T	T	T	T	F, G, J
16pF (160)	J	J	J	S	S	S	T	T	T	T	F, G, J
18pF (180)	J	J	J	S	S	S	T	T	T	T	F, G, J
20pF (200)	J	J	J	S	S	S	T	T	T	T	F, G, J
22pF (220)	J	J	J	S	S	S	T	T	T	T	F, G, J
24pF (240)	J	J	J	S	S	S	T	T	T	T	F, G, J
27pF (270)	J	J	J	S	S	S	T	T	T	T	F, G, J
30pF (300)	J	J	J	S	S	S	T	T	T	T	F, G, J
33pF (330)	J	J	J	S	S	S	T	T	T	T	F, G, J
36pF (360)	J	J	J	S	S	S	T	T	T	T	F, G, J
39pF (390)	J	J	J	S	S	S	T	T	T	T	F, G, J
43pF (430)	J	J	J	S	S	S	T	T	T	T	F, G, J
47pF (470)	J	J	J	S	S	S	T	T	T	T	F, G, J

**MULTILAYER CERAMIC CHIP CAPACITORS RF SERIES**

**CAPACITANCE RANGE - NPO DIELECTRIC 0505, 0603, 0805 SIZES**

*Table 3-J*

Size	0505			0603			0805				Tolerance
	RATED VOLTAGE (VDC)	50	100	250	50	100	250	50	100	250	
56pF (560)	J	J	J	S	S	S	T	T	T	T	F, G, J
68pF (680)	J	J	J	S	S	S	T	T	T	T	F, G, J
82pF (820)	J	J	J	S	S	S	T	T	T		F, G, J
100pF (101)	J	J	J	S	S	S	T	T	T		F, G, J
120pF (120)							T	T	T		F, G, J
150pF (150)							T	T	T		F, G, J
180pF (180)							T	T	T		F, G, J
220pF (221)							T	T	T		F, G, J

**CAPACITANCE RANGE - NPO DIELECTRIC 1111 SIZES**

*Table 3-K*

Size	1111					Tolerance
	RATED VOLTAGE (VDC)	50	100	200	250	
2.0pF (2R0)	G	G	G	G	G	A, B, C
2.2pF (2R2)	G	G	G	G	G	A, B, C
2.7pF (2R7)	G	G	G	G	G	A, B, C
3.3pF (3R3)	G	G	G	G	G	A, B, C
3.9pF (3R9)	G	G	G	G	G	A, B, C
4.7pF (4R7)	G	G	G	G	G	A, B, C
5.6pF (5R6)	G	G	G	G	G	B, C, D
6.8pF (6R8)	G	G	G	G	G	B, C, D
8.2pF (8R2)	G	G	G	G	G	B, C, D
10pF (100)	G	G	G	G	G	F, G, J
12pF (120)	G	G	G	G	G	F, G, J
15pF (150)	G	G	G	G	G	F, G, J
18pF (180)	G	G	G	G	G	F, G, J
22pF (220)	G	G	G	G	G	F, G, J
27pF (270)	G	G	G	G	G	F, G, J
33pF (330)	G	G	G	G	G	F, G, J
39pF (390)	G	G	G	G	G	F, G, J
47pF (470)	G	G	G	G	G	F, G, J
56pF (560)	G	G	G	G	G	F, G, J
68pF (680)	G	G	G	G	G	F, G, J
82pF (820)	G	G	G	G	G	F, G, J
100pF (101)	G	G	G	G	G	F, G, J

**MULTILAYER CERAMIC CHIP CAPACITORS RF SERIES**

**CAPACITANCE RANGE - NP0 DIELECTRIC 1111 SIZES**

*Table 3-L*

Size	1111					Tolerance
	50	100	200	250	500	
<b>RATED VOLTAGE (VDC)</b>	50	100	200	250	500	
120pF (121)	G	G	G	G	G	F, G, J
150pF (151)	G	G	G	G	G	F, G, J
180pF (181)	G	G	G	G	G	F, G, J
220pF (221)	G	G	G	G	G	F, G, J
270pF (271)	G	G	G	G	G	F, G, J
330pF (331)	G	G	G	G	G	F, G, J
390pF (391)	G	G	G	G	G	F, G, J
470pF (471)	G	G	G	G	G	F, G, J
560pF (561)	G	G	G	G	G	F, G, J
680pF (681)	G	G	G	G	G	F, G, J
820pF (821)	G	G	G	G	G	F, G, J
1000pF (102)	G	G	G	G	G	F, G, J

**ELECTRICAL CHARACTERISTICS**

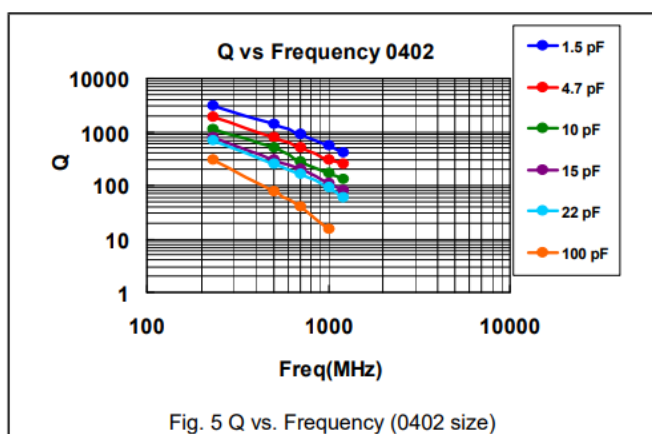
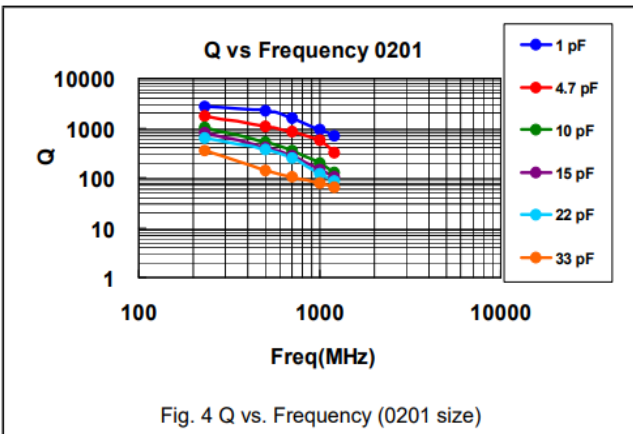
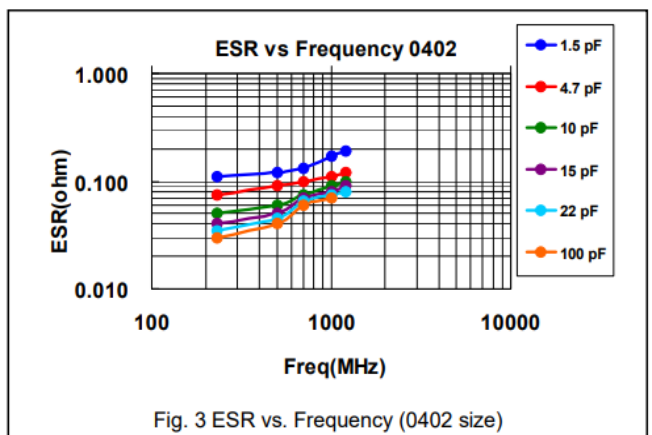
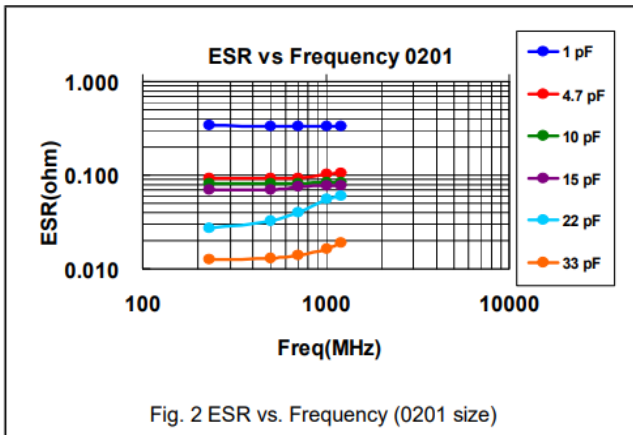

**MULTILAYER CERAMIC CHIP CAPACITORS RF SERIES**

**ELECTRICAL CHARACTERISTICS**

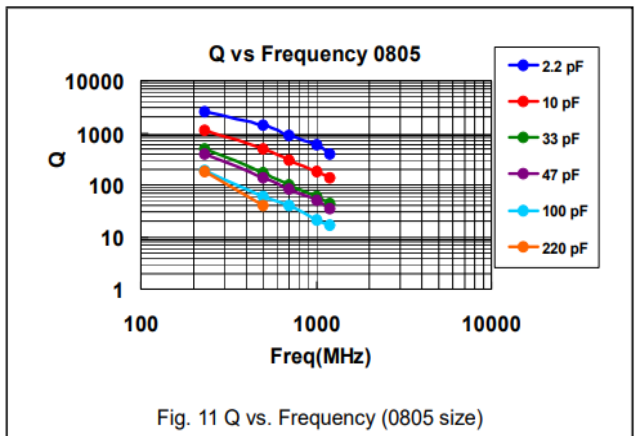
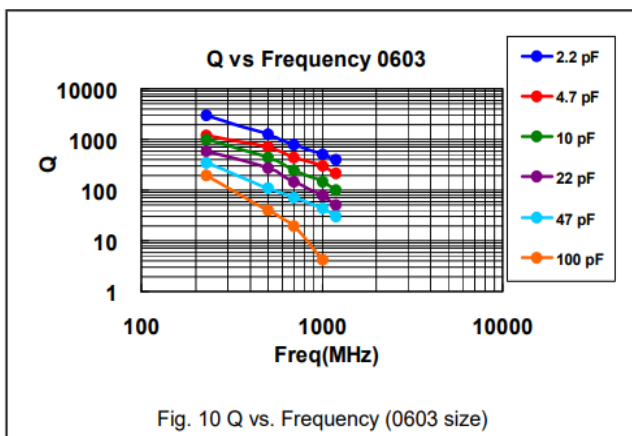
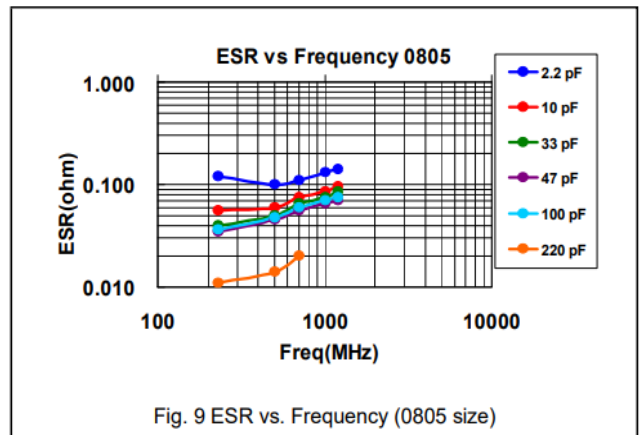
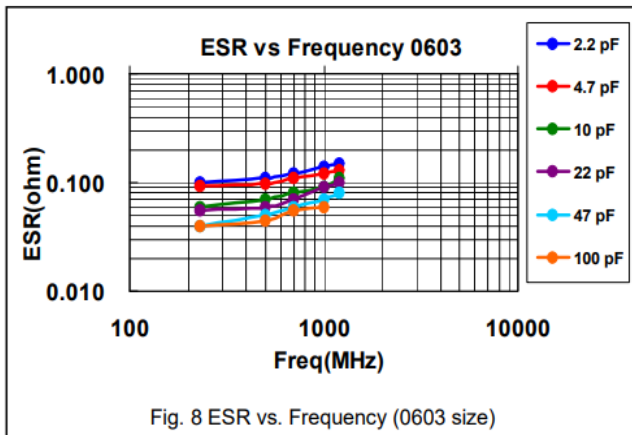
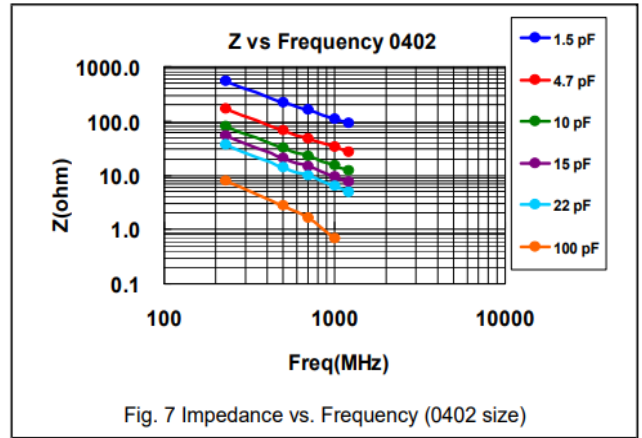
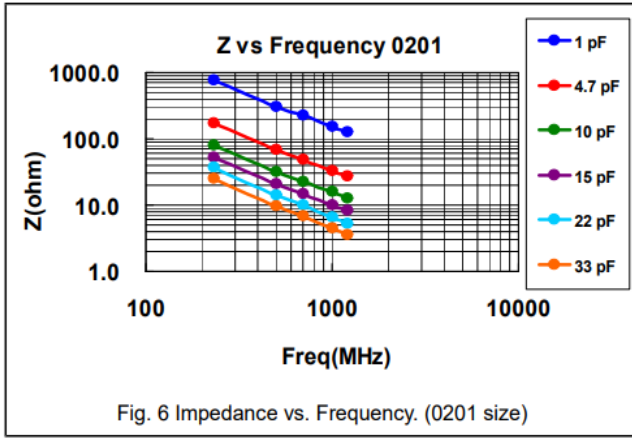

**MULTILAYER CERAMIC CHIP CAPACITORS RF SERIES**

**ELECTRICAL CHARACTERISTICS**

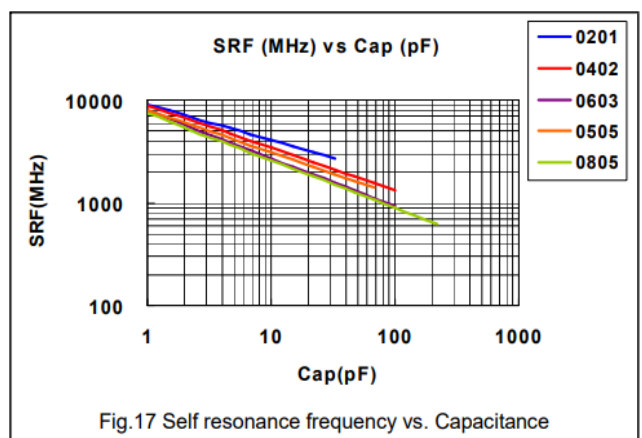
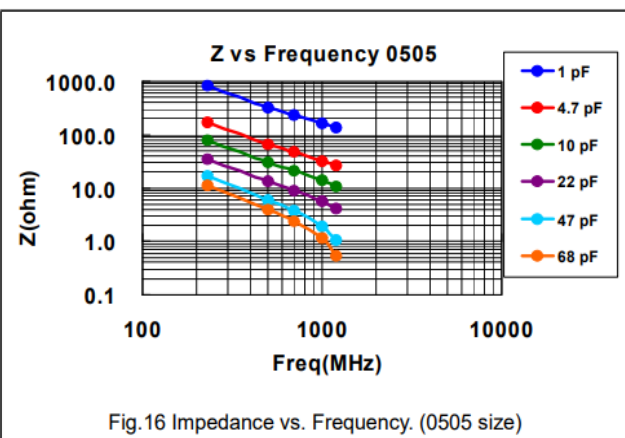
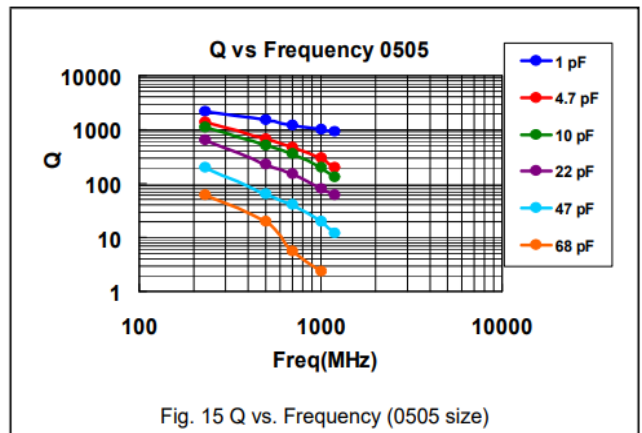
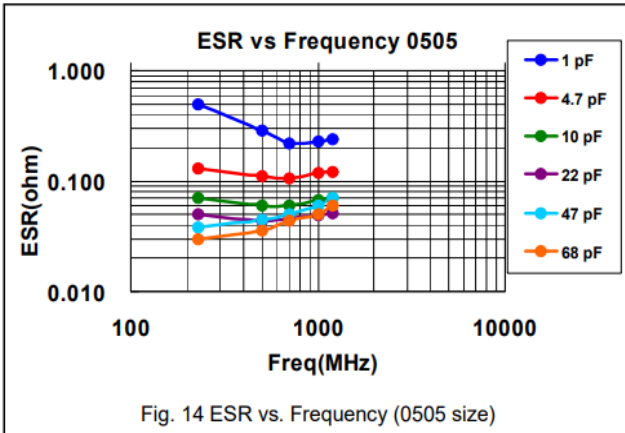
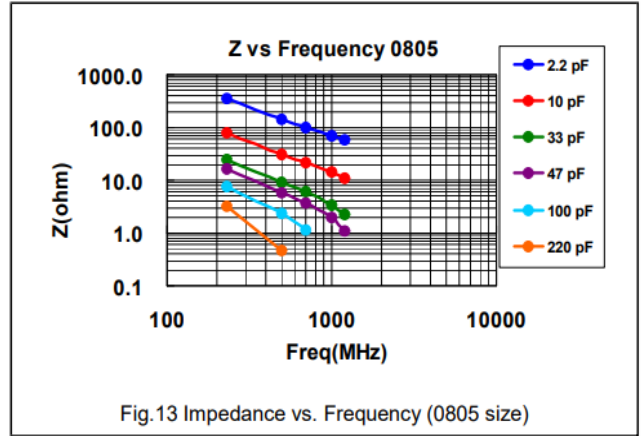
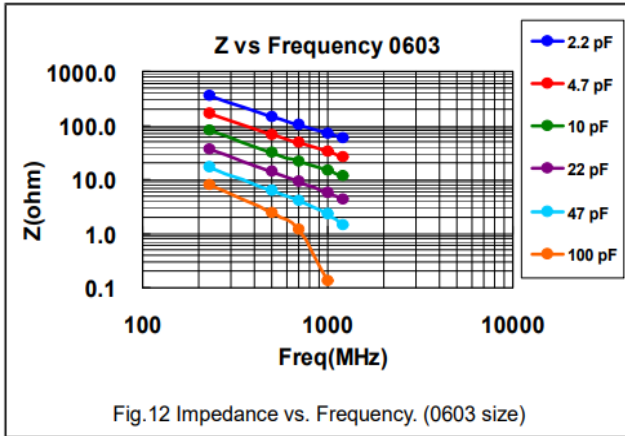



**MULTILAYER CERAMIC CHIP CAPACITORS RF SERIES**
**Temperature Cycle– Test Condition**
*Table 4*

Step	Temp. (°C)	Time (min.)
1	Min. operating temp. +0/-3	30±3
2	Room temp.	2~3
3	Max. operating temp. +3/-0	30±3
4	Room temp.	2~3

**ESR– Requirements**
*Table 5*

01005	0505
0.2pF≤Cap≤1pF:< 700mΩ/pF	0.4pF≤Cap<1.0pF: < 1500mΩ
1pF<Cap≤2pF:< 600mΩ	1.0pF≤Cap<10pF:< 250mΩ
2pF<Cap≤5pF:< 500mΩ	10pF≤Cap≤100pF: < 200mΩ
5pF<Cap≤10pF:< 300mΩ	
10pF<Cap≤22pF:< 350mΩ	

0201	0402
0.1pF≤Cap≤1pF:< 350mΩ/Pf	0.1pF≤Cap≤1pF:< 350mΩ/pF
1pF<Cap≤5pF:< 300mΩ	1pF<Cap≤5pF:< 300mΩ
5pF<Cap≤22pF:< 250mΩ	5pF<Cap≤100pF:< 250mΩ
22pF≤Cap≤33pF: < 300mΩ	

0603	0805
0.3pF≤Cap≤1pF:< 1500mΩ	0.3pF≤Cap≤1pF: < 1500mΩ
1pF<Cap≤10pF:< 250mΩ	1pF<Cap≤10pF: < 250mΩ
10pF<Cap≤100pF:< 200mΩ	Cap>10pF: < 200mΩ

**MULTILAYER CERAMIC CHIP CAPACITORS RF SERIES**
**RELIABILITY TEST CONDITIONS AND REQUIREMENTS**

Item	Test Conditions	Requirements
<b>Visual and Mechanical</b>	-----	<ul style="list-style-type: none"> <li>* No remarkable defect.</li> <li>* Dimensions to conform to individual specification sheet.</li> </ul>
<b>Capacitance</b>	1.0±0.2Vrms, 1MHz±10% At 25° C ambient temperature.	* Shall not exceed the limits given in the detailed spec.
<b>Q/ D.F. (Dissipation Factor)</b>		<ul style="list-style-type: none"> <li>* 01005, 0201, 0402/25V~50V: Cap&lt;30pF,Q≥400+20C;Cap≥30pF, Q≥1000</li> <li>* 0402/100V~200V, 0603, 0805, 0505, 1111: Cap&lt;30pF:Q≥800+20C;Cap≥30pF:Q≥1400</li> </ul>
<b>Dielectric Strength</b>	<ul style="list-style-type: none"> <li>*To apply voltage: ≤100V : 250% of rated voltage. 200V ~ 300V : 200% of rated voltage. 500V ~ 999V : 150% of rated voltage. 1000V ~ 3000V : 120% of rated voltage. 4000V : 110% of rated voltage.</li> <li>*Duration: 1 to 5 sec.</li> <li>*Charge &amp; discharge current less than 50mA.</li> </ul>	* No evidence of damage or flash over during test.
<b>Insulation Resistance</b>	<ul style="list-style-type: none"> <li>≤100V : To apply rated voltage for max. 120 sec.</li> <li>≥200V :To apply rated voltage (500V max.) for 60 sec.</li> </ul>	≥10GΩ or RxC≥100Ω-F whichever is smaller
<b>Temperature Coefficient</b>	<ul style="list-style-type: none"> <li>With no electrical load.</li> <li>Operating temperature: -55~125° C at 25° C</li> </ul>	*Capacitance change: within ±30ppm/° C; 0201Cap≥22pF, within ±60ppm/° C
<b>Temperature Cycle</b>	<ul style="list-style-type: none"> <li>*Conduct the five cycles according to the temperatures and time See &lt;Table 4&gt;</li> <li>* Cap. / DF(Q) / I.R. Measurement to be made after de-aging at 150° C for 1hr then set for 24±2 hrs at room temp.</li> </ul>	<ul style="list-style-type: none"> <li>* No remarkable damage.</li> <li>* Cap change: within ±2.5% or ±0.25pF whichever is larger. * Q/D.F., I.R. and dielectric strength: To meet initial requirements.</li> </ul>

**MULTILAYER CERAMIC CHIP CAPACITORS RF SERIES**
**RELIABILITY TEST CONDITIONS AND REQUIREMENTS**

Item	Test Conditions	Requirements
<b>Adhesive Strength of Termination</b>	*Pressurizing force: 01005: 1N 0201: 2N 0402 to 0603: 5N >0603: 10N * Test time: $10 \pm 1$ sec.	* No remarkable damage or removal of the terminations.
<b>Vibration Resistance</b>	* Vibration frequency: 10~55 Hz/min. * Total amplitude: 1.5mm * Test time: 6 hrs. (Two hrs each in three mutually perpendicular directions.) *Cap./DF(Q) Measurement to be made after de-aging at 150° C for 1hr then set for $24 \pm 2$ hrs at room temp.	*No remarkable damage. * Cap change and Q/D.F.: To meet initial spec.
<b>Solderability</b>	* Solder temperature: $235 \pm 5$ ° C * Dipping time: $2 \pm 0.5$ sec.	95% min. coverage of all metalized area.
<b>Bending Test</b>	*The middle part of substrate shall be pressurized by means of the pressurizing rod at a rate of about 1 mm per second until the deflection becomes 1 mm and then the pressure shall be maintained for $5 \pm 1$ sec. * Measurement to be made after keeping at room temp. for $24 \pm 2$ hrs.	*No remarkable damage. * Cap change: within $\pm 5.0\%$ or $\pm 0.5\text{pF}$ whichever is larger. (This capacitance change means the change of capacitance under specified flexure of substrate from the capacitance measured before the test.)
<b>Resistance to Soldering Heat</b>	* Solder temperature: $260 \pm 5$ ° C * Dipping time: $10 \pm 1$ sec *Preheating: 120 to 150° C for 1 minute before immerse the capacitor in a eutectic solder. *Cap. / DF(Q) / I.R. Measurement to be made after de-aging at 150° C for 1hr then set for $24 \pm 2$ hrs at room temp.	* No remarkable damage. *Cap change: within $\pm 2.5\%$ or $\pm 0.25\text{pF}$ whichever is larger. * Q/D.F., I.R. and dielectric strength: To meet initial requirements. * 25% max. leaching on each edge.

**MULTILAYER CERAMIC CHIP CAPACITORS RF SERIES**

**RELIABILITY TEST CONDITIONS AND REQUIREMENTS**

Item	Test Conditions	Requirements
<b>Humidity (Damp Heat) Steady State</b>	<ul style="list-style-type: none"> <li>*Test temp.: <math>40 \pm 2^{\circ}</math> C</li> <li>* Humidity: 90~95% RH</li> <li>* Test time: 500+24/-0hrs.</li> <li>* Cap. / DF(Q) / I.R. Measurement to be made after de-aging at <math>150^{\circ}</math> C for 1hr then set for <math>24 \pm 2</math> hrs at room temp.</li> </ul>	<ul style="list-style-type: none"> <li>* No remarkable damage.</li> <li>* Cap change: within <math>\pm 5.0\%</math> or <math>\pm 0.5\text{pF}</math> whichever is larger.</li> <li>*Q/D.F. value: Cap<math>\geq 30\text{pF}</math>, Q<math>\geq 350</math>; 10pF<math>\leq</math>Cap<math>&lt; 30\text{pF}</math>, Q<math>\geq 275+2.5C</math> Cap<math>&lt; 10\text{pF}</math>, Q<math>\geq 200+10C</math></li> <li>* I.R.: <math>\geq 1G\Omega</math>.</li> </ul>
<b>Humidity (Damp Heat) Load</b>	<ul style="list-style-type: none"> <li>*Test temp.: <math>40 \pm 2^{\circ}</math> C</li> <li>* Humidity: 90~95%RH</li> <li>* Test time: 500+24/-0 hrs.</li> <li>*To apply voltage: rated voltage (MAX. 500V)</li> <li>* Cap. / DF(Q) / I.R. Measurement to be made after de-aging at <math>150^{\circ}</math> C for 1hr then set for <math>24 \pm 2</math> hrs at room temp.</li> </ul>	<ul style="list-style-type: none"> <li>* No remarkable damage.</li> <li>* Cap change: within <math>\pm 7.5\%</math> or <math>\pm 0.75\text{pF}</math> whichever is larger.</li> <li>*Q/D.F. value: Cap<math>\geq 30\text{pF}</math>, Q<math>\geq 200</math>; Cap<math>&lt; 30\text{pF}</math>, Cap<math>\geq 100+10/3C</math></li> <li>* I.R.: <math>\geq 500M\Omega</math>.</li> </ul>
<b>High Temperature Load (Endurance)</b>	<ul style="list-style-type: none"> <li>* Test temp.: <math>125 \pm 3^{\circ}</math> C</li> <li>* To apply voltage:               <ul style="list-style-type: none"> <li>(1) <math>10V \leq U_r &lt; 500V</math>: 200% of rated voltage.</li> <li>(2) <math>\leq 6.3V</math> or <math>500V</math>: 150% of rated voltage.</li> <li>(3) <math>U_r \geq 630V</math>: 120% of rated voltage.</li> </ul> </li> <li>* Test time: 1000+24/-0 hrs.</li> <li>* Cap. / DF(Q) / I.R. Measurement to be made after de-aging at <math>150^{\circ}</math> C for 1hr then set for <math>24 \pm 2</math> hrs at room temp</li> </ul>	<ul style="list-style-type: none"> <li>* No remarkable damage.</li> <li>* Cap change: within <math>\pm 3.0\%</math> or <math>\pm 0.3\text{pF}</math> whichever is larger.</li> <li>* Q/D.F. value: Cap<math>\geq 30\text{pF}</math>, Q<math>\geq 350</math> 10pF<math>\leq</math>Cap<math>&lt; 30\text{pF}</math>, Q<math>\geq 275+2.5C</math> Cap<math>&lt; 10\text{pF}</math>, Q<math>\geq 200+10C</math></li> <li>* I.R.: <math>\geq 1G\Omega</math>.</li> </ul>
<b>ESR</b>	<p>The ESR should be measured at room temperature and tested at frequency <math>1 \pm 0.1</math> GHz.</p> <p>The ESR should be measured at room temperature and tested at frequency <math>500 \pm 50</math> MHz.</p>	See <Table 5>

## MULTILAYER CERAMIC CHIP CAPACITORS RF SERIES

### RECOMMENDED PROFILE CONDITIONS

The lead-free termination MLCCs are not only to be used on SMT against lead-free solder paste, but also suitable against lead-containing solder paste.

If the optimized solder joint is requested, increasing soldering time, temperature and concentration of N2 within oven are recommended.

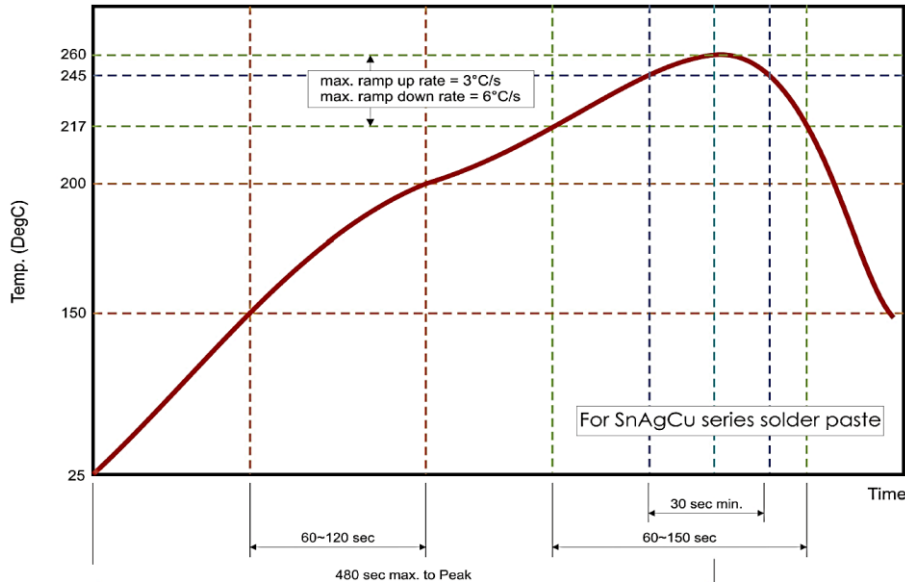

Reflow Soldering Profile For SMT Process with SnAgCu series Solder Paste

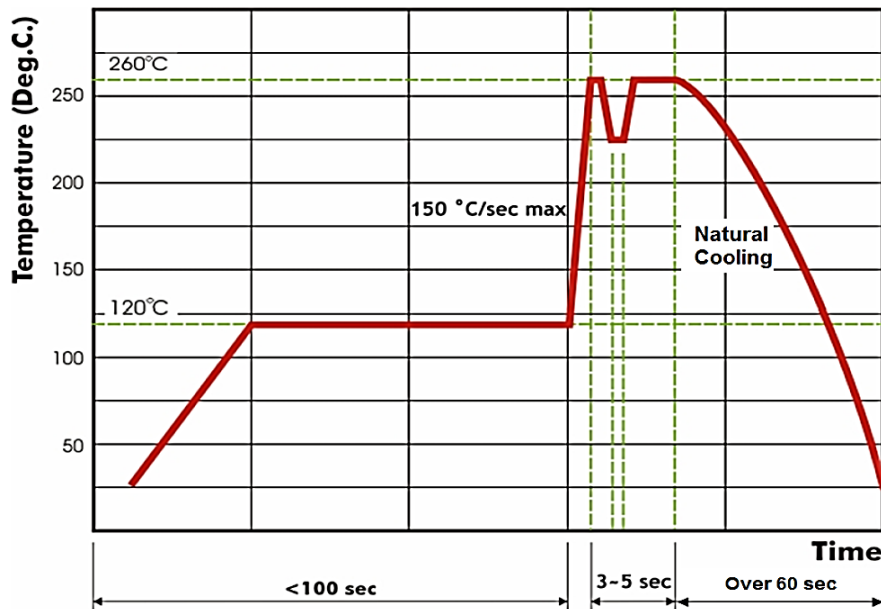

Wave Soldering Profile For SMT Process with SnAgCu series Solder Paste

**MULTILAYER CERAMIC CHIP CAPACITORS RF SERIES**

**REEL DIMENSION (Unit: mm)**

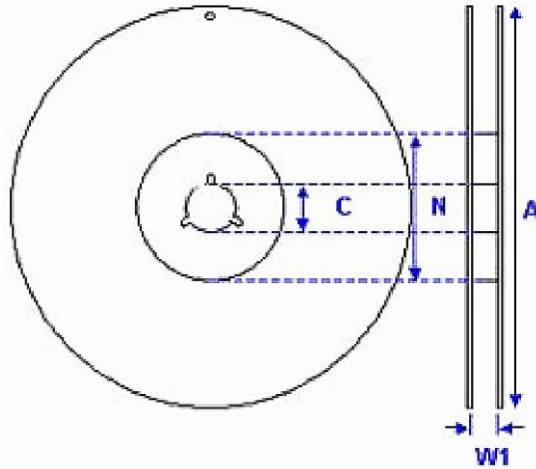

Size Code	01005, 0201, 0402, 0505, 0603, 0805, 1111	
Reel Size	7"	13"
C	13.0+0.5/-0.2	13.0+0.5/-0.2
W 1	8.4+1.5/0	8.4+1.5/0
A	178.0±0.10	330.0±1.0
N	60.0+1.0/-0	100±1.0

**TAPE DIMENSION (Unit: mm)**

Paper Tape

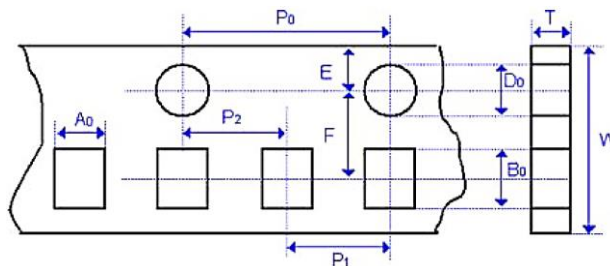

Plastic Tape

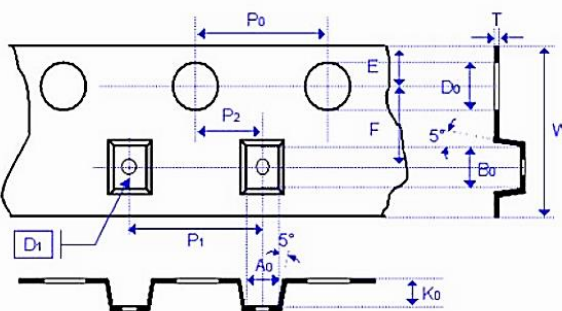

**MULTILAYER CERAMIC CHIP CAPACITORS RF SERIES**
**TAPE DIMENSION (Unit: mm)**

Size	01005	0201	0402	0505	0603	0805	1111
Thickness	V	L	N	J	S	T	G
A0	0.25 +/-0.05	0.40 +/-0.07	0.70 +/-0.2	<1.90	1.05 +/-0.30	1.50 +/-0.20	< 3.05
B0	0.45 +/-0.05	0.70 +/-0.07	1.20 +/-0.2	<1.90	1.80 +/-0.30	2.30 +/-0.20	< 3.80
T	≤0.50	≤0.55	≤0.80	0.23 ± 0.10	≤1.20	≤1.20	0.23 +/-0.1
K0	-	-	-	<1.50	-	-	< 2.50
W	8.00 +/-0.10	8.00 +/-0.10	8.00 +/-0.10	8.00 +/-0.20	8.00 +/-0.10	8.00 +/-0.10	8.00 +/-0.20
P0	4.00 +/-0.10	4.00 +/-0.10	4.00 +/-0.10	4.00 +/-0.10	4.00 +/-0.10	4.00 +/-0.10	4.00 +/-0.10
10xP0	40.00 +/-0.10	40.00 +/-0.10	40.00 +/-0.10	40.00 +/-0.20	40.00 +/-0.20	40.00 +/-0.20	40.00 +/-0.20
P1	2.00 +/-0.05	2.00 +/-0.05	2.00 +/-0.05	4.00 +/-0.10	4.00 +/-0.10	4.00 +/-0.10	4.00 +/-0.10
P2	2.00 +/-0.05	2.00 +/-0.05	2.00 +/-0.05	2.00 +/-0.05	2.00 +/-0.05	2.00 +/-0.05	2.00 +/-0.05
D0	1.55 +/-0.05	1.55 +/-0.05	1.55 +/-0.05	1.55 +/-0.05	1.55 +/-0.05	1.55 +/-0.05	1.55 +1/-0
D1	-	-	-	1.00 ± 0.10	-	-	1.00 ± 0.10
E	1.75 +/-0.05	1.75 +/-0.05	1.75 +/-0.05	1.75 +/-0.05	1.75 +/-0.05	1.75 +/-0.05	1.75 +/-0.10
F	3.50 +/-0.05	3.50 +/-0.05	3.50 +/-0.05	3.50 +/-0.05	3.50 +/-0.05	3.50 +/-0.05	3.50 +/-0.05

## MULTILAYER CERAMIC CHIP CAPACITORS RF SERIES

### STORAGE AND HANDLING CONDITIONS

- (1) To store products at 5 to 40°C ambient temperature and 20 to 70% related humidity conditions.
- (2) The product is recommended to be used within one year after shipment. Check solder ability in case of shelf life extension is needed.

### CAUTIONS

- (1) The corrosive gas reacts on the terminal electrodes of capacitors, and results in the poor solder ability. Do not store the capacitors in the ambience of corrosive gas (e.g., hydrogen sulfide, sulfur dioxide, chlorine, ammonia gas etc.)
- (2) In corrosive atmosphere, solder ability might be degraded, and silver migration might occur to cause low reliability.
- (3) Due to the dewing by rapid humidity change, or the photochemical change of the terminal electrode by direct sun light, the solder ability and electrical performance may deteriorate. Do not store capacitors under direct sunlight or dewing condition. To store products on the shelf and avoid exposure to moisture.

### DISCLAIMER

NextGen Component, Inc. reserves the right to make changes to the product(s) and or information contained herein without notice. No liability is assumed as a result of their use or application. No rights under any patent accompany the sale of any such product(s) or information