



SPECIFICATION SHEET

SPECIFICATION SHEET NO.	Q1011- SH06B105K250JC	
DATE	Oct. 11, 2023	
REVISION	A0	Updated With Most Recent Data
DESCRIPTION AND MAIN PARAMETRICS	<p>Multilayer Ceramic Chip Capacitors SH1206 (3216 Metric) Series, L3.20*W1.60*H1.15mm, Thickness: 1.30mm Max.</p> <p>Dielectric X7R, Capacitance 1.0μF, Tolerance ±10%, Rated Voltage 25V</p> <p>Operating Temp. Range -55°C ~+125°C</p> <p>Package in Tape/Reel, 3,000pcs/Reel</p> <p>RoHS/RoHS III compliant</p>	
CUSTOMER		
CUSTOMER PART NO.		
CROSS REF. PART NO.		
ORIGINAL MFG/PART NO.	Aillen/SH1206B105K250JC	
PART CODE	SH06B105K250JC	

VENDOR APPROVE			
Issued/Checked/Approved			
DATE: Oct. 11, 2023			

CUSTOMER APPROVE	
DATE:	

MULTILAYER CERAMIC CHIP CAPACITORS SH SERIES

INTRODUCTION

Soft termination series MLCC is designed and with a polymer layer within end terminations of product, which can absorb mechanical stress caused by PCB handling in SMT line and reduce the mechanical impact for product. It will offer more robust and reliable performance in applications.

MAIN FEATURE

- RoHS III Compliant
- MLCC's termination are with a soft & flexible polymer layer to withstand high bending stress in SMT line
- Available for any item in standard series range.

APPLICATION

- Automotive industry.
- Power supply and related industries.
- Lighting industry.
- The other mechanical stress concerned products.

HOW TO ORDER

Please contact us by e-mail sales@NextGenComponents.com and indicate **Part code** or custom your requirement for your Application.

MULTILAYER CERAMIC CHIP CAPACITORS SH SERIES
PART CODE GUIDE
[**RFQ**](#)
[Request For Quotation](#)

Code	Name	Key Specification Option
SH	Product Code	SH is for Soft termination
06	Size	02: 0402 (1005): L1.00*W0.50mm; 03: 0603 (1608): L1.60*W0.80mm; 05: 0805 (2012): L2.00*W1.25mm; 06: 1206 (3216): L3.20*W1.60mm; 10: 1210 (3225): L3.20*W2.50mm; 08: 1808 (4520): L4.50*W2.03mm; 12: 1812 (4532): L4.50*W3.20mm; 25:1825 (4563):L4.50*W6.30mm 20: 2220 (5750): L5.70*W5.00mm; 22: 2225 (5763): L5.70*W6.30mm
B	Dielectric	N: NP0 (C0G); B: X7R ; F: Y5V; X: X5R;
105	Capacitance	Two significant digits followed by number of Zero, The 3rd digit signifies the multiplying factor, and letter R is decimal point. For example: 101: 100pF; 100: 10pF; 105: 1.0μF
K	Tolerance	B=±0.1pF; C=±0.25pF; D=±0.5pF; F=±1%; G=±2%; J=±5%; K=±10% ; M=±20%; Z=-20/+80%
250	Rated Voltage	Two significant digits followed by No. of zeros. "R" is in place of decimal point. 6R3=6.3 VDC; 100=10 VDC; 160=16 VDC; 250=25 VDC ; 500=50 VDC; 101 =100 VDC; 201=200 VDC; 251=250 VDC;401: 400 VDC; 451: 450 VDC; 501=500 VDC; 631=630 VDC; 102 =1000 VDC; 152: 1500 VDC; 202: 2000 VDC; 252: 2500 VDC; 302: 3000 VDC
J	Thickness	J: 1.15 ± 0.15mm, See Table 1
C	Package	K: 0.5 Kpcs/Reel; A: 1Kpcs/Reel; B: 2Kpcs/Reel; C: 3Kpcs/Reel ; D: 4Kpcs/Reel; E: 15Kpcs/Reel; I: 10Kpcs/Reel; J: 2.5Kpcs/Reel; F: others
	Internal Control	Internal Code: Letter + Number; Blank: N/A;

MULTILAYER CERAMIC CHIP CAPACITORS SH SERIES

DIMENSION (Unit: mm)

Image for reference

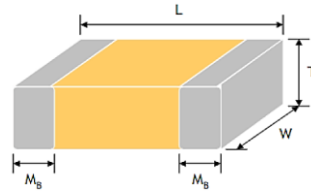

Table 1

Size Code	L	W	T (Symbol)	Remark	M B
0402 (1005)	1.00±0.20	0.50±0.20	0.50±0.20 (E)	#	0.25+0.05/-0.10
0603 (1608)	1.60±0.20	0.80±0.10	0.80±0.07 (S)		0.40±0.15
	1.60±0.30	0.80±0.30	0.80±0.30 (X)		
0805 (2012)	2.00±0.20	1.25±0.10	0.60±0.10 (A); 0.80±0.10 (B);		0.50±0.20
	2.00±0.20	1.25±0.10	1.25±0.10 (D)	#	
	2.00±0.30	1.25±0.30	1.25±0.30 (I)	#	
1206 (3216)	3.20+0.4/-0.1	1.60±0.15	0.80±0.10 (B);		0.60±0.20 (0.50±0.25)*
	3.20+0.4/-0.1	1.60±0.15	0.95±0.10 (C); 1.15±0.15 (J); 1.25±0.10 (D);	#	
	3.20+0.4/-0.1	1.60±0.20	1.60±0.20 (G)	#	
	3.20±0.50	1.60±0.50	1.60±0.50 (P)	#	
1210 (3225)	3.20±0.40	2.50±0.20	0.95±0.10 (C) ; 1.25±0.10 (D);	#	0.75±0.25
	3.20±0.60	2.50±0.50	1.60±0.20 (G) ; 2.00±0.20 (K); 2.50±0.50 (M) ;	#	
1808 (4520)	4.50+0.6/-0.4	2.03±0.25	1.25±0.10 (D); 2.00±0.20 (K);	#	0.50±0.25
1812 (4532)	4.50+0.6/-0.4	3.20±0.30	1.25±0.10 (D); 1.60±0.20 (G) 2.00±0.20 (K);	#	0.75±0.25 (0.50±0.25)*
		3.20±0.40	2.50±0.50 (M)	#	
1825 (4532)	4.50+0.6/-0.4	6.30±0.40	2.00±0.20 (K); 2.50±0.50 (M)	#	0.75±0.35
2220 (5750)	5.70±0.50	5.00±0.40	2.80±0.30 (U)		0.85±0.35
2225 (5763)	5.70±0.50	6.30±0.40			0.85±0.35

Note: 1) # Reflow soldering only is recommended. 2) * For 1206≥1000V, 1812_200V~4000V products.

MULTILAYER CERAMIC CHIP CAPACITORS SH SERIES
GENERAL ELECTRONICAL CHARACTERISTICS
Table 2

Dielectric	NP0	X7R	X5R	Y5V
Size	0402, 0603, 0805, 1206, 1210, 1808, 1812, 1825, 2220, 2225			
Capacitance range (Note 1)	0.1pF to 0.1μF	100pF to 47μF	0.033μF to 10μF	0.01μF to 2.2μF
Capacitance Tolerance	Cap. ≤5pF: B (±0.1pF), C (±0.25pF) 5pF < Cap < 10pF: C (±0.25pF), D (±0.5pF) Cap ≥ 10pF: F (±1%), G (±2%), J (±5%), K (±10%)	K (±10%), M (±20%)	K (±10%), M (±20%)	Z (-20/+80%)
Rated Voltage	6.3V to 3000V			
Operating Temperature	-55 ~ +125°C		-55 ~ +85°C	-25 ~ +85°C
Capacitance Characteristic	±30ppm	±15%	±15%	+30/-80%
Termination	Ni/Sn (lead-free termination)			

Note:

1. Measured at the condition of 30~70% related humidity.
2. NP0: Apply $1.0 \pm 0.2V_{rms}$, $1.0MHz \pm 10\%$ for $Cap \leq 1000pF$ and $1.0 \pm 0.2V_{rms}$, $1.0kHz \pm 10\%$ for $Cap > 1000pF$, 25°C at ambient temperature. X7R, X5R: Apply $1.0 \pm 0.2V_{rms}$, $1.0kHz \pm 10\%$, at 25° C ambient temperature. Y5V: Apply $1.0 \pm 0.2V_{rms}$, $1.0kHz \pm 10\%$, at 20°C ambient temperature.
3. Preconditioning for Class II MLCC: Perform a heat treatment at $150 \pm 10^\circ C$ for 1 hour and then leave in ambient condition for 24 ± 2 hours before measurement.

MULTILAYER CERAMIC CHIP CAPACITORS SH SERIES

CAPACITANCE RANGE - NPO DIELECTRIC 0402, 0603 SIZES

Table 3-A

Size	0402					0603							
	VDC (V)	10	16	25	50	100	10	16	25	50	100	200	250
0.1pF (0R1)	E	E	E	E									
0.2pF (0R2)	E	E	E	E									
0.3pF (0R3)	E	E	E	E		S	S	S	S				
0.4pF (0R4)	E	E	E	E		S	S	S	S				
0.5pF (0R5)	E	E	E	E	E	S	S	S	S	S	S	S	S
0.6pF (0R6)	E	E	E	E	E	S	S	S	S	S	S	S	S
0.7pF (0R7)	E	E	E	E	E	S	S	S	S	S	S	S	S
0.8pF (0R8)	E	E	E	E	E	S	S	S	S	S	S	S	S
0.9pF (0R9)	E	E	E	E	E	S	S	S	S	S	S	S	S
1.0pF (1R0)	E	E	E	E	E	S	S	S	S	S	S	S	S
1.2pF (1R2)	E	E	E	E	E	S	S	S	S	S	S	S	S
1.5pF (1R5)	E	E	E	E	E	S	S	S	S	S	S	S	S
1.8pF (1R8)	E	E	E	E	E	S	S	S	S	S	S	S	S
2.2pF (2R2)	E	E	E	E	E	S	S	S	S	S	S	S	S
2.7pF (2R7)	E	E	E	E	E	S	S	S	S	S	S	S	S
3.3pF (3R3)	E	E	E	E	E	S	S	S	S	S	S	S	S
3.9pF (3R9)	E	E	E	E	E	S	S	S	S	S	S	S	S
4.7pF (4R7)	E	E	E	E	E	S	S	S	S	S	S	S	S
5.6pF (5R6)	E	E	E	E	E	S	S	S	S	S	S	S	S
6.8pF (6R8)	E	E	E	E	E	S	S	S	S	S	S	S	S
8.2pF (8R2)	E	E	E	E	E	S	S	S	S	S	S	S	S
10pF (100)	E	E	E	E	E	S	S	S	S	S	S	S	S
12pF (120)	E	E	E	E	E	S	S	S	S	S	S	S	S
15pF (150)	E	E	E	E	E	S	S	S	S	S	S	S	S
18pF (180)	E	E	E	E	E	S	S	S	S	S	S	S	S
22pF (220)	E	E	E	E	E	S	S	S	S	S	S	S	S
27pF (270)	E	E	E	E	E	S	S	S	S	S	S	S	S
33pF (330)	E	E	E	E	E	S	S	S	S	S	S	S	S
39pF (390)	E	E	E	E	E	S	S	S	S	S	S	S	S
47pF (470)	E	E	E	E	E	S	S	S	S	S	S	S	S
56pF (560)	E	E	E	E	E	S	S	S	S	S	S	S	S
68pF (680)	E	E	E	E	E	S	S	S	S	S	S	S	S
82pF (820)	E	E	E	E	E	S	S	S	S	S	S	S	S
100pF (101)	E	E	E	E	E	S	S	S	S	S	S	S	S
120pF (121)	E	E	E	E	E	S	S	S	S	S	S	S	S

MULTILAYER CERAMIC CHIP CAPACITORS SH SERIES

CAPACITANCE RANGE - NPO DIELECTRIC 0402, 0603 SIZES

Table 3-B

Size	0402					0603							
	VDC (V)	10	16	25	50	100	10	16	25	50	100	200	250
150pF (151)	E	E	E	E	E	S	S	S	S	S	S	S	S
180pF (181)	E	E	E	E	E	S	S	S	S	S	S	S	S
220pF (221)	E	E	E	E	E	S	S	S	S	S	S	S	S
270pF (271)	E	E	E	E		S	S	S	S	S	X	X	
330pF (331)	E	E	E	E		S	S	S	S	S	X	X	
390pF (391)	E	E	E	E		S	S	S	S	S	X	X	
470pF (471)	E	E	E	E		S	S	S	S	S	X	X	
560pF (561)	E	E	E	E		S	S	S	S	S			
680pF (681)	E	E	E	E		S	S	S	S	S			
820pF (821)	E	E	E	E		S	S	S	S	S			
1,000pF (102)	E	E	E	E		S	S	S	S	S			
1,200pF (122)						X	X	X	X				
1,500pF (152)						X	X	X	X				
1,800pF (182)						X	X	X	X				
2,200pF (222)						X	X	X	X				
2,700pF (272)						X	X	X	X				
3,300pF (332)						X	X	X	X				

CAPACITANCE RANGE - NPO DIELECTRIC 0805 SIZES

Table 3-C

Size	0805										
	VDC (V)	10	16	25	50	100	200	250	500	630	1000
0.5pF (0R5)	A	A	A	A	A	A	A	A	A	A	D
0.6pF (0R6)	A	A	A	A	A	A	A	A	A	A	D
0.7pF (0R7)	A	A	A	A	A	A	A	A	A	A	D
0.8pF (0R8)	A	A	A	A	A	A	A	A	A	A	D
0.9pF (0R9)	A	A	A	A	A	A	A	A	A	A	D
1.0pF (1R0)	A	A	A	A	A	A	A	A	A	A	D
1.2pF (1R2)	A	A	A	A	A	A	A	A	A	A	D
1.5pF (1R5)	A	A	A	A	A	A	A	A	A	A	D
1.8pF (1R8)	A	A	A	A	A	A	A	A	A	A	D
2.2pF (2R2)	A	A	A	A	A	A	A	A	A	A	D
2.7pF (2R7)	A	A	A	A	A	A	A	A	A	A	D
3.3pF (3R3)	A	A	A	A	A	A	A	A	A	A	D
3.9pF (3R9)	A	A	A	A	A	A	A	A	A	A	D

MULTILAYER CERAMIC CHIP CAPACITORS SH SERIES

CAPACITANCE RANGE - NP0 DIELECTRIC 0805 SIZES

Table 3-D

Size	0805									
VDC (V)	10	16	25	50	100	200	250	500	630	1000
4.7pF (4R7)	A	A	A	A	A	A	A	A	A	D
5.6pF (5R6)	A	A	A	A	A	A	A	A	A	D
6.8pF (6R8)	A	A	A	A	A	A	A	A	A	D
8.2pF (8R2)	A	A	A	A	A	A	A	A	A	D
10pF (100)	A	A	A	A	A	A	A	A	A	D
12pF (120)	A	A	A	A	A	A	A	A	A	D
15pF (150)	A	A	A	A	A	A	A	A	A	D
18pF (180)	A	A	A	A	A	A	A	A	A	D
22pF (220)	A	A	A	A	A	A	A	A	A	D
27pF (270)	A	A	A	A	A	A	A	A	A	D
33pF (330)	A	A	A	A	A	A	A	A	A	D
39pF (390)	A	A	A	A	A	A	A	A	A	D
47pF (470)	A	A	A	A	A	A	A	A	A	D
56pF (560)	A	A	A	A	A	A	A	A	A	D
68pF (680)	A	A	A	A	A	A	A	A	A	D
82pF (820)	A	A	A	A	A	A	A	B	B	D
100pF (101)	A	A	A	A	A	A	B	B	B	D
120pF (121)	A	A	A	A	A	A	B	D	D	D
150pF (151)	A	A	A	A	A	B	D	D	D	D
180pF (181)	A	A	A	A	A	B	D	D	D	D
220pF (221)	A	A	A	A	A	D	D	D	D	D
270pF (271)	A	A	A	A	A	D	D	D	D	D
330pF (331)	A	A	A	A	A	D	D	D	D	D
390pF (391)	B	B	B	B	B	D	D	D	D	D
470pF (471)	B	B	B	B	B	D	D	I	I	
560pF (561)	B	B	B	B	B	D	D	I	I	
680pF (681)	B	B	B	B	B	D	D	I	I	
820pF (821)	B	B	B	B	B	D	D	I	I	
1,000pF (102)	B	B	B	B	B	D	D	I	I	
1,200pF (122)	B	B	B	B	B	D	D			
1,500pF (152)	B	B	B	B	B	D	D			
1,800pF (182)	B	B	B	B	B	D	D			
2,200pF (222)	B	B	B	B	B	D	D			

MULTILAYER CERAMIC CHIP CAPACITORS SH SERIES

CAPACITANCE RANGE - NPO DIELECTRIC 0805 SIZES

Table 3-E

Size	0805									
VDC (V)	10	16	25	50	100	200	250	500	630	1000
2,700pF (272)	D	D	D	D	D					
3,300pF (332)	D	D	D	D	D					
3,900pF (392)	D	D	D	D	D					
4,700pF (472)	D	D	D	D	D					
5,600pF (562)	D	D	D	D	D					
6,800pF (682)	D	D	D	D	D					
8,200pF (822)	D	D	D	D						
0.010μF (103)	D	D	D	D						

CAPACITANCE RANGE - NPO DIELECTRIC 1206 SIZES

Table 3-F

Size	1206											
VDC (V)	10	16	25	50	100	200	250	500	630	1000	1500	2000
1.2pF (1R2)	B	B	B	B	B							
1.5pF (1R5)	B	B	B	B	B	B	B	B	B	B	B	B
1.8pF (1R8)	B	B	B	B	B	B	B	B	B	B	B	B
2.2pF (2R2)	B	B	B	B	B	B	B	B	B	B	B	B
2.7pF (2R7)	B	B	B	B	B	B	B	B	B	B	B	B
3.3pF (3R3)	B	B	B	B	B	B	B	B	B	B	B	B
3.9pF (3R9)	B	B	B	B	B	B	B	B	B	B	B	B
4.7pF (4R7)	B	B	B	B	B	B	B	B	B	B	B	B
5.6pF (5R6)	B	B	B	B	B	B	B	B	B	B	B	B
6.8pF (6R8)	B	B	B	B	B	B	B	B	B	B	B	B
8.2pF (8R2)	B	B	B	B	B	B	B	B	B	B	B	B
10pF (100)	B	B	B	B	B	B	B	B	B	B	B	B
12pF (120)	B	B	B	B	B	B	B	B	B	B	B	B
15pF (150)	B	B	B	B	B	B	B	B	B	B	B	B
18pF (180)	B	B	B	B	B	B	B	B	B	B	B	B
22pF (220)	B	B	B	B	B	B	B	B	B	B	B	B
27pF (270)	B	B	B	B	B	B	B	B	B	B	B	B
33pF (330)	B	B	B	B	B	B	B	B	B	B	C	C
39pF (390)	B	B	B	B	B	B	B	B	B	B	C	C

MULTILAYER CERAMIC CHIP CAPACITORS SH SERIES

CAPACITANCE RANGE - NPO DIELECTRIC 1206 SIZES

Table 3-G

Size	1206											
VDC (V)	10	16	25	50	100	200	250	500	630	1000	1500	2000
47pF (470)	B	B	B	B	B	B	B	B	B	C	C	C
56pF (560)	B	B	B	B	B	B	B	B	B	C	D	D
68pF (680)	B	B	B	B	B	B	B	B	B	C	D	D
82pF (820)	B	B	B	B	B	B	B	B	B	D	D	D
100pF (101)	B	B	B	B	B	B	B	B	B	D	D	D
120pF (121)	B	B	B	B	B	B	B	B	B	D	G	G
150pF (151)	B	B	B	B	B	B	B	B	B	D	G	G
180pF (181)	B	B	B	B	B	B	B	B	B	G	G	G
220pF (221)	B	B	B	B	B	B	B	B	B	G	G	G
270pF (271)	B	B	B	B	B	B	C	C	C	G	P	P
330pF (331)	B	B	B	B	B	B	C	C	C	G	P	P
390pF (391)	B	B	B	B	B	B	C	C	C	G	P	P
470pF (471)	B	B	B	B	B	C	C	C	C	G		
560pF (561)	B	B	B	B	B	C	D	D	D	G		
680pF (681)	B	B	B	B	B	C	D	D	D	G		
820pF (821)	B	B	B	B	B	C	G	G	G	G		
1,000pF (102)	B	B	B	B	B	C	G	G	G	G		
1,200pF (122)	B	B	B	B	B	C	G	G	G			
1,500pF (152)	B	B	B	B	B	D	G	G	G			
1,800pF (182)	B	B	B	B	B	D	G	G	G			
2,200pF (222)	B	B	B	B	B	D	G	G	G			
2,700pF (272)	B	B	B	B	B	D	G	G	G			
3,300pF (332)	B	B	B	B	B	D	G	G	G			
3,900pF (392)	B	B	B	B	B	D	G	G	G			
4,700pF (472)	B	B	B	B	B	D	G	G	G			
5,600pF (562)	B	B	B	B	B							
6,800pF (682)	C	C	C	C	C							
8,200pF (822)	D	D	D	D	D							
0.010μF (103)	D	D	D	D	D							
0.012μF (123)	P	P	P	P	P							

MULTILAYER CERAMIC CHIP CAPACITORS SH SERIES

CAPACITANCE RANGE - NPO DIELECTRIC 1206 SIZES

Table 3-H

Size	1206											
VDC (V)	10	16	25	50	100	200	250	500	630	1000	1500	2000
0.015μF (153)	P	P	P	P	P							
0.018μF (183)	P	P	P	P	P							
0.022μF (223)	P	P	P	P	P							
0.027μF (273)	P	P	P	P								
0.033μF (333)	P	P	P	P								
0.039μF (393)	P	P	P	P								

CAPACITANCE RANGE - NPO DIELECTRIC 1210 SIZES

Table 3-I

Size	1210											
VDC (V)	10	16	25	50	100	200	250	500	630	1000	1500	2000
10pF (100)	C	C	C	C	C	C	C	C	C	C	C	C
12pF (120)	C	C	C	C	C	C	C	C	C	C	C	C
15pF (150)	C	C	C	C	C	C	C	C	C	C	C	C
18pF (180)	C	C	C	C	C	C	C	C	C	C	C	C
22pF (220)	C	C	C	C	C	C	C	C	C	C	C	C
27pF (270)	C	C	C	C	C	C	C	C	C	C	C	C
33pF (330)	C	C	C	C	C	C	C	C	C	C	C	C
39pF (390)	C	C	C	C	C	C	C	C	C	C	C	C
47pF (470)	C	C	C	C	C	C	C	C	C	C	C	C
56pF (560)	C	C	C	C	C	C	C	C	C	C	D	D
68pF (680)	C	C	C	C	C	C	C	C	C	C	D	D
82pF (820)	C	C	C	C	C	C	C	C	C	C	D	D
100pF (101)	C	C	C	C	C	C	C	C	C	D	D	D
120pF (121)	C	C	C	C	C	C	C	C	C	D	D	D
150pF (151)	C	C	C	C	C	C	C	C	C	D	G	G
180pF (181)	C	C	C	C	C	C	C	C	C	D	G	G
220pF (221)	C	C	C	C	C	C	C	C	C	G	G	G
270pF (271)	C	C	C	C	C	C	C	C	C	G	K	K
330pF (331)	C	C	C	C	C	C	C	C	C	G	K	K
390pF (391)	C	C	C	C	C	C	C	C	C	G	M	M

MULTILAYER CERAMIC CHIP CAPACITORS SH SERIES
CAPACITANCE RANGE - NPO DIELECTRIC 1210 SIZES
Table 3-J

Size	1210											
VDC (V)	10	16	25	50	100	200	250	500	630	1000	1500	2000
470pF (471)	C	C	C	C	C	C	C	C	C	G	M	M
560pF (561)	C	C	C	C	C	C	C	C	C	G		
680pF (681)	C	C	C	C	C	C	C	C	C	G		
820pF (821)	C	C	C	C	C	C	C	C	C	G		
1,000pF (102)	C	C	C	C	C	D	D	D	D	G		
1,200pF (122)	C	C	C	C	C	D	D	D	D	G		
1,500pF (152)	C	C	C	C	C	D	D	D	D	K		
1,800pF (182)	C	C	C	C	C	D	D	D	D	M		
2,200pF (222)	C	C	C	C	C	D	D	D	D	M		
2,700pF (272)	C	C	C	C	C	D	D	D	D	M		
3,300pF (332)	C	C	C	C	C	D	D	D	D	M		
3,900pF (392)	C	C	C	C	C	D	D	D	D	M		
4,700pF (472)	C	C	C	C	C	G	G					
5,600pF (562)	C	C	C	C	C	G	G					
6,800pF (682)	C	C	C	C	C	G	G					
8,200pF (822)	C	C	C	C	C	G	G					
0.010μF (103)	C	C	C	C	C	G	G					
0.012μF (123)	D	D	D	D	D							
0.015μF (153)	D	D	D	D	D							

CAPACITANCE RANGE - NPO DIELECTRIC 1808 SIZES
Table 3-K

Size	1808					
VDC (V)	500	630	1000	1500	2000	3000
2.0pF (2R0)	D	D	D	D	D	D
2.2pF (2R2)	D	D	D	D	D	D
2.7pF (2R7)	D	D	D	D	D	D
3.3pF (3R3)	D	D	D	D	D	D
3.9pF (3R9)	D	D	D	D	D	D
4.7pF (4R7)	D	D	D	D	D	D

MULTILAYER CERAMIC CHIP CAPACITORS SH SERIES
CAPACITANCE RANGE - NPO DIELECTRIC 1808 SIZES
Table 3-L

Size	1808					
	500	630	1000	1500	2000	3000
VDC (V)	500	630	1000	1500	2000	3000
5.6pF (5R6)	D	D	D	D	D	D
6.8pF (6R8)	D	D	D	D	D	D
8.2pF (8R2)	D	D	D	D	D	D
10pF (100)	D	D	D	D	D	D
12pF (120)	D	D	D	D	D	D
15pF (150)	D	D	D	D	D	D
18pF (180)	D	D	D	D	D	D
22pF (220)	D	D	D	D	D	D
27pF (270)	D	D	D	D	D	D
33pF (330)	D	D	D	D	D	D
39pF (390)	D	D	D	D	D	D
47pF (470)	D	D	D	D	D	D
56pF (560)	D	D	D	D	D	D
68pF (680)	D	D	D	D	D	D
82pF (820)	D	D	D	D	D	D
100pF (101)	D	D	D	D	D	K
120pF (121)	D	D	D	D	D	K
150pF (151)	D	D	D	K	K	K
180pF (181)	D	D	D	K	K	K
220pF (221)	D	D	D	K	K	K
270pF (271)	K	K	K	K	K	K
330pF (331)	K	K	K	K	K	K
390pF (391)	K	K	K	K	K	K
470pF (471)	K	K	K	K	K	
560pF (561)	K	K	K	K	K	
680pF (681)	K	K	K	K	K	
820pF (821)	K	K	K	D	D	
1,000pF (102)	K	K	K	G	G	
1,200pF (122)	K	K	G			
1,500pF (152)	K	K	G			

MULTILAYER CERAMIC CHIP CAPACITORS SH SERIES

CAPACITANCE RANGE - NPO DIELECTRIC 1808 SIZES

Table 3-M

Size	1808					
VDC (V)	500	630	1000	1500	2000	3000
1,800pF (182)	K	K	K			
2,200pF (222)	K	K	K			
2,700pF (272)	K	K				
3,300pF (332)	K	K				

CAPACITANCE RANGE - NPO DIELECTRIC 1812 SIZES

Table 3-N

Size	1812												
VDC (V)	10	16	25	50	100	200	250	500	630	1000	1500	2000	3000
10pF (100)	D	D	D	D	D	D	D	D	D	D	D	D	D
12pF (120)	D	D	D	D	D	D	D	D	D	D	D	D	D
15pF (150)	D	D	D	D	D	D	D	D	D	D	D	D	D
18pF (180)	D	D	D	D	D	D	D	D	D	D	D	D	D
22pF (220)	D	D	D	D	D	D	D	D	D	D	D	D	D
27pF (270)	D	D	D	D	D	D	D	D	D	D	D	D	D
33pF (330)	D	D	D	D	D	D	D	D	D	D	D	D	D
39pF (390)	D	D	D	D	D	D	D	D	D	D	D	D	D
47pF (470)	D	D	D	D	D	D	D	D	D	D	D	D	D
56pF (560)	D	D	D	D	D	D	D	D	D	D	D	D	D
68pF (680)	D	D	D	D	D	D	D	D	D	D	D	D	D
82pF (820)	D	D	D	D	D	D	D	D	D	D	D	D	D
100pF (101)	D	D	D	D	D	D	D	D	D	D	D	D	D
120pF (121)	D	D	D	D	D	D	D	D	D	D	D	D	D
150pF (151)	D	D	D	D	D	D	D	D	D	D	D	D	D
180pF (181)	D	D	D	D	D	D	D	D	D	D	D	D	K
220pF (221)	D	D	D	D	D	D	D	D	D	D	D	D	K
270pF (271)	D	D	D	D	D	D	D	D	D	D	K	K	K
330pF (331)	D	D	D	D	D	D	D	D	D	D	K	K	K
390pF (391)	D	D	D	D	D	D	D	D	D	D	K	K	K
470pF (471)	D	D	D	D	D	D	D	D	D	K	K	K	K

MULTILAYER CERAMIC CHIP CAPACITORS SH SERIES

CAPACITANCE RANGE - NPO DIELECTRIC 1812 SIZES

Table 3-0

Size	1812												
VDC (V)	10	16	25	50	100	200	250	500	630	1000	1500	2000	3000
560pF (561)	D	D	D	D	D	D	D	D	D	K	K	K	
680pF (681)	D	D	D	D	D	D	D	D	D	K	K	K	
820pF (821)	D	D	D	D	D	D	D	D	D	K	K	K	
1,000pF (102)	D	D	D	D	D	D	D	D	D	K	K	K	
1,200pF (122)	D	D	D	D	D	D	D	D	D	K			
1,500pF (152)	D	D	D	D	D	D	D	D	D	K			
1,800pF (182)	D	D	D	D	D	D	D	D	D	K			
2,200pF (222)	D	D	D	D	D	D	D	D	D	K			
2,700pF (272)	D	D	D	D	D	D	D	D	D	K			
3,300pF (332)	D	D	D	D	D	D	D	D	D	K			
3,900pF (392)	D	D	D	D	D	D	D	D	D	M			
4,700pF (472)	D	D	D	D	D	D	D	D	D				
5,600pF (562)	D	D	D	D	D	D	D	D	D				
6,800pF (682)	D	D	D	D	D	D	D	D	D				
8,200pF (822)	D	D	D	D	D			D	D				
0.010μF (103)	D	D	D	D	D			D	D				
0.012μF (123)	D	D	D	D	D			G	G				
0.015μF (153)	D	D	D	D	D			G	G				
0.018μF (183)	D	D	D	D	D			K	K				
0.022μF (223)	D	D	D	D	D			K	K				
0.027μF (273)	D	D	D	D	D								
0.033μF (333)	D	D	D	D	D								

MULTILAYER CERAMIC CHIP CAPACITORS SH SERIES

CAPACITANCE RANGE - NP0 DIELECTRIC 1825 SIZES

Table 3-P

Size	1825							
VDC (V)	100	200	250	500	630	1000	2000	3000
10pF (100)	K	K	K	K	K	K	K	K
12pF (120)	K	K	K	K	K	K	K	K
15pF (150)	K	K	K	K	K	K	K	K
18pF (180)	K	K	K	K	K	K	K	K
22pF (220)	K	K	K	K	K	K	K	K
27pF (270)	K	K	K	K	K	K	K	K
33pF (330)	K	K	K	K	K	K	K	K
39pF (390)	K	K	K	K	K	K	K	K
47pF (470)	K	K	K	K	K	K	K	K
56pF (560)	K	K	K	K	K	K	K	K
68pF (680)	K	K	K	K	K	K	K	K
82pF (820)	K	K	K	K	K	K	K	K
100pF (101)	K	K	K	K	K	K	K	K
120pF (121)	K	K	K	K	K	K	K	K
150pF (151)	K	K	K	K	K	K	K	K
180pF (181)	K	K	K	K	K	K	K	K
220pF (221)	K	K	K	K	K	K	K	K
270pF (271)	K	K	K	K	K	K	K	K
330pF (331)	K	K	K	K	K	K	K	K
390pF (391)	K	K	K	K	K	K	K	K
470pF (471)	K	K	K	K	K	K	K	K
560pF (561)	K	K	K	K	K	K	K	K
680pF (681)	K	K	K	K	K	K	K	M
820pF (821)	K	K	K	K	K	K	K	M
1,000pF (102)	K	K	K	K	K	K	K	M
1,200pF (122)	K	K	K	K	K	K	K	
1,500pF (152)	K	K	K	K	K	K	M	
1,800pF (182)	K	K	K	K	K	K	M	
2,200pF (222)	K	K	K	K	K	K	M	

MULTILAYER CERAMIC CHIP CAPACITORS SH SERIES

CAPACITANCE RANGE - NP0 DIELECTRIC 1825 SIZES

Table 3-Q

Size	1825							
VDC (V)	100	200	250	500	630	1000	2000	3000
2,700pF (272)	K	K	K	K	K	K	M	
3,300pF (332)	K	K	K	K	K	K	M	
3,900pF (392)	K	K	K	K	K	M	M	
4,700pF (472)	K	K	K	K	K	M	M	
5,600pF (562)	K	K	K	K	K	M		
6,800pF (682)	K	K	K	K	K	M		
8,200pF (822)	K	K	K	K	K	M		
0.010μF (103)	K	K	K	K	K	M		
0.012μF (123)	K	K	K	K	K			
0.015μF (153)	K	K	K	K	K			
0.018μF (183)	K	K	K	K	K			
0.022μF (223)	K	K	K	K	K			
0.027μF (273)	K	K	K	K	K			
0.033μF (333)	K	K	K	K	K			
0.039μF (393)	K	K	K	M	M			
0.047μF (473)	K	K	K					
0.056μF (563)	K	M	M					
0.068μF (683)	K	M	M					
0.082μF (823)	M							
0.1μF (104)	M							

MULTILAYER CERAMIC CHIP CAPACITORS SH SERIES

CAPACITANCE RANGE - NP0 DIELECTRIC 2220 SIZES

Table 3-R

Size	2220							
VDC (V)	100	200	250	500	630	1000	2000	3000
10pF (100)	K	K	K	K	K	K	K	K
12pF (120)	K	K	K	K	K	K	K	K
15pF (150)	K	K	K	K	K	K	K	K
18pF (180)	K	K	K	K	K	K	K	K
22pF (220)	K	K	K	K	K	K	K	K
27pF (270)	K	K	K	K	K	K	K	K
33pF (330)	K	K	K	K	K	K	K	K
39pF (390)	K	K	K	K	K	K	K	K
47pF (470)	K	K	K	K	K	K	K	K
56pF (560)	K	K	K	K	K	K	K	K
68pF (680)	K	K	K	K	K	K	K	K
82pF (820)	K	K	K	K	K	K	K	K
100pF (101)	K	K	K	K	K	K	K	K
120pF (121)	K	K	K	K	K	K	K	K
150pF (151)	K	K	K	K	K	K	K	K
180pF (181)	K	K	K	K	K	K	K	K
220pF (221)	K	K	K	K	K	K	K	K
270pF (271)	K	K	K	K	K	K	K	K
330pF (331)	K	K	K	K	K	K	K	M
390pF (391)	K	K	K	K	K	K	K	M
470pF (471)	K	K	K	K	K	K	K	M
560pF (561)	K	K	K	K	K	K	K	M
680pF (681)	K	K	K	K	K	K	K	M
820pF (821)	K	K	K	K	K	K	K	M
1,000pF (102)	K	K	K	K	K	M	M	M
1,200pF (122)	K	K	K	K	K	M	M	M
1,500pF (152)	K	K	K	K	K	M	M	
1,800pF (182)	K	K	K	K	K	M	M	
2,200pF (222)	K	K	K	K	K	M	M	

MULTILAYER CERAMIC CHIP CAPACITORS SH SERIES

CAPACITANCE RANGE - NP0 DIELECTRIC 2220 SIZES

Table 3-5

Size	2220							
VDC (V)	100	200	250	500	630	1000	2000	3000
2,700pF (272)	K	K	K	K	K	M	M	
3,300pF (332)	K	K	K	K	K	M	M	
3,900pF (392)	K	K	K	K	K	M	M	
4,700pF (472)	K	K	K	K	K	M	M	
5,600pF (562)	K	K	K	K	K	M		
6,800pF (682)	K	K	K	K	K	M		
8,200pF (822)	K	K	K	K	K	M		
0.010μF (103)	K	K	K	K	K	M		
0.012μF (123)	K	K	K	K	K			
0.015μF (153)	K	K	K	K	K			
0.018μF (183)	K	K	K	K	K			
0.022μF (223)	K	K	K	K	K			
0.027μF (273)	K	K	K	K				
0.033μF (333)	K	K	K	K				
0.039μF (393)	K	K	K	M				
0.047μF (473)	K	M	M	M				
0.056μF (563)	K	M	M					
0.068μF (683)	K	M	M					
0.082μF (823)	M							
0.1μF (104)	M							

MULTILAYER CERAMIC CHIP CAPACITORS SH SERIES

CAPACITANCE RANGE - NP0 DIELECTRIC 2225 SIZES

Table 3-T

Size	2225							
VDC (V)	100	200	250	500	630	1000	2000	3000
10pF (100)	K	K	K	K	K	K	K	K
12pF (120)	K	K	K	K	K	K	K	K
15pF (150)	K	K	K	K	K	K	K	K
18pF (180)	K	K	K	K	K	K	K	K
22pF (220)	K	K	K	K	K	K	K	K
27pF (270)	K	K	K	K	K	K	K	K
33pF (330)	K	K	K	K	K	K	K	K
39pF (390)	K	K	K	K	K	K	K	K
47pF (470)	K	K	K	K	K	K	K	K
56pF (560)	K	K	K	K	K	K	K	K
68pF (680)	K	K	K	K	K	K	K	K
82pF (820)	K	K	K	K	K	K	K	K
100pF (101)	K	K	K	K	K	K	K	K
120pF (121)	K	K	K	K	K	K	K	K
150pF (151)	K	K	K	K	K	K	K	K
180pF (181)	K	K	K	K	K	K	K	K
220pF (221)	K	K	K	K	K	K	K	K
270pF (271)	K	K	K	K	K	K	K	K
330pF (331)	K	K	K	K	K	K	K	K
390pF (391)	K	K	K	K	K	K	K	K
470pF (471)	K	K	K	K	K	K	K	K
560pF (561)	K	K	K	K	K	K	K	K
680pF (681)	K	K	K	K	K	K	K	K
820pF (821)	K	K	K	K	K	K	M	M
1,000pF (102)	K	K	K	K	K	K	M	M
1,200pF (122)	K	K	K	K	K	K	M	
1,500pF (152)	K	K	K	K	K	K	M	
1,800pF (182)	K	K	K	K	K	K	M	
2,200pF (222)	K	K	K	K	K	K	M	

MULTILAYER CERAMIC CHIP CAPACITORS SH SERIES

CAPACITANCE RANGE - NP0 DIELECTRIC 2225 SIZES

Table 3-U

Size	2225							
VDC (V)	100	200	250	500	630	1000	2000	3000
2,700pF (272)	K	K	K	K	K	K	M	
3,300pF (332)	K	K	K	K	K	K	M	
3,900pF (392)	K	K	K	K	K	K	M	
4,700pF (472)	K	K	K	K	K	K	M	
5,600pF (562)	K	K	K	K	K	M	M	
6,800pF (682)	K	K	K	K	K	M	M	
8,200pF (822)	K	K	K	K	K	M	M	
0.010μF (103)	K	K	K	K	K	M	M	
0.012μF (123)	K	K	K	K	K			
0.015μF (153)	K	K	K	K	K			
0.018μF (183)	K	K	K	K	K			
0.022μF (223)	K	K	K	K	K			
0.027μF (273)	K	K	K	K	K			
0.033μF (333)	K	K	K	K	K			
0.039μF (393)	K	K	K	K	K			
0.047μF (473)	K	K	K	K	K			
0.056μF (563)	K	M	M	M	M			
0.068μF (683)	K	M	M	M				
0.082μF (823)	K	M	M	M				
0.1μF (104)	M	M	M					

MULTILAYER CERAMIC CHIP CAPACITORS SH SERIES

CAPACITANCE RANGE – X7R DIELECTRIC 0402, 0603 SIZES

Table 4-A

Size	0402					0603						
	VDC (V)	10	16	25	50	100	10	16	25	50	100	200
100pF (101)	E	E	E	E	E	S	S	S	S	S	X	X
120pF (121)	E	E	E	E	E	S	S	S	S	S	X	X
150pF (151)	E	E	E	E	E	S	S	S	S	S	X	X
180pF (181)	E	E	E	E	E	S	S	S	S	S	X	X
220pF (221)	E	E	E	E	E	S	S	S	S	S	X	X
270pF (271)	E	E	E	E	E	S	S	S	S	S	X	X
330pF (331)	E	E	E	E	E	S	S	S	S	S	X	X
390pF (391)	E	E	E	E	E	S	S	S	S	S	X	X
470pF (471)	E	E	E	E	E	S	S	S	S	S	X	X
560pF (561)	E	E	E	E	E	S	S	S	S	S	X	X
680pF (681)	E	E	E	E	E	S	S	S	S	S	X	X
820pF (821)	E	E	E	E	E	S	S	S	S	S	X	X
1,000pF (102)	E	E	E	E	E	S	S	S	S	S	X	X
1,200pF (122)	E	E	E	E	E	S	S	S	S	S	X	X
1,500pF (152)	E	E	E	E	E	S	S	S	S	S	X	X
1,800pF (182)	E	E	E	E	E	S	S	S	S	S	X	X
2,200pF (222)	E	E	E	E	E	S	S	S	S	S	X	X
2,700pF (272)	E	E	E	E	E	S	S	S	S	S	X	X
3,300pF (332)	E	E	E	E	E	S	S	S	S	S	X	X
3,900pF (392)	E	E	E	E	E	S	S	S	S	S	X	X
4,700pF (472)	E	E	E	E	E	S	S	S	S	S	X	X
5,600pF (562)	E	E	E	E	E	S	S	S	S	S	X	X
6,800pF (682)	E	E	E	E	E	S	S	S	S	S	X	X
8,200pF (822)	E	E	E	E	E	S	S	S	S	S	X	X
0.010μF (103)	E	E	E	E	E	S	S	S	S	S	X	X
0.012μF (123)	E	E	E	E	E	S	S	S	S	X		
0.015μF (153)	E	E	E	E	E	S	S	S	S	X		
0.018μF (183)	E	E	E	E	E	S	S	S	S	X		
0.022μF (223)	E	E	E	E	E	S	S	S	S	X		
0.027μF (273)	E	E	E	E	E	S	S	S	S	X		
0.033μF (333)	E	E	E	E	E	S	S	S	X	X		

MULTILAYER CERAMIC CHIP CAPACITORS SH SERIES

CAPACITANCE RANGE – X7R DIELECTRIC 0402, 0603 SIZES

Table 4-B

Size	0402					0603							
	VDC (V)	10	16	25	50	100	10	16	25	50	100	200	250
0.039µF (393)	E	E	E				S	S	S	X	X		
0.047µF (473)	E	E	E				S	S	S	X	X		
0.056µF (563)	E	E					S	S	S	X	X		
0.068µF (683)	E	E					S	S	S	X	X		
0.082µF (823)	E	E					S	S	S	X	X		
0.10µF (104)	E	E					S	S	S	X	X		
0.12µF (124)							S	S	X				
0.15µF (154)							S	S	X				
0.18µF (184)							S	S	X				
0.22µF (224)							S	S	X	X			
0.27µF (274)							X	X	X				
0.33µF (334)							X	X	X				
0.39µF (394)							X	X	X				
0.47µF (474)							X	X	X				
0.56µF (564)							X	X					
0.68µF (684)							X	X					
0.82µF (824)							X	X					
1.0µF (105)							X	X	X				

CAPACITANCE RANGE – X7R DIELECTRIC 0805 SIZES

Table 4-C

Size	0805										
	VDC (V)	10	16	25	50	100	200	250	500	630	1000
100pF (101)	D	D	D	D	D	D	D	D	B	B	B
120pF (121)	D	D	D	D	D	D	D	D	B	B	B
150pF (151)	D	D	D	D	D	D	D	D	B	B	B
180pF (181)	D	D	D	D	D	D	D	D	B	B	B
220pF (221)	D	D	D	D	D	D	D	D	B	B	B
270pF (271)	D	D	D	D	D	D	D	D	B	B	B
330pF (331)	D	D	D	D	D	D	D	D	B	B	B
390pF (391)	D	D	D	D	D	D	D	D	B	B	B
470pF (471)	D	D	D	D	D	D	D	D	B	B	B
560pF (561)	D	D	D	D	D	D	D	D	B	B	B

MULTILAYER CERAMIC CHIP CAPACITORS SH SERIES

CAPACITANCE RANGE – X7R DIELECTRIC 0805 SIZES

Table 4-D

Size	0805										
	VDC (V)	10	16	25	50	100	200	250	500	630	1000
680pF (681)	D	D	D	D	D	D	D	D	B	B	B
820pF (821)	D	D	D	D	D	D	D	D	B	B	B
1,000pF (102)	D	D	D	D	D	D	D	D	B	B	B
1,200pF (122)	D	D	D	D	D	D	D	D	B	B	B
1,500pF (152)	D	D	D	D	D	D	D	D	B	B	D
1,800pF (182)	D	D	D	D	D	D	D	D	B	B	D
2,200pF (222)	D	D	D	D	D	D	D	D	B	B	D
2,700pF (272)	D	D	D	D	D	D	D	D	B	B	
3,300pF (332)	D	D	D	D	D	D	D	D	B	B	
3,900pF (392)	D	D	D	D	D	D	D	D	B	B	
4,700pF (472)	D	D	D	D	D	D	D	D	D	D	
5,600pF (562)	D	D	D	D	D	D	D	D	D	D	
6,800pF (682)	D	D	D	D	D	D	D	D	D	D	
8,200pF (822)	D	D	D	D	D	D	D	D	D	D	
0.010μF (103)	D	D	D	D	D	D	D	D	D	D	
0.012μF (123)	D	D	D	D	D	D	D	D	D	D	
0.015μF (153)	D	D	D	D	D	D	D	D	D	D	
0.018μF (183)	D	D	D	D	D	D	D	D	D	D	
0.022μF (223)	D	D	D	D	D	D	D	D	D	D	
0.027μF (273)	D	D	D	D	D	D	D	D	D	D	
0.033μF (333)	D	D	D	D	D	D	D	D	D		
0.039μF (393)	D	D	D	D	D	D	D	D			
0.047μF (473)	D	D	D	D	D	D	D	D			
0.056μF (563)	D	D	D	D	D	D	D	D			
0.068μF (683)	D	D	D	D	D	D	D	D			
0.082μF (823)	D	D	D	D	D	D	D				
0.10μF (104)	D	D	D	D	D	D					
0.12μF (124)	D	D	D	D	I						
0.15μF (154)	D	D	D	D	I						
0.18μF (184)	D	D	D	D	I						
0.22μF (224)	D	D	D	D	I						
0.27μF (274)	I	I	I	I							
0.33μF (334)	I	I	I	I							

MULTILAYER CERAMIC CHIP CAPACITORS SH SERIES

CAPACITANCE RANGE – X7R DIELECTRIC 0805 SIZES

Table 4-E

Size	0805									
VDC (V)	10	16	25	50	100	200	250	500	630	1000
0.39µF (394)	I	I	I	I						
0.47µF (474)	I	I	I	I						
0.56µF (564)	I	I	I							
0.68µF (684)	I	I	I							
0.82µF (824)	I	I	I							
1.0µF (105)	I	I	I	I						
1.5µF (155)	I	I	I							
2.2µF (225)	I	I	I							
4.7µF (475)	I	I	I							

CAPACITANCE RANGE – X7R DIELECTRIC 1206 SIZES

Table 4-F

Size	1206													
VDC (V)	10	16	25	50	100	200	250	400	450	500	630	1000	1500	2000
100pF (101)						D	D			D	D	D	D	D
120pF (121)						D	D			D	D	D	D	D
150pF (151)	D	D	D	D	D	D	D			D	D	D	D	D
180pF (181)	D	D	D	D	D	D	D			D	D	D	D	D
220pF (221)	D	D	D	D	D	D	D			D	D	D	D	D
270pF (271)	D	D	D	D	D	D	D			D	D	D	D	D
330pF (331)	D	D	D	D	D	D	D			D	D	D	D	D
390pF (391)	D	D	D	D	D	D	D			D	D	D	D	D
470pF (471)	D	D	D	D	D	D	D			D	D	D	D	D
560pF (561)	D	D	D	D	D	D	D			D	D	D	D	D
680pF (681)	D	D	D	D	D	D	D			D	D	D	D	D
820pF (821)	D	D	D	D	D	D	D			D	D	D	G	G
1,000pF (102)	D	D	D	D	D	D	D			D	D	D	G	G
1,200pF (122)	D	D	D	D	D	D	D			D	D	D	G	G
1,500pF (152)	D	D	D	D	D	D	D			D	D	D	G	G
1,800pF (182)	D	D	D	D	D	D	D			D	D	D	G	G

MULTILAYER CERAMIC CHIP CAPACITORS SH SERIES

CAPACITANCE RANGE – X7R DIELECTRIC 1206 SIZES

Table 4-G

Size	1206													
	10	16	25	50	100	200	250	400	450	500	630	1000	1500	2000
VDC (V)	10	16	25	50	100	200	250	400	450	500	630	1000	1500	2000
2,200pF (222)	D	D	D	D	D	D	D			D	D	D	G	G
2,700pF (272)	D	D	D	D	D	D	D			D	D	D	G	G
3,300pF (332)	D	D	D	D	D	D	D			D	D	D	G	G
3,900pF (392)	D	D	D	D	D	D	D			D	D	D	G	
4,700pF (472)	D	D	D	D	D	D	D			D	D	D	G	
5,600pF (562)	D	D	D	D	D	D	D			D	D	D	G	
6,800pF (682)	D	D	D	D	D	D	D			D	D	D	G	
8,200pF (822)	D	D	D	D	D	D	D			D	D	D	G	
0.010μF (103)	D	D	D	D	D	D	D			D	D	D	G	
0.012μF (123)	D	D	D	D	D	D	D			D	D	G		
0.015μF (153)	D	D	D	D	D	D	D			D	D	G		
0.018μF (183)	D	D	D	D	D	D	D			D	D			
0.022μF (223)	D	D	D	D	D	D	D			G	G			
0.027μF (273)	D	D	D	D	D	D	D			G	G			
0.033μF (333)	D	D	D	D	D	G	G			G	G			
0.039μF (393)	D	D	D	D	D	G	G			G	G			
0.047μF (473)	D	D	D	D	D	G	G			G	G			
0.056μF (563)	D	D	D	D	D	G	G			G	G			
0.068μF (683)	D	D	D	D	D	G	G	G	G					
0.082μF (823)	D	D	D	D	D	G	G	G	G					
0.10μF (104)	D	D	D	D	D	G	G	G	G					
0.12μF (124)	D	D	D	D	D									
0.15μF (154)	C	C	C	C	G									

MULTILAYER CERAMIC CHIP CAPACITORS SH SERIES
CAPACITANCE RANGE – X7R DIELECTRIC 1206 SIZES
Table 4-H

Size	1206													
VDC (V)	10	16	25	50	100	200	250	400	450	500	630	1000	1500	2000
0.18μF (184)	C	C	C	C	G									
0.22μF (224)	C	C	C	C	G									
0.27μF (274)	C	C	C	D	G									
0.33μF (334)	C	C	C	D	G									
0.39μF (394)	C	C	J	P	G									
0.47μF (474)	J	J	J	P	G									
0.56μF (564)	J	J	J	P	P									
0.68μF (684)	J	J	J	P	P									
0.82μF (824)	J	J	J	P	P									
1.0μF (105)	J	J	J	P	P									
1.5μF (155)	J	J	P	P	P									
2.2μF (225)	J	J	P	P	P									
3.3μF (335)	P	P	P											
4.7μF (475)	P	P	P											
10μF (106)	P	P	P											
22μF (226)	P													

CAPACITANCE RANGE – X7R DIELECTRIC 1210 SIZES
Table 4-I

Size	1210													
VDC (V)	10	16	25	50	100	200	250	400	450	500	630	1000	1500	2000
100pF (101)										D	D	D	D	D
120pF (121)										D	D	D	D	D
150pF (151)										D	D	D	D	D
180pF (181)										D	D	D	D	D
220pF (221)										D	D	D	D	D
270pF (271)										D	D	D	D	D
330pF (331)										D	D	D	D	D

MULTILAYER CERAMIC CHIP CAPACITORS SH SERIES

CAPACITANCE RANGE – X7R DIELECTRIC 1210 SIZES

Table 4-J

Size	1210													
	10	16	25	50	100	200	250	400	450	500	630	1000	1500	2000
VDC (V)														
390pF (391)										D	D	D	D	D
470pF (471)										D	D	D	D	D
560pF (561)										D	D	D	D	D
680pF (681)										D	D	D	D	D
820pF (821)										D	D	D	D	D
1,000pF (102)	C	C	C	C	C	C	C			D	D	D	D	D
1,200pF (122)	C	C	C	C	C	C	C			D	D	D	M	M
1,500pF (152)	C	C	C	C	C	C	C			D	D	D	M	M
1,800pF (182)	C	C	C	C	C	C	C			D	D	D	M	M
2,200pF (222)	C	C	C	C	C	C	C			D	D	D	M	M
2,700pF (272)	C	C	C	C	C	C	C			D	D	D	M	M
3,300pF (332)	C	C	C	C	C	C	C			D	D	D	M	M
3,900pF (392)	C	C	C	C	C	C	C			D	D	G	M	M
4,700pF (472)	C	C	C	C	C	C	C			D	D	G	M	M
5,600pF (562)	C	C	C	C	C	C	C			D	D	G	M	M
6,800pF (682)	C	C	C	C	C	C	C			D	D	G	M	M
8,200pF (822)	C	C	C	C	C	C	C			D	D	G	M	M
0.010µF (103)	C	C	C	C	C	C	C			D	D	G		
0.012µF (123)	C	C	C	C	C	C	C			D	D	G		
0.015µF (153)	C	C	C	C	C	C	C			D	D	G		
0.018µF (183)	C	C	C	C	C	C	C			D	D	G		
0.022µF (223)	C	C	C	C	C	C	C			D	D	G		
0.027µF (273)	C	C	C	C	C	C	C			G	G	G		

MULTILAYER CERAMIC CHIP CAPACITORS SH SERIES

CAPACITANCE RANGE – X7R DIELECTRIC 1210 SIZES

Table 4-K

Size	1210															
	VDC (V)	6.3	10	16	25	50	100	200	250	400	450	500	630	1000	1500	2000
0.033μF (333)		C	C	C	C	C	C	C	C			G	G	G		
0.039μF (393)		C	C	C	C	C	C	C				G	G	K		
0.047μF (473)		C	C	C	C	C	D	D				G	G	M		
0.056μF (563)		C	C	C	C	C	D	D				G	G			
0.068μF (683)		C	C	C	C	C	G	G				K	K			
0.082μF (823)		C	C	C	C	C	G	G				K	K			
0.10μF (104)		C	C	C	C	C	G	G				K	K			
0.12μF (124)		C	C	C	C	C	G	G	M	M						
0.15μF (154)		C	C	C	C	D	M	M	M	M						
0.18μF (184)		C	C	C	C	D	M	M	M	M						
0.22μF (224)		C	C	C	C	D	M	M	M	M						
0.27μF (274)		C	C	C	C	G	M	M	M	M						
0.33μF (334)		C	C	C	D	G	M	M	M	M						
0.39μF (394)		C	C	C	D	M	M	M								
0.47μF (474)		C	C	C	D	M	M	M								
0.56μF (564)		D	D	D	D	M	M	M								
0.68μF (684)		D	D	D	D	K	M	M								
0.82μF (824)		D	D	D	D	K										
1.0μF (105)		D	D	D	D	K										
1.5μF (155)			K	G	M	M										
2.2μF (225)			K	G	M	M										
3.3μF (335)			K	G	M											
4.7μF (475)		K	K	K	M	M										
10μF (106)		K	K	M	M											
22μF (226)			M													
47μF (476)	M															

MULTILAYER CERAMIC CHIP CAPACITORS SH SERIES

CAPACITANCE RANGE – X7R DIELECTRIC 1808 SIZES

Table 4-L

Size	1808					
VDC (V)	500	630	1000	1500	2000	3000
150pF (151)	D	D	D	D	D	D
180pF (181)	D	D	D	D	D	D
220pF (221)	D	D	D	D	D	D
270pF (271)	D	D	D	D	D	D
330pF (331)	D	D	D	D	D	K
390pF (391)	D	D	D	D	D	K
470pF (471)	D	D	D	D	D	K
560pF (561)	D	D	D	D	D	K
680pF (681)	D	D	D	D	D	K
820pF (821)	D	D	D	D	D	K
1,000pF (102)	D	D	D	K	K	K
1,200pF (122)	D	D	D	K	K	K
1,500pF (152)	D	D	D	K	K	K
1,800pF (182)	D	D	D	K	K	K
2,200pF (222)	D	D	D	K	K	
2,700pF (272)	D	D	D	K	K	
3,300pF (332)	D	D	D	K	K	
3,900pF (392)	D	D	D	K	K	
4,700pF (472)	D	D	D	K	K	
5,600pF (562)	K	K	K	K	K	
6,800pF (682)	K	K	K	K	K	
8,200pF (822)	K	K	K			
0.010μF (103)	K	K	K			
0.012μF (123)	K	K	K			
0.015μF (153)	K	K	K			
0.018μF (183)	K	K	K			
0.022μF (223)	K	K	K			

MULTILAYER CERAMIC CHIP CAPACITORS SH SERIES

CAPACITANCE RANGE – X7R DIELECTRIC 1808 SIZES

Table 4-M

Size	1808					
VDC (V)	500	630	1000	1500	2000	3000
0.027μF (273)	K	K	K			
0.033μF (333)	K	K	K			
0.039μF (393)	K	K	K			
0.047μF (473)	K	K	K			
0.056μF (563)	K	K	K			
0.068μF (683)	K	K				
0.082μF (823)	K	K				

MULTILAYER CERAMIC CHIP CAPACITORS SH SERIES

CAPACITANCE RANGE – X7R DIELECTRIC 1812 SIZES

Table 4-N

Size	1812													
	VDC (V)	10	16	25	50	100	200	250	500	630	1000	1500	2000	3000
270pF (271)							D	D	D	D	D	D	D	K
330pF (331)							D	D	D	D	D	D	D	K
390pF (391)							D	D	D	D	D	D	D	K
470pF (471)							D	D	D	D	D	D	D	K
560pF (561)							D	D	D	D	D	D	D	K
680pF (681)							D	D	D	D	D	D	D	K
820pF (821)							D	D	D	D	D	D	D	K
1,000pF (102)	D	D	D	D	D	D	D	D	D	D	D	D	D	K
1,200pF (122)	D	D	D	D	D	D	D	D	D	D	D	D	D	K
1,500pF (152)	D	D	D	D	D	D	D	D	D	D	D	D	D	K
1,800pF (182)	D	D	D	D	D	D	D	D	D	D	D	G	G	M
2,200pF (222)	D	D	D	D	D	D	D	D	D	D	D	G	G	M
2,700pF (272)	D	D	D	D	D	D	D	D	D	D	D	G	G	M
3,300pF (332)	D	D	D	D	D	D	D	D	D	D	D	K	K	M
3,900pF (392)	D	D	D	D	D	D	D	D	D	D	D	K	K	M
4,700pF (472)	D	D	D	D	D	D	D	D	D	D	D	K	K	M
5,600pF (562)	D	D	D	D	D	D	D	D	D	D	D	M	M	M
6,800pF (682)	D	D	D	D	D	D	D	D	D	D	D	M	M	M
8,200pF (822)	D	D	D	D	D	D	D	D	D	D	D	M	M	
0.010µF (103)	D	D	D	D	D	D	D	D	D	D	D	M	M	
0.012µF (123)	D	D	D	D	D	D	D	D	D	D	K			
0.015µF (153)	D	D	D	D	D	D	D	D	D	D	K			
0.018µF (183)	D	D	D	D	D	D	D	D	D	D	M			
0.022µF (223)	D	D	D	D	D	D	D	D	D	D	M			
0.027µF (273)	D	D	D	D	D	D	D	D	D	D	M			
0.033µF (333)	D	D	D	D	D	D	D	D	D	D	M			
0.039µF (393)	D	D	D	D	D	D	D	D	D	D	M			

MULTILAYER CERAMIC CHIP CAPACITORS SH SERIES

CAPACITANCE RANGE – X7R DIELECTRIC 1812 SIZES

Table 4-0

Size	1812												
VDC (V)	10	16	25	50	100	200	250	500	630	1000	1500	2000	3000
0.047μF (473)	D	D	D	D	D	D	D	D	D	M			
0.056μF (563)	D	D	D	D	D	D	D	K	K	M			
0.068μF (683)	D	D	D	D	D	D	D	K	K	M			
0.082μF (823)	D	D	D	D	D	D	D	K	K	M			
0.10μF (104)	D	D	D	D	D	D	D	K	K	M			
0.12μF (124)	D	D	D	D	D	D	D	M	M				
0.15μF (154)	D	D	D	D	D	K	K	M	M				
0.18μF (184)	D	D	D	D	D	K	K	M	M				
0.22μF (224)	D	D	D	D	D	K	K	M	M				
0.27μF (274)	D	D	D	D	D	K	K	M					
0.33μF (334)	D	D	D	D	D	K	K	M					
0.39μF (394)	D	D	D	D	D	K	K	M					
0.47μF (474)	D	D	D	D	K	K	K	M					
0.56μF (564)	D	D	D	D	K	M	M						
0.68μF (684)	D	D	D	K	K	M	M						
0.82μF (824)	D	D	D	K	K	M	M						
1.0μF (105)	D	D	D	K	K	M	M						
1.5μF (155)					K								
2.2μF (225)				M	M								

MULTILAYER CERAMIC CHIP CAPACITORS SH SERIES

CAPACITANCE RANGE – X7R DIELECTRIC 1825 SIZES

Table 4-P

Size	1825					
VDC (V)	250	500	630	1000	2000	3000
1,000pF (102)	K	K	K	K	K	K
1,200pF (122)	K	K	K	K	K	K
1,500pF (152)	K	K	K	K	K	K
1,800pF (182)	K	K	K	K	K	K
2,200pF (222)	K	K	K	K	K	K
2,700pF (272)	K	K	K	K	K	K
3,300pF (332)	K	K	K	K	K	K
3,900pF (392)	K	K	K	K	K	K
4,700pF (472)	K	K	K	K	K	K
5,600pF (562)	K	K	K	K	K	M
6,800pF (682)	K	K	K	K	K	M
8,200pF (822)	K	K	K	K	K	M
0.010μF (103)	K	K	K	K	K	M
0.012μF (123)	K	K	K	K	M	U
0.015μF (153)	K	K	K	K	M	U
0.018μF (183)	K	K	K	K	M	U
0.022μF (223)	K	K	K	K	M	
0.027μF (273)	K	K	K	K	U	
0.033μF (333)	K	K	K	K	U	
0.039μF (393)	K	K	K	K	U	
0.047μF (473)	K	K	K	K	U	
0.056μF (563)	K	K	K	K		
0.068μF (683)	K	K	K	K		
0.082μF (823)	K	K	K	M		
0.10μF (104)	K	K	K	M		
0.12μF (124)	K	K	K			
0.15μF (154)	K	K	K			

MULTILAYER CERAMIC CHIP CAPACITORS SH SERIES

CAPACITANCE RANGE – X7R DIELECTRIC 1825 SIZES

Table 4-Q

Size	1825					
VDC (V)	250	500	630	1000	2000	3000
0.18μF (184)	K	K	K			
0.22μF (224)	K	K	K			
0.27μF (274)	K	K	K			
0.33μF (334)	K	K	K			
0.39μF (394)	K	K	K			
0.47μF (474)	K	K	K			
0.56μF (564)	K	M	M			
0.68μF (684)	K					
0.82μF (824)	K					
1.0μF (105)	K					

MULTILAYER CERAMIC CHIP CAPACITORS SH SERIES

CAPACITANCE RANGE – X7R DIELECTRIC 2220 SIZES

Table 4-R

Size	2220									
VDC (V)	25	50	100	250	500	630	1000	1500	2000	3000
1,000pF (102)	K	K	K	K	K	K	K	K	K	K
1,200pF (122)	K	K	K	K	K	K	K	K	K	K
1,500pF (152)	K	K	K	K	K	K	K	K	K	K
1,800pF (182)	K	K	K	K	K	K	K	K	K	K
2,200pF (222)	K	K	K	K	K	K	K	K	K	K
2,700pF (272)	K	K	K	K	K	K	K	K	K	K
3,300pF (332)	K	K	K	K	K	K	K	K	K	K
3,900pF (392)	K	K	K	K	K	K	K	K	K	K
4,700pF (472)	K	K	K	K	K	K	K	K	K	K
5,600pF (562)	K	K	K	K	K	K	K	K	K	K
6,800pF (682)	K	K	K	K	K	K	K	K	K	M
8,200pF (822)	K	K	K	K	K	K	K	M	M	M
0.010μF (103)	K	K	K	K	K	K	K	M	M	M
0.012μF (123)	K	K	K	K	K	K	K	M	M	U
0.015μF (153)	K	K	K	K	K	K	K	M	M	U
0.018μF (183)	K	K	K	K	K	K	K	U	U	U
0.022μF (223)	K	K	K	K	K	K	K	U	U	
0.027μF (273)	K	K	K	K	K	K	K	U	U	
0.033μF (333)	K	K	K	K	K	K	K	U	U	
0.039μF (393)	K	K	K	K	K	K	K	U	U	
0.047μF (473)	K	K	K	K	K	K	K	U	U	
0.056μF (563)	K	K	K	K	K	K	K	U	U	
0.068μF (683)	K	K	K	K	K	K	K			
0.082μF (823)	K	K	K	K	K	K	K			
0.10μF (104)	K	K	K	K	K	K	K			
0.12μF (124)	K	K	K	K	K	K	M			
0.15μF (154)		K	K	K	K	K	U			

MULTILAYER CERAMIC CHIP CAPACITORS SH SERIES

CAPACITANCE RANGE – X7R DIELECTRIC 2220 SIZES

Table 4-S

Size	2220									
VDC (V)	25	50	100	250	500	630	1000	1500	2000	3000
0.18μF (184)	K	K	K	K	K	K	U			
0.22μF (224)	K	K	K	K	K	K	U			
0.27μF (274)	K	K	K	K	K	K				
0.33μF (334)	K	K	K	K	K	K				
0.39μF (394)	K	K	K	K	K	K				
0.47μF (474)	K	K	K	K	K	K				
0.56μF (564)	K	K	K	K	M	M				
0.68μF (684)	K	K	K	K	M	M				
0.82μF (824)	K	K	K	K	U	U				
1.0μF (105)	K	K	K	K	U	U				
1.5μF (155)	K	K	K	M						
2.2μF (225)	K	K	K	M						
3.3μF (335)		K	K							
4.7μF (475)		K	M							
6.8μF (685)		M	U							
10μF (106)		U	U							

MULTILAYER CERAMIC CHIP CAPACITORS SH SERIES

CAPACITANCE RANGE – X7R DIELECTRIC 2225 SIZES

Table 4-T

Size	2225					
VDC (V)	500	630	1000	1500	2000	3000
1,000pF (102)	K	K	K	K	K	K
1,200pF (122)	K	K	K	K	K	K
1,500pF (152)	K	K	K	K	K	K
1,800pF (182)	K	K	K	K	K	K
2,200pF (222)	K	K	K	K	K	K
2,700pF (272)	K	K	K	K	K	K
3,300pF (332)	K	K	K	K	K	K
3,900pF (392)	K	K	K	K	K	K
4,700pF (472)	K	K	K	K	K	K
5,600pF (562)	K	K	K	K	K	M
6,800pF (682)	K	K	K	K	K	M
8,200pF (822)	K	K	K	K	K	M
0.010μF (103)	K	K	K	K	K	M
0.012μF (123)	K	K	K	M	M	M
0.015μF (153)	K	K	K	M	M	M
0.018μF (183)	K	K	K	M	M	U
0.022μF (223)	K	K	K	M	M	
0.027μF (273)	K	K	K	M	M	
0.033μF (333)	K	K	K	M	M	
0.039μF (393)	K	K	K	M	U	
0.047μF (473)	K	K	K	M	U	
0.056μF (563)	K	K	K	M	U	
0.068μF (683)	K	K	K	M		
0.082μF (823)	K	K	K	M		
0.10μF (104)	K	K	K	M		
0.12μF (124)	K	K	U			
0.15μF (154)	K	K	U			

MULTILAYER CERAMIC CHIP CAPACITORS SH SERIES

CAPACITANCE RANGE – X7R DIELECTRIC 2225 SIZES

Table 4-U

Size	2225					
VDC (V)	500	630	1000	1500	2000	3000
0.18μF (184)	K	K	U			
0.22μF (224)	K	K	U			
0.27μF (274)	K	K				
0.33μF (334)	K	K				
0.39μF (394)	K	K				
0.47μF (474)	K	K				
0.56μF (564)	K	K				

CAPACITANCE RANGE – X5R DIELECTRIC 0402, 0603 SIZES

Table 5-A

Size	0402				0603					0805				
	6.3	10	16	25	6.3	10	16	25	50	6.3	10	16	25	50
0.033μF (333)			E											
0.047μF (473)			E											
0.068μF (683)		E	E											
0.10μF (104)	E	E	E	E										
0.15μF (154)	E	E	E	E										
0.22μF (224)	E	E	E	E			X	X						
0.33μF (334)	E	E			X	X	X	X						
0.47μF (474)	E	E				X	X	X						
0.68μF (684)	E	E			X	X	X	X						
1.0μF (105)					X	X	X	X						
1.5μF (155)					X					I	I	I	I	
2.2μF (225)					X	X	X			I	I	I	I	
3.3μF (335)					X					I	I	I	I	
4.7μF (475)					X									

MULTILAYER CERAMIC CHIP CAPACITORS SH SERIES
CAPACITANCE RANGE – X5R DIELECTRIC 1206, 1210 SIZES
Table 5-B

Size	1206					1210				
VDC (V)	6.3	10	16	25	50	6.3	10	16	25	50
1.5μF (155)		J	J				K	K		
2.2μF (225)		J	J	P			K	K		
3.3μF (335)		P	P	P						
4.7μF (475)	P	P	P	P			K	K	K	
6.8μF (685)	P	P								
10μF (106)	P	P	P	P		K	K	K		

CAPACITANCE RANGE – Y5V DIELECTRIC 0402, 0603 SIZES
Table 6-A

Size	0402					0603			
VDC (V)	6.3	10	16	25	50	10	16	25	50
0.010μF (103)		E	E	E	E	S	S	S	S
0.015μF (153)		E	E	E	E	S	S	S	S
0.022μF (223)		E	E	E	E	S	S	S	S
0.033μF (333)		E	E	E	E	S	S	S	S
0.047μF (473)		E	E	E		S	S	S	S
0.068μF (683)		E	E	E		S	S	S	S
0.10μF (104)		E	E	E		S	S	S	S
0.15μF (154)		E				S	S	S	S
0.22μF (224)	E	E				S	S	S	S
0.33μF (334)	E	E				S	S	S	
0.47μF (474)						S	S		
0.68μF (684)						S	X		
1.0μF (105)						S	X		
2.2μF (225)						S			

MULTILAYER CERAMIC CHIP CAPACITORS SH SERIES
Dissipation Factor– Requirement -X7R, X5R,X6S,X7S
Table 7

Rated vol.	D.F. \leq	Exception of D.F. \leq	
$\geq 100V$	$\leq 2.5\%$	$\leq 3\%$	1206 $\geq 0.47\mu F$
		$\leq 5\%$	0603 $\geq 0.068\mu F$; 0805 $> 0.1\mu F$; 1206 $\geq 1\mu F$; 1210 $\geq 2.2\mu F$; TT series
		$\leq 10\%$	0805 $> 0.22\mu F$; 1210 $\geq 3.3\mu F$
50V	$\leq 2.5\%$	$\leq 3\%$	0201(50V); 0603 $\geq 0.047\mu F$; 0805 $\geq 0.18\mu F$; 1206 $\geq 0.47\mu F$
		$\leq 5\%$	0201 $\geq 0.01\mu F$; 1210 $\geq 3.3\mu F$
		$\leq 10\%$	0402 $\geq 0.012\mu F$; 0603 $> 0.1\mu F$; 0805 $\geq 1\mu F$ (0805/X7R $> 0.47\mu F$); 1206 $\geq 2.2\mu F$; 1210 $\geq 10\mu F$; TT series
		$\leq 12.5\%$	1206/X5R = $10\mu F$
35V	$\leq 3.5\%$	$\leq 10\%$	0603 $\geq 1\mu F$; 0805 $\geq 2.2\mu F$; 1206 $\geq 2.2\mu F$; 1210 $\geq 10\mu F$
25V	$\leq 3.5\%$	$\leq 5\%$	0201 $\geq 0.01\mu F$ (0201/X5R = $0.01\mu F$); 0805 $\geq 1\mu F$; 1210 $\geq 10\mu F^*$
		$\leq 7\%$	0603 $\geq 0.33\mu F$
		$\leq 10\%$	0201 $\geq 0.1\mu F$ (0201/X5R $> 0.01\mu F$); 0603 $\geq 0.47\mu F$; TT series; 0402 $\geq 0.10\mu F$ (0402/X7R $\geq 0.056\mu F$); 0805 $\geq 2.2\mu F$; 1206 $\geq 4.7\mu F$; 1210 $\geq 22\mu F$ (1210/X5R $\geq 10\mu F$) *
		$\leq 12.5\%$	0402 $\geq 0.47\mu F$; 0805/X5R/X6S = $10\mu F$
16V	$\leq 3.5\%$	$\leq 5\%$	0201 $\geq 0.01\mu F$ (0201/X5R = $0.01\mu F$); 0402 $\geq 0.033\mu F$; 0603 $\geq 0.15\mu F$; 0805 $\geq 0.68\mu F$; 1206 $\geq 2.2\mu F$; 1210 $\geq 4.7\mu F$
		$\leq 10\%$	0201 $\geq 0.1\mu F$ (0201/X5R $> 0.01\mu F$; 0201/X7R $\geq 0.022\mu F$); 0402 $\geq 0.22\mu F$; 0603 $> 0.47\mu F$; 0805 $\geq 2.2\mu F$; 1206 $\geq 4.7\mu F$; 1210 $\geq 22\mu F$; TT series
		$\leq 12.5\%$	0402/X5R $\geq 1\mu F$; 0402/X6S = $1\mu F$; 0805/X5R/X6S = $10\mu F$
10V	$\leq 5.0\%$	$\leq 10\%$	0201 $\geq 0.012\mu F$; 0402 $\geq 0.22\mu F$; 0603 $\geq 0.33\mu F$; TT series; 0805 $\geq 2.2\mu F$; 1206 $\geq 2.2\mu F$; 1210 $\geq 22\mu F$; 01R5/X5R
		$\leq 12.5\%$	0805/X5R/X6S = $10\mu F$
		$\leq 15\%$	0201 $\geq 0.1\mu F$ (0201/X5R $> 0.1\mu F$); 0402 $\geq 1\mu F$; 0603/X5R $\geq 10\mu F$
6.3V	$\leq 10\%$	$\leq 15\%$	0201 $\geq 0.1\mu F$ (0201/X5R $> 0.1\mu F$); 0402 $\geq 1\mu F$ (0402/X6S $\geq 0.47\mu F$); 0603 $\geq 10\mu F$; 0805 $\geq 4.7\mu F$; 1206 $\geq 47\mu F$; 1210 $\geq 100\mu F$; TT series
		$\leq 20\%$	0402 $\geq 2.2\mu F$
4V	$\leq 15\%$	-	-

MULTILAYER CERAMIC CHIP CAPACITORS SH SERIES
**Humidity (Damp Heat) Steady State, (Damp Heat) Load and High Temperature Load
- Requirement-X7R, X5R, X6S, X7S:**
Table 8

Rated vol.	D.F. ≤	Exception of D.F. ≤	
≥100V	≤ 3%	≤ 6%	1206 ≥ 0.47μF
		≤ 7.5%	0603 ≥ 0.068μF; 0805 > 0.1μF; 1206 ≥ 1μF; 1210 ≥ 2.2μF; TT series
		≤ 20%	0805 > 0.22μF; 1210 ≥ 3.3μF
50V	≤ 3%	≤ 6%	0201(50V); 0603 ≥ 0.047μF; 0805 ≥ 0.18μF; 1206 ≥ 0.47μF
		≤ 10%	0201 ≥ 0.01μF; 1210 ≥ 3.3μF
		≤ 20%	0402 ≥ 0.012μF; 0603 > 0.1μF; 0805 ≥ 1μF (0805/X7R > 0.47μF); 1206 ≥ 2.2μF; 1210 ≥ 10μF; TT series
35V	≤ 5%	≤ 20%	0603 ≥ 1μF; 0805 ≥ 2.2μF; 1206 ≥ 2.2μF; 1210 ≥ 10μF
25V	≤ 5%	≤ 10%	0201 ≥ 0.01μF (0201/X5R = 0.01μF); 0805 ≥ 1μF; 1210 ≥ 10μF*
		≤ 14%	0603 ≥ 0.33μF
		≤ 15%	0201 ≥ 0.1μF (0201/X5R > 0.01μF); 0603 ≥ 0.47μF; TT series; 0402 ≥ 0.10μF (0402/X7R ≥ 0.056μF); 0805 ≥ 2.2μF; 1206 ≥ 4.7μF; 1210 ≥ 22μF (1210/X5R ≥ 10μF) *
		≤ 20%	0402 ≥ 0.47μF;
16V	≤ 5%	≤ 10%	0603 ≥ 0.15μF; 0805 ≥ 0.68μF; 1206 ≥ 2.2μF; 1210 ≥ 4.7μF
		≤ 15%	0201 ≥ 0.01μF (0201/X7R ≥ 0.022μF); 0402 ≥ 0.033μF; 0603 > 0.47μF; 0805 ≥ 2.2μF; 1206 ≥ 4.7μF; 1210 ≥ 22μF; TT series
10V	≤ 7.5%	≤ 15%	0201 ≥ 0.012μF; 0402 ≥ 0.22μF; 0603 ≥ 0.33μF; 0805 ≥ 2.2μF; 1206 ≥ 2.2μF; 1210 ≥ 22μF
		≤ 20%	0201 ≥ 0.1μF; 0402 ≥ 1μF; 0603/X5R ≥ 10μF; TT series; 01R5/X5R
6.3V	≤ 15%	≤ 30%	0201 ≥ 0.1μF; 0402 ≥ 1μF (0402/X6S ≥ 0.47μF); 0603 ≥ 10μF; 0805 ≥ 4.7μF; 1206 ≥ 47μF; 1210 ≥ 100μF; TT series
4V	≤ 20%	-	-

MULTILAYER CERAMIC CHIP CAPACITORS SH SERIES

Dissipation Factor– Requirement - Y5V

Table 9

Rated vol.	D.F. ≤	Exception of D.F. ≤	
≥50V	≤5%	≤7%	0603≥0.1μF; 0805≥0.47μF; 1206≥4.7μF; TT series
		≤12.5%	1210≥6.8μF
35V	≤7%	-	-
25V	≤5%	≤7%	0402≥0.047μF; 0603≥0.1μF; 0805≥0.33μF; 1206≥1μF; 1210≥4.7μF
		≤9%	0402≥0.068μF; 0603≥0.47μF; 1206≥4.7μF; 1210≥22μF; TT series
16V (C<1.0μF)	≤7%	≤9%	0402≥0.068μF; 0603≥0.68μF
		≤12.5%	0402≥0.22μF
16V (C≥1.0μF)	≤9%	≤12.5%	0603≥2.2μF; 0805≥3.3μF; 1206≥10μF; 1210≥22μF; 1812≥47μF; TT series
10V	≤12.5%	≤20%	0402≥0.47μF
6.3V	≤20%	-	-

MULTILAYER CERAMIC CHIP CAPACITORS SH SERIES

Humidity (Damp Heat) Steady State, (Damp Heat) Load and High Temperature Load - Requirement - Y5V

Table 10

Rated vol.	D.F. \leq	Exception of D.F. \leq	
$\geq 50V$	$\leq 7.5\%$	$\leq 10\%$	0603 $\geq 0.1\mu F$; 0805 $\geq 0.47\mu F$; 1206 $\geq 4.7\mu F$
		$\leq 20\%$	1210 $\geq 6.8\mu F$
35V	$\leq 10\%$	-	-
25V	$\leq 7.5\%$	$\leq 10\%$	0402 $\geq 0.047\mu F$; 0603 $\geq 0.1\mu F$; 0805 $\geq 0.33\mu F$; 1206 $\geq 1\mu F$; 1210 $\geq 4.7\mu F$
		$\leq 15\%$	0402 $\geq 0.068\mu F$; 0603 $\geq 0.47\mu F$; 1206 $\geq 4.7\mu F$; 1210 $\geq 22\mu F$
16V (C<1.0 μF)	$\leq 10\%$	$\leq 12.5\%$	0402 $\geq 0.068\mu F$; 0603 $\geq 0.68\mu F$
		$\leq 20\%$	0402 $\geq 0.22\mu F$
16V (C $\geq 1.0\mu F$)	$\leq 12.5\%$	$\leq 20\%$	0603 $\geq 2.2\mu F$; 0805 $\geq 3.3\mu F$; 1206 $\geq 10\mu F$; 1210 $\geq 22\mu F$; 1812 $\geq 47\mu F$
10V	$\leq 20\%$	$\leq 30\%$	0402 $\geq 0.47\mu F$
6.3V	$\leq 30\%$	-	-

MULTILAYER CERAMIC CHIP CAPACITORS SH SERIES

INSULATION RESISTANCE – Requirement - Class II (X7R, X7E, X5R,X6S,X7S,Y5V:)

Table 11

Rated Voltage	IR
100V: All X7R	10GΩ or $RxC \geq 100 \Omega \cdot F$ whichever is smaller
50V: 0402 > 0.01μF; 0603 $\geq 1\mu F$; 0805 $\geq 1\mu F$; 1206 $\geq 4.7\mu F$; 1210 $\geq 4.7\mu F$	
35V: 0805 $\geq 2.2\mu F$; 1206 $\geq 2.2\mu F$; 1210 $\geq 10\mu F$	
25V: 0402 $\geq 1\mu F$; 0603 $\geq 2.2\mu F$; 0805 $\geq 2.2\mu F$; 1206 $\geq 10\mu F$; 1210 $\geq 10\mu F$	
16V: 0201 $\geq 0.1\mu F$; 0402 $\geq 0.22\mu F$; 0603 $\geq 1\mu F$; 0805 $\geq 2.2\mu F$; 1206 $\geq 10\mu F$; 1210 $\geq 47\mu F$	
10V: 0201 $\geq 47nF$; 0402 $\geq 0.47\mu F$; 0603 $\geq 0.47\mu F$; 0805 $\geq 2.2\mu F$; 1206 $\geq 4.7\mu F$; 1210 $\geq 47\mu F$	
6.3V ; 4V ; TT series; Size ≥ 1812	
All X6S items, All X7S items	
100V: 1210 $\geq 3.3\mu F$	
50V: 0402 $\geq 0.1\mu F$; 0603 $\geq 2.2\mu F$; 0805 $\geq 10\mu F$; 1206 $\geq 10\mu F$	
35V: 0603 $\geq 1\mu F$	
25V: 0201 $\geq 0.1\mu F$; 0402 $\geq 0.22\mu F$; 0603 $\geq 10\mu F$; 0805 $\geq 10\mu F$; 1206 $\geq 22\mu F$	
16V: 0201 $\geq 0.22\mu F$; 0402 $\geq 1\mu F$; 0603 $\geq 10\mu F$	
10V: 0201 > 0.1μF; 0402 $\geq 1\mu F$; 0603 $\geq 10\mu F$; 0805 $\geq 47\mu F$; TT21 > 4.7μF	
6.3V: 0201 $\geq 0.1\mu F$; 0402 $\geq 1\mu F$; 0603 > 4.7μF; 0805 $\geq 47\mu F$; 1206 $\geq 10\mu F$;	
4V: 0603 $\geq 22\mu F$; 0805 $\geq 47\mu F$; 1206 $\geq 100\mu F$	

MULTILAYER CERAMIC CHIP CAPACITORS SH SERIES

TEMPERATURE COEFFICIENT- Test Condition-Measurement voltage for Class II:

Table 12

Measurement Voltage	Size
Cap \leq 0.01 μ F: 0.5V; Cap. $>$ 0.01 μ F: 0.2V (*0201X104/6.3V~25V: 0.5V; 0201X224/10V: 0.5V; 0201S104/6.3V~16V: 0.3V; 0201S224/6.3V: 0.3V; 0201X105/6.3V&10V: 0.3V)	01005
Cap $<$ 0.1 μ F: 1.0V; 0.1 μ F \leq Cap.<1.0 μ F: 0.2V*; Cap. \geq 1.0 μ F: 0.1V* (*0201X104/6.3V~25V: 0.5V; 0201X224/10V: 0.5V; 0201S104/6.3V~16V: 0.3V; 0201S224/6.3V: 0.3V; 0201X105/6.3V&10V: 0.3V)	0201
Cap $<$ 0.1 μ F: 1.0V; Cap =1 μ F: 0.5V**; 0402B224-16V: 0.5V; 0402B474-10V: 0.5V; 0402X475M6R3: 0.5V; 1 μ F<Cap<10 μ F: 0.2V; **0402B105M6R3V: 0.2V; Cap \geq 10 μ F: 0.1V	0402
Cap $<$ 1.0 μ F: 1.0V; 1.0 μ F \leq Cap. \leq 4.7 μ F: 0.5V; Cap. $>$ 4.7 μ F:0.2V	0603
Cap $<$ 10 μ F: 1.0V; Cap.=10 μ F: 0.5V; 0805B475/6.3V~25V: 0.5V; Cap. $>$ 10 μ F:0.2V	0805
Cap \leq 10 μ F: 1.0V; 10 μ F<Cap. \leq 100 μ F: 0.5V; Cap. $>$ 100 μ F:0.2V	1206/1210

MULTILAYER CERAMIC CHIP CAPACITORS SH SERIES

HUMIDITY (DAMP HEAT)STEADY STATE and High Temperature Load – Requirement
 - Class II (X7R, X5R, X6S, X7S, Y5V)

Table 13

Measurement Voltage	IR
100V: X7R; 1210 \geq 3.3 μ F	1G Ω or Rx $C \geq$ 10 Ω -F whichever is smaller
50V: 0402 $>$ 0.01 μ F; 0603 \geq 1 μ F; 0805 \geq 1 μ F; 1206 \geq 4.7 μ F; 1210 \geq 4.7 μ F	
35V:0603 \geq 1 μ F;0805 \geq 2.2 μ F; 1206 \geq 2.2 μ F;1210 \geq 10 μ F	
25V: 0201 \geq 0.1 μ F; 0402 \geq 0.22 μ F; 0603 \geq 2.2 μ F; 0805 \geq 2.2 μ F; 1206 \geq 10 μ F; 1210 \geq 10 μ F	
16V: 0201 \geq 0.1 μ F; 0402 \geq 0.22 μ F; 0603 \geq 1 μ F ;0805 \geq 2.2 μ F; 1206 \geq 10 μ F; 1210 \geq 47 μ F	
10V: 0201 \geq 47nF; 0402 \geq 0.47 μ F; 0603 \geq 0.47 μ F; 0805 \geq 2.2 μ F; 1206 \geq 4.7 μ F; 1210 \geq 47 μ F	
6.3V; 4V; TT series ; All X6S/X7S items; Size \geq 1812	

MULTILAYER CERAMIC CHIP CAPACITORS SH SERIES

HUMIDITY (DAMP HEAT) Load– Requirement - Class II (X7R, X5R, X6S, X7S, Y5V)

Table 14

Measurement Voltage	IR
100V: X7R; 1210 \geq 3.3 μ F	500M Ω or $RxC \geq 5 \Omega \cdot F$ whichever is smaller.
50V: 0402 $>$ 0.01 μ F; 0603 \geq 1 μ F; 0805 \geq 1 μ F; 1206 \geq 4.7 μ F; 1210 \geq 4.7 μ F	
35V:0603 \geq 1 μ F;0805 \geq 2.2 μ F; 1206 \geq 2.2 μ F;1210 \geq 10 μ F	
25V: 0201 \geq 0.1 μ F; 0402 \geq 0.22 μ F; 0603 \geq 2.2 μ F; 0805 \geq 2.2 μ F; 1206 \geq 10 μ F; 1210 \geq 10 μ F	
16V: 0201 \geq 0.1 μ F; 0402 \geq 0.22 μ F; 0603 \geq 1 μ F ;0805 \geq 2.2 μ F; 1206 \geq 10 μ F; 1210 \geq 47 μ F	
10V: 0201 \geq 47nF; 0402 \geq 0.47 μ F; 0603 \geq 0.47 μ F; 0805 \geq 2.2 μ F; 1206 \geq 4.7 μ F; 1210 \geq 47 μ F	
6.3V; 4V; TT series ; All X6S/X7S items; Size \geq 1812	

MULTILAYER CERAMIC CHIP CAPACITORS SH SERIES

HIGH TEMPERATURE LOAD (ENDURANCE)– Test Condition-100% of Rated Voltage

Table 15

Size	Dielectric	Rated Voltage	Capacitance
0201	X5R/X7R/X6S/X7S	≤10V	C≥0.1μF
		≥16V	C>0.1μF
0402	X5R	≤16V	C>1.0μF
		25V,50V	C≥1.0μF
	X6S	6.3V,10V	C>1.0μF
		16V,25V	C≥1.0μF
X7R/X7S/Y5V	6.3V,10V	C≥1.0μF	
0603	X5R/X7R/X6S/X7S	4V	C≥22μF
		6.3V,10V	C≥4.7μF
	X5R/X6S/X7S	25V	C≥1.0μF
	X7R	35V	C≥1.0μF
0805	X5R/X7R/X6S/X7S	4V	C≥47μF
		6.3V	C≥22μF
		10V, 50V	C≥10μF
	X6S	16V	C>10μF
		25V	C≥10μF
	X7R/X7S	16V, 25V	C≥10μF
	X5R		C≥22μF
1206	X5R/X7R/X6S	≤6.3V	C≥47μF
1210	X5R/X7R/X6S	16V	C≥47μF
	X7R	100V	C≥3.3μF

MULTILAYER CERAMIC CHIP CAPACITORS SH SERIES

HIGH TEMPERATURE LOAD (ENDURANCE)– Test Condition-150% of Rated Voltage

Table 16

Dielectric	Rated Voltage	Capacitance	Dielectric
0201	X5R/X6S	16V, 25V	C= 0.1μF
	X7R	16V	C≥0.022μF
0402	X5R/X7R/X6S	50V	C>0.01μF
		10-25V	C≥0.22μF
	Y5V	16V	C≥0.47μF
0603	Y7S	50V~100V	C>0.22μF
	X7R	50V	C>0.1μF
		25V	C=1.0μF
	X5R	50V	C≥1.0μF
	X5R/X7R/X6S/X7S	10V, 16V	C≥1.0μF
Y5V	16V	C≥0.22μF	
0805	X5R/X7R/X6S/X7S	100V	C≥0.47μF
		50V	C≥0.68μF
		35V	C≥2.2μF
		10-25V	C≥4.7μF
	Y5V	16V	C≥4.7μF
1206	X7R	100V	C≥1.0μF
		50V	C≥2.2μF
	X5R/X6S/X7S	100V	C>1.0μF
		50V	C=4.7μF
1210	X5R/X7R/X6S/X7S	50-100V	C≥2.2μF
1825, 2220,2225	X7R	100V-250V	C≥1.0μF

MULTILAYER CERAMIC CHIP CAPACITORS SH SERIES
RELIABILITY TEST CONDITIONS AND REQUIREMENTS

Item	Test Condition	Requirements
Visual and Mechanical	-	* No remarkable defect. * Dimensions to conform to individual spec. sheet.
Capacitance	Class I: (NP0) $\leq 1000\text{pF}$, $1.0 \pm 0.2\text{Vrms}$, $1\text{MHz} \pm 10\%$ $> 1000\text{pF}$, $1.0 \pm 0.2\text{Vrms}$, $1\text{KHz} \pm 10\%$ Class II: (X7R, X6S, X5R, Y5V) $C \leq 10\mu\text{F}$, $1.0 \pm 0.2\text{Vrms}$, $1\text{KHz} \pm 10\%$ ** $C > 10\mu\text{F}$, $0.5 \pm 0.2\text{Vrms}$, $120\text{Hz} \pm 20\%$ ** Test condition: $0.5 \pm 0.2\text{Vrms}$, $1\text{KHz} \pm 10\%$ X7R: 0603/475(6.3V) X5R: 0201 ≥ 224 (6.3V,10V,16V) #1, 0402 ≥ 475 (6.3V,16V), 0402 ≥ 225 (10V), 0603=106 (6.3V) TT18X ≥ 475 (10V) , TT15X series X6S: 0201/474(4V), 0201 > 104 (6.3V,10V) , 0402 ≥ 225 (6.3V), 0402/475 (10V), 0603/106 (6.3V), * Excluding X5R/0201/105(6.3V); 225(10V), 0402X475M6R3 ($1.0 \pm 0.2\text{Vrms}$, $1\text{KHz} \pm 10\%$) * Before initial measurement (Class II only): To apply de-aging at 150°C for 1hr for 24 ± 2 hrs at room temp.	* Shall not exceed the limits given in the detailed spec. NP0: Cap $\geq 30\text{pF}$, $Q \geq 1000$; Cap $< 30\text{pF}$, $Q \geq 400 + 20C$ X7R, X5R, X6S, X7S: <i>See <Table 7></i> Y5V: <i>See <Table 9></i>
Q/D.F (Dissipation Factor)		
Dielectric Strength	*To apply voltage: $\leq 100\text{V}$: 250% of rated voltage. 200V ~ 300V: 200% of rated voltage. 400V ~ 450V: 120% of rated voltage. 500V ~ 999V: 150% of rated voltage. 1000V ~ 3000V: 120% of rated voltage. 4000V: 110% of rated voltage. *Duration: 1 to 5 sec. *Charge & discharge current less than 50mA.	* No evidence of damage or flash over during test.

MULTILAYER CERAMIC CHIP CAPACITORS SH SERIES
RELIABILITY TEST CONDITIONS AND REQUIREMENTS

Item	Test Condition	Requirements
Temperature Coefficient	<p>With no electrical load. @Operating Temp. Range NP0/X7R/X7S: @ -55~125° C at 25° C; X5R: -55~ 85° C at 25° C; X6S: -55~105° C at 25° C; Y5V: -25~ 85° C at 20° C</p> <p>* Before initial measurement (Class II only): To apply de-aging at 150° C for 1hr then set for 24 ± 2 hrs at room temp.</p> <p>* Measurement voltage for Class II: See <Table 12></p>	<p>NP0: Within ± 30ppm/° C X7R: Within ± 15% X7S: Within ± 22% X5R: Within ± 15% X6S: Within ± 22% Y5V: : Within +30%/-80%</p>
Adhesive Strength of Termination	<p>*Pressurizing force: 2N (0201) and 5N (≤0603) and 10N (>0603);</p> <p>* Test time: 10 ± 1 sec.</p>	<p>* No remarkable damage or removal of the terminations.</p>
Vibration Resistance	<p>Vibration frequency: 10~55 Hz/min.</p> <p>* Total amplitude: 1.5mm</p> <p>* Test time: 6 hrs. (Two hrs each in three mutually perpendicular directions.)</p> <p>* Before initial measurement (Class II only): To apply de-aging at 150° C for 1hr then set for 24 ± 2 hrs at room temp. * Cap./DF(Q) Measurement to be made after de-aging a 150° C for 1hr then set for 24 ± 2 hrs at room temp.</p>	<p>* No remarkable damage.</p> <p>* Cap change and Q/D.F.: To meet initial spec.</p>
Bending Test	<p>* The middle part of substrate shall be pressurized by means of the pressurizing rod at a rate of about 1 mm per second until the deflection becomes 5 mm and then the pressure shall be maintained for 5 ± 1 sec.</p> <p>*Before initial measurement (Class II only): To apply de-aging at 150° C for 1hr then set for 24 ± 2 hrs at room temp.</p> <p>Measurement to be made after keeping at room temp. for 24 ± 2 hrs.</p>	<p>* No remarkable damage.</p> <p>* Cap change: NP0: within ± 5% or 0.5pF whichever is larger; X7R, X5R, X6S, X7S: within ± 12.5%; Y5V: within ± 30% (This capacitance change means the change of capacitance under specified flexure of substrate from the capacitance measured before the test.)</p>

MULTILAYER CERAMIC CHIP CAPACITORS SH SERIES

RELIABILITY TEST CONDITIONS AND REQUIREMENTS

Item	Test Condition	Requirements
<p>Resistance to Soldering Heat</p>	<ul style="list-style-type: none"> * Solder temperature: $260 \pm 5^{\circ} \text{C}$ * Dipping time: $10 \pm 1 \text{ sec}$ * Preheating: $120 \text{ to } 150^{\circ} \text{C}$ for 1 minute before immerse the capacitor in a eutectic solder. * Before initial measurement (Class II only): To apply de-aging at 150°C for 1hr then set for $24 \pm 2 \text{ hrs}$ at room temp. * Cap. / DF(Q) / I.R. Measurement to be made after de-aging at 150°C for 1hr then set for $24 \pm 2 \text{ hrs}$ at room 	<ul style="list-style-type: none"> * No remarkable damage. * Cap change: NP0: within $\pm 2.5\%$ or 0.25pF whichever is larger X7R, X5R, X6S, X7S: within $\pm 7.5\%$ Y5V: within $\pm 20\%$ * Q/D.F., I.R. and dielectric strength: To meet initial requirements. * 25% max. leaching on each edge.
<p>Temperature Cycle</p>	<ul style="list-style-type: none"> *Conduct the five cycles according to the temperatures and time. Time (min.): $30 \pm 3 @ \text{Min. operating temp.} +0/-3^{\circ} \text{C}$ Time (min.): $2 \sim 3 @ \text{Room temperture}$ Time (min.): $30 \pm 3 @ \text{Max. operating temp.} +3/-0^{\circ} \text{C}$ Time (min.): $2 \sim 3 @ \text{Room temperture}$ * Before initial measurement (Class II only): Perform 150°C for 1 hr and then set for $24 \pm 2 \text{ hrs}$ at room temp. * Cap. / DF(Q) / I.R. Measurement to be made after de-aging at 150°C for 1hr then set for $24 \pm 2 \text{ hrs}$ at room. 	<ul style="list-style-type: none"> * No remarkable damage. * Cap change: NP0: within $\pm 2.5\%$ or 0.25pF whichever is larger X7R, X5R, X6S, X7S: within $\pm 7.5\%$ Y5V: within $\pm 20\%$ * Q/D.F., I.R. and dielectric strength: To meet initial requirements.
<p>Solder ability</p>	<ul style="list-style-type: none"> * Solder temperature: $235 \pm 5^{\circ} \text{C}$ * Dipping time: $2 \pm 0.5 \text{ sec}$. 	<p>75% min. coverage of all metalized area</p>

MULTILAYER CERAMIC CHIP CAPACITORS SH SERIES

RELIABILITY TEST CONDITIONS AND REQUIREMENTS

Item	Test Condition	Requirements
<p>Humidity (Damp Heat) Steady State</p>	<p>* Test temp.: $40 \pm 2^\circ \text{C}$ * Humidity: 90~95% RH * Test time: 500+24/-0hrs. * Before initial measurement (Class II only): To apply de-aging at 150°C for 1hr then set for 24 ± 2 hrs at room temp. * Cap. / DF(Q) / I.R. Measurement to be made after de-aging at 150°C for 1hr then set for 24 ± 2 hrs at room temp.</p>	<p>* No remarkable damage. * Cap change: NP0: within $\pm 5\%$ or 0.5pF whichever is larger X7R, X5R, X6S, X7S: $\geq 10V^{**}$, within $\pm 12.5\%$; $\leq 6.3V$ within $\pm 25\%$; TT series & $C \geq 1\mu\text{F}$, within $\pm 25\%$ ** 10V: 0603 $\geq 4.7\mu\text{F}$; 0402 $\geq 1\mu\text{F}$; 0201 $\geq 0.1\mu\text{F}$, within $\pm 25\%$; Y5V: $\geq 10V$, within $\pm 30\%$; $\leq 6.3V$, within +30/-40% * Q/D.F. value: NP0: More than 30pF $Q \geq 350$, $10\text{pF} \leq C \leq 30\text{pF}$, $Q \geq 275 + 2.5C$ Less than 10pF $Q \geq 200 + 10C$ X7R, X5R, X6S, X7S: See <Table 8> Y5V: See <Table 10> *I.R.: $\geq 10V$, $1G\Omega$ or $50 \Omega\text{-F}$ whichever is smaller. Class II (X7R, X5R, X6S, X7S, Y5V) See <Table 13></p>
<p>Insulation Resistance</p>	<p>*Test temp.: Room Temperature. *To apply rated voltage for MAX. 120sec. Rated voltage: 200~630V: To apply rated voltage (500V max.) for 60 sec. Rated voltage: >630V: To apply 500V for 60 sec</p>	<p>Class I: (NP0) $10G\Omega$ or $RxC \geq 500\Omega\text{-F}$ whichever is smaller. Class II (X7R, X7E, X5R, X6S, X7S, Y5V:) $\geq 10G\Omega$ or $RxC \geq 100\Omega\text{-F}$ whichever is smaller. See <Table 11></p>

MULTILAYER CERAMIC CHIP CAPACITORS SH SERIES

RELIABILITY TEST CONDITIONS AND REQUIREMENTS

Item	Test Condition	Requirements
Humidity (Damp Heat) Load	<ul style="list-style-type: none"> *Test temp.: $40 \pm 2^\circ \text{C}$ * Humidity: 90~95%RH * Test time: 500+24/-0 hrs. * To apply voltage: Rated voltage (MAX. 500V) *Before initial measurement (Class II only): To apply de-aging at 150°C for 1hr then set for 24 ± 2 hrs at room temp. * Cap. / DF(Q) / I.R. Measurement to be made after de-aging at 150°C for 1hr then set for 24 ± 2 hrs at room temp. 	<ul style="list-style-type: none"> * No remarkable damage. Cap change: NP0: $\pm 7.5\%$ or 0.75pF whichever is larger. X7R, X5R, X6S, X7S: $\geq 10V^{**}$, within $\pm 12.5\%$; $\leq 6.3V$ within $\pm 25\%$; TT series & $C \geq 1\mu\text{F}$, within $\pm 25\%$ **10V: 0603 $4.7 \geq \mu\text{F}$; 0402 $\geq 1\mu\text{F}$; 0201 $\geq 0.1 \mu\text{F}$, within $\pm 25\%$; Y5V: $\geq 10V$, within $\pm 30\%$; $\leq 6.3V$, within +30/-40% Q/D.F. value: NP0: $C \geq 30\text{pF}$, $Q \geq 200$; $C < 30\text{pF}$, $Q \geq 100 + 10/3C$ X7R, X5R, X6S, X7S: See <Table 8> Y5V: See <Table 10> * I.R.: $\geq 10V$, $500M\Omega$ or $25 \Omega\text{-F}$ whichever is smaller. Class II (X7R, X5R, X6S, X7S, Y5V) See <Table 14>

MULTILAYER CERAMIC CHIP CAPACITORS SH SERIES

RELIABILITY TEST CONDITIONS AND REQUIREMENTS

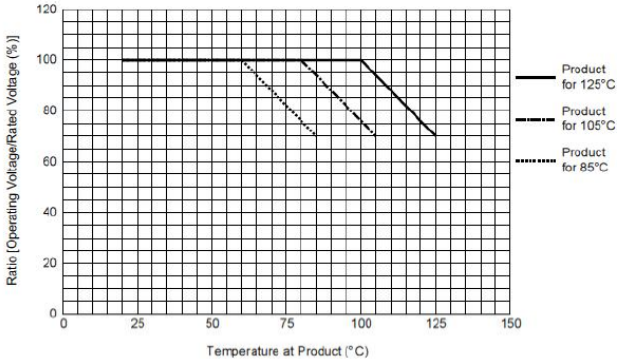
Item	Test Condition	Requirements
<p>High Temperature Load (Endurance)</p>	<p>Test temp.: NP0, X7R/X7E/X7S: $125 \pm 3^\circ \text{C}$ X6S: $105 \pm 3^\circ \text{C}$ X5R, Y5V: $85 \pm 3^\circ \text{C}$</p> <p>* Test time: 1000+24/-0 hrs.</p> <p>* To apply voltage:</p> <p>(1) 100% of rated voltage for below range <i>See <Table 15></i></p> <p>**1WV items must follow de-rating conditions.</p> <p>(2) 150% of rated voltage for below range. <i>See <Table 16></i></p> <p>(3) $\leq 6.3\text{V}$ or $C \geq 10\mu\text{F}$: 150% of rated voltage. (4) 10V~250V: 200% of rated voltage. (5) 400V~450V: 120% of rated voltage. (6) 500V: 150% of rated voltage. (7) 630V~3000V: 120% of rated voltage. (8) 4000V: 110% of rated voltage</p> <p>*Before initial measurement (Class II only): To apply de-aging at 150°C for 1hr then set for 24 ± 2 hrs at room temp.</p> <p>* Cap. / DF(Q) / I.R. Measurement to be made after de-aging at 150°C for 1hr then set for 24 ± 2 hrs at room temp.</p> <p>** De-rating conditions:</p> 	<p>* No remarkable damage. Cap change:</p> <p>NP0: $\pm 3.0\%$ or $\pm 0.3\text{pF}$ whichever is larger</p> <p>X7R, X5R, X6S, X7S: $\geq 10\text{V}^{**}$, within $\pm 12.5\%$; $\leq 6.3\text{V}$ within $\pm 25\%$; TT series & $C \geq 1\mu\text{F}$, within $\pm 25\%$</p> <p>** 10V: 0603 $\geq 4.7\mu\text{F}$; 0402 $\geq 1\mu\text{F}$; 0201 $\geq 0.1\mu\text{F}$, within $\pm 25\%$;</p> <p>Y5V: $\geq 10\text{V}$, within $\pm 30\%$; $\leq 6.3\text{V}$, within $+30/-40\%$</p> <p>Q/D.F. value:</p> <p>NP0: More than 30pF, $Q \geq 350$ $10\text{pF} \leq C < 30\text{pF}$, $Q \geq 275 + 2.5C$ Less than 10pF, $Q \geq 200 + 10C$</p> <p>X7R, X5R, X6S, X7S <i>See <Table 8></i></p> <p>Y5V: <i>See <Table 10></i></p> <p>*I.R.: $\geq 10\text{V}$, 1GΩ or 50Ω-F whichever is smaller. Class II (X7R, X5R, X6S, X7S, Y5V) <i>See <Table 13></i></p>

MULTILAYER CERAMIC CHIP CAPACITORS SH SERIES

RECOMMENDED PROFILE CONDITIONS

The lead-free termination MLCCs are not only to be used on SMT against lead-free solder paste, but also suitable against lead-containing solder paste.

If the optimized solder joint is requested, increasing soldering time, temperature and concentration of N2 within oven are recommended.

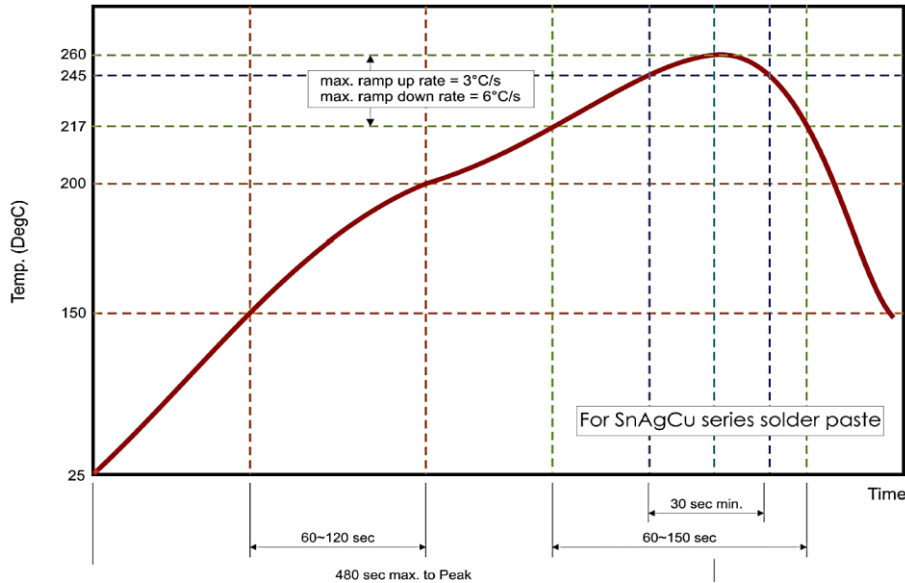

Reflow Soldering Profile For SMT Process with SnAgCu series Solder Paste

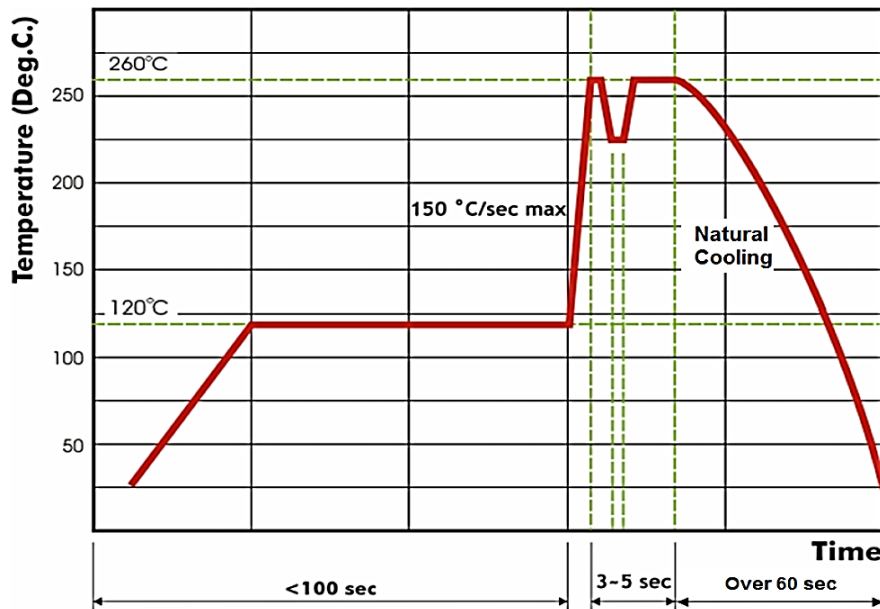

Wave Soldering Profile For SMT Process with SnAgCu series Solder Paste

MULTILAYER CERAMIC CHIP CAPACITORS SH SERIES
PACKAGING STYLE AND QUANTITY

Size	Thickness (Symbol)		Paper Tape		Plastic Tape	
			7" Reel	13" Reel	7" Reel	13" Reel
0402 (1005)	0.50±0.20	E	10,000			
0603 (1608)	0.80±0.07	S	4,000	15,000		
	0.80±0.30	X	4,000	15,000		
0805 (2012)	0.60±0.10	A	4,000	15,000		
	0.85±0.10	B	4,000	15,000		
	1.25±0.10	D			3,000	10,000
	1.25±0.30	I			3,000	10,000
1206 (3216)	0.85±0.10	B	4,000	15,000		
	0.95±0.10	C			3,000	10,000
	1.15±0.15	J			3,000	10,000
	1.25±0.10	D			3,000	10,000
	1.60±0.20	G			2,000	10,000
	1.60±0.50	P			2,000	9,000
1210 (3225)	0.95±0.10	C			3,000	10,000
	1.25±0.10	D			3,000	10,000
	1.60±0.20	G			2,000	
	2.00±0.20	K			1,000	6,000
	2.50±0.50	M			1,000	6,000
1808 (4520)	1.25±0.10	D			3,000	10,000
	1.60±0.20	G			2,000	
	2.00±0.20	K			1,000	6,000
	2.50±0.50	M			1,000	6,000
1812 (4532)	1.25±0.10	D			1,000	5,000
	1.60±0.20	G			1,000	-
	2.00±0.20	K			1,000	-
	2.50±0.50	M			500	3,000
1812 (4532)	2.00±0.20	K			1,000	-
1825 (4563)	2.50±0.50	M			500	
2220 (5750)						
2225 (5763)						

MULTILAYER CERAMIC CHIP CAPACITORS SH SERIES

CONSTRUCTIONS

Size Code	Name	NPO	X7R, X5R, Y5V
1	Ceramic material	CaZrO3 based	BaTiO3 based
2	Inner electrode	Ni	
3	Termination	Inner layer	Cu + Ag Polymer
4		Middle layer	Ni
5		Outer layer	Sn

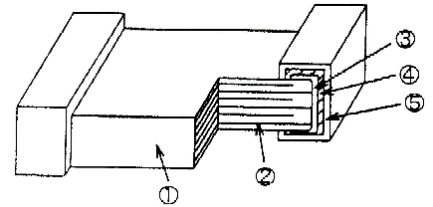

REEL DIMENSION (Unit: mm)

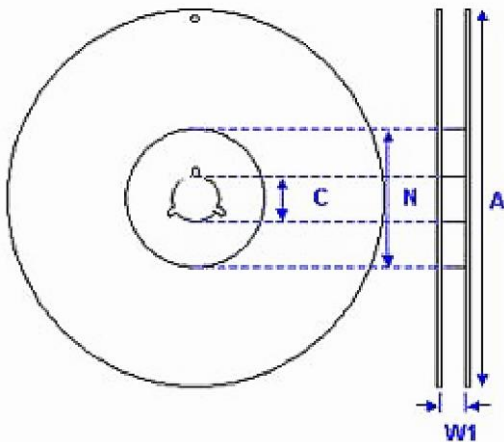

Size Code	0402, 0603, 0805, 1206, 1210			1808 to 2225
Reel Size	7"	10"	13"	7"
C	13.0±0.5	13.0±0.5	13.0±0.5	13.0±0.5
W 1	10.0±1.5	10.0±1.5	10.0±1.5	12.4+2.0/-0
A	178.0±2.0	250.0±2.0	330.0±2.0	178.0±2.0
N	60.0+1.0/-0	50 min	50 min	60.0+1.0/-0

MULTILAYER CERAMIC CHIP CAPACITORS SH SERIES

TAPE DIMENSION (Unit: mm)

Paper Tape

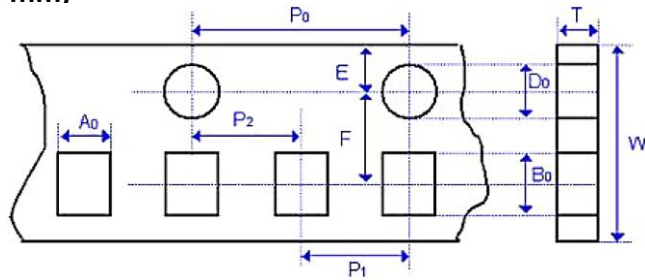

Plastic Tape

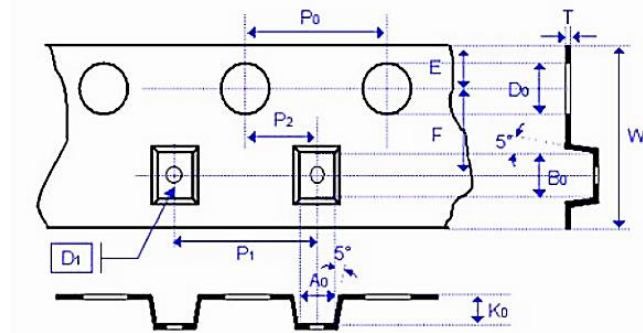

Size	0402	0603	0805		
Thickness	N,E	S,X	A, H	B, T	D, I
A0	0.70 +/-0.20	1.05 +/-0.30	1.5+/-0.20	1.5 +/-0.20	< 1.80
B0	1.20 +/-0.20	1.80 +/-0.30	2.30 +/-0.20	2.30 +/-0.20	< 2.70
T	≤0.80	≤1.20	≤1.15	≤1.20	0.23 +/-0.1
K0	-	-	-	-	< 2.50
W	8.00 +/-0.30	8.00 +/-0.30	8.00 +/-0.30	8.00 +/-0.30	8.00 +/-0.30
P0	4.00 +/-0.10	4.00 +/-0.10	4.00 +/-0.10	4.00 +/-0.10	4.00 +/-0.10
10xP0	40.0 +/-0.10	40.0 +/-0.20	40.0 +/-0.20	40.0 +/-0.20	40.0 +/-0.20
P1	2.00 +/-0.05	4.00 +/-0.10	4.00 +/-0.10	4.00 +/-0.10	4.00 +/-0.10
P2	2.00 +/-0.05	2.00 +/-0.05	2.00 +/-0.05	2.00 +/-0.05	2.00 +/-0.05
D0	1.50 +0.1/-0	1.50 +0.1/-0	1.50 +0.1/-0	1.50 +0.1/-0	1.50 +0.1/-0
D1	-	-	-	-	1.00 +/-0.10
E	1.75 +/-0.10	1.75 +/-0.10	1.75 +/-0.10	1.75 +/-0.10	1.75 +/-0.10
F	3.50 +/-0.05	3.50 +/-0.05	3.50 +/-0.05	3.50 +/-0.05	3.50 +/-0.05

MULTILAYER CERAMIC CHIP CAPACITORS SH SERIES
TAPE DIMENSION (Unit: mm)

Size	1206			1210	
Thickness	B, T	C, J, D	G, P	C, D, G, K	M
A0	1.90 +/-0.50	< 2.00	< 2.30	< 3.05	< 3.20
B0	3.50 +/-0.50	< 3.70	< 4.00	< 3.80	< 4.00
T	≤1.20	0.23 +/-0.1	0.23 +/-0.1	0.23 +/-0.1	0.23 +/-0.1
K0	-	< 2.50	< 2.50	< 2.50	< 3.20
W	8.00 +/-0.30	8.00 +/-0.30	8.00 +/-0.30	8.00 +/-0.30	8.00 +/-0.30
P0	4.00 +/-0.10	4.00 +/-0.10	4.00 +/-0.10	4.00 +/-0.10	4.00 +/-0.10
10xP0	40.0 +/-0.20	40.0 +/-0.20	40.0 +/-0.20	40.0 +/-0.20	40.0 +/-0.20
P1	4.00 +/-0.10	4.00 +/-0.10	4.00 +/-0.10	4.00 +/-0.10	4.00 +/-0.10
P2	2.00 +/-0.05	2.00 +/-0.05	2.00 +/-0.05	2.00 +/-0.05	2.00 +/-0.05
D0	1.50 +0.1/-0	1.50 +0.1/-0	1.50 +0.1/-0	1.50 +0.1/-0	1.50 +0.1/-0
D1	-	1.00 +/-0.10	1.00 +/-0.10	1.00 +/-0.10	1.00 +/-0.10
E	1.75 +/-0.10	1.75 +/-0.10	1.75 +/-0.10	1.75 +/-0.10	1.75 +/-0.10
F	3.50 +/-0.05	3.50 +/-0.05	3.50 +/-0.05	3.50 +/-0.05	3.50 +/-0.05

Size	1808	1812		1825	
Thickness	D, F, G, K	D, F, G, K	M, U	K	M, U
A0	< 2.50	< 3.90	< 3.90	< 6.80	< 6.80
B0	< 5.30	< 5.30	< 5.30	< 5.30	< 5.30
T	0.25 +/-0.1	0.25 +/-0.1	0.25 +/-0.1	0.30 +/-0.1	0.30 +/-0.1
K0	< 2.50	< 2.50	< 3.50	< 2.50	< 3.50
W	12.00 +/-0.30	12.00 +/-0.30	12.00 +/-0.30	12.00 +/-0.30	12.00 +/-0.30
P0	4.00 +/-0.10	4.00 +/-0.10	4.00 +/-0.10	4.00 +/-0.10	4.00 +/-0.10
10xP0	40.0 +/-0.20	40.0 +/-0.20	40.0 +/-0.20	40.0 +/-0.20	40.0 +/-0.20
P1	4.00 +/-0.10	8.00 +/-0.10	8.00 +/-0.10	8.00 +/-0.10	8.00 +/-0.10
P2	2.00 +/-0.10	2.00 +/-0.10	2.00 +/-0.10	2.00 +/-0.10	2.00 +/-0.10
D0	1.50 +0.1/-0	1.50 +0.1/-0	1.50 +0.1/-0	1.50 +0.1/-0	1.50 +0.1/-0
D1	1.50 +/-0.10	1.50 +/-0.10	1.50 +/-0.10	1.50 +/-0.10	1.50 +/-0.10
E	1.75 +/-0.10	1.75 +/-0.10	1.75 +/-0.10	1.75 +/-0.10	1.75 +/-0.10
F	5.50 +/-0.10	5.50 +/-0.10	5.50 +/-0.10	5.50 +/-0.10	5.50 +/-0.10

MULTILAYER CERAMIC CHIP CAPACITORS SH SERIES

TAPE DIMENSION (Unit: mm)

Size	2220		2225	
	K	M, U	K	M, U
Thickness				
A0	< 5.80	< 5.80	< 6.80	< 6.80
B0	< 6.50	< 6.50	< 6.50	< 6.50
T	0.30 +/-0.1	0.30 +/-0.1	0.30 +/-0.1	0.30 +/-0.1
K0	< 2.50	< 3.50	< 2.50	< 3.50
W	12.00 +/-0.30	12.00 +/-0.30	12.00 +/-0.30	12.00 +/-0.30
P0	4.00 +/-0.10	4.00 +/-0.10	4.00 +/-0.10	4.00 +/-0.10
10xP0	40.0 +/-0.20	40.0 +/-0.20	40.0 +/-0.20	40.0 +/-0.20
P1	8.00 +/-0.10	8.00 +/-0.10	8.00 +/-0.10	8.00 +/-0.10
P2	2.00 +/-0.10	2.00 +/-0.10	2.00 +/-0.10	2.00 +/-0.10
D0	1.50 +0.1/-0	1.50 +0.1/-0	1.50 +0.1/-0	1.50 +0.1/-0
D1	1.50 +/-0.10	1.50 +/-0.10	1.50 +/-0.10	1.50 +/-0.10
E	1.75 +/-0.10	1.75 +/-0.10	1.75 +/-0.10	1.75 +/-0.10
F	5.50 +/-0.10	5.50 +/-0.10	5.50 +/-0.10	5.50 +/-0.10

MULTILAYER CERAMIC CHIP CAPACITORS SH SERIES

STORAGE AND HANDLING CONDITIONS

1. To store products at 5 to 40° C ambient temperature and 20 to 70% related humidity conditions; MSL Level 1.
2. The product is recommended to be used within one year after shipment. Check solderability in case of shelf life extension is needed.

CAUTIONS

1. The corrosive gas reacts on the terminal electrodes of capacitors, and results in the poor solder ability. Do not store the capacitors in the ambience of corrosive gas (e.g., hydrogen sulfide, sulfur dioxide, chlorine, ammonia gas etc.)
2. In corrosive atmosphere, solder ability might be degraded, and silver migration might occur to cause low reliability.
3. Due to the dewing by rapid humidity change, or the photochemical change of the terminal electrode by direct sun light, the solder ability and electrical performance may deteriorate. Do not store capacitors under direct sunlight or dewing condition. To store products on the shelf and avoid exposure to moisture.

CAUTION FOR SOFT TERMINATION PRODUCTS

Since the middle layer of the terminal electrode contains Ag (silver), when chip capacitors on printed circuit board (PCB), it should be protected by moisture proof-sealing to prevent electromigration of Ag under high temperature, high humidity and failure due to corrosive gas.

MULTILAYER CERAMIC CHIP CAPACITORS SH SERIES

ROHS COMPLIANCE

- The levels of RoHS restricted materials in this product are below the maximum concentration values (also referred to as the threshold limits) permitted for such substances, or are used in an exempted application, in accordance with EU RoHS Directive (EU) 2015/863 EC (RoHS3). RoHS Test Report for this product can be obtained from Download Center at www.nextgencomponent.com.

REACH COMPLIANCE

- REACH substances of high concern (SVHCs) information is available for this product. Since the European Chemical Agency (ECHA) has published notice of their intent to frequently revise the SVHC listing for the foreseeable future, REACH Test Report for this product can be obtained from Download Center at www.nextgencomponent.com.

DISCLAIMER AND NCNR

- 1) All Product parametric performance is indicated in the Electrical Characteristics for the listed herein test conditions, unless otherwise noted. Product performance may not be indicated by the Electrical Characteristics if operated under different conditions.
- 2) NextGen Component, Inc (*NextGen*) reserves the right to make changes to this document and its products and specifications at any time without notice. Customers should obtain and confirm the latest product information and specifications before final design, purchase or use.
- 3) *NextGen* makes no warranty, representation or guarantee regarding the suitability of its products for any particular purpose, not does *NextGen* assume any liability for application assistance or customer product design.
- 4) *NextGen* does not warrant or accept any liability with products which are purchased or used for any unintended or unauthorized application. No license is granted by implication or otherwise under any intellectual property rights of NextGen.
- 5) *NextGen* products are not authorized for use as critical components in life support devices or systems without express written approval by *NextGen*.
- 6) *NextGen* requires that customers first obtain an RMA (Returned Merchandise Authorization) number prior to returning any products. Returns must be made within 30 days of the date of invoice, be in the original packaging, unused and like-new condition. At the time of quoting or purchasing, a product may say that it is Non-Cancelable/ Non-Returnable (NCNR). These products are not returnable and not refundable.