

Specifications

Drawing No.	UKY1C-H1-23607-00[37] 1/12
Issued Date.	Jun.27,2023

TO: Digi-Key

Note: Part numbers may be revised in the event of any specifications change.

Product Type	Quartz Crystal
Series	CX2016SA
Frequency	Refer to Doc No. UKY1C-H1-23607-00[37] Page 3/12
Customer Part Number	-
Customer Specification Number	-
KYOCERA Part Number	Refer to Doc No. UKY1C-H1-23607-00[37] Page 3/12
Remarks	Pb-Free, RoHS Compliant, MSL 1 AEC-Q200 Compliant

Customer Approval

Approval Signature	Approved Date	
	Department	
	Person in charge	

Seller

KYOCERA Corporation

Corporate Electronic Components Group
Electronic Components Sales Division
6 Takeda Tobadono-cho, Fushimi-ku, Kyoto
612-8501 Japan
TEL. No. 075-604-3500
FAX. No. 075-604-3501

Manufacturer

Corporate Electronic Components Group
Electronic Devices Division

Design Department	Quality Assurance	Approved by	Checked by	Checked by	Issued by
KYOCERA Corporation Crystal Components Application Engineering Section1 Electronic Devices Division Corporate Electronic Components Group	A. Ito	W. Muraoka	F. Horie	T. Saito	Y. Kikuchi 

KYOCERA Corporation

Revision History

Rev.No.	Description of revision	Date	Approved by	Checked by	Issued by
00	First Edition	Jun.27,2023	W. Muraoka	F. Horie	Y. Kikuchi

【Part Number list】

Nominal Frequency (MHz) (*1)	KYOCERA Part Number	ESR (Ω) (*2)	Nominal Frequency Code (*3)
20.000	CX2016SA20000D0KSRCC	150	20000
30.000	CX2016SA30000D0KSRCC	60	30000
40.000	CX2016SA40000D0KSRCC	50	40000
50.000	CX2016SA50000D0KSRCC	50	50000

1. APPLICATION

This specification sheet is applied to quartz crystal

2. KYOCERA PART NUMBER

Refer to Doc No. UKY1C-H1-23607-00[37] Page 3/12

3. RATINGS

Items	SYMB.	Rating	Unit	Remarks
Operating Temperature Range	Topr	-40 to +125	°C	
Storage Temperature Range	Tstg	-40 to +125	°C	

4. CHARACTERISTICS

ELECTRICAL CHARACTERISTICS

Items	Electrical Specification					Test Condition	Remarks
	SYMB.	Min	Typ.	Max	Unit		
Mode of Vibration		Fundamental					
Nominal Frequency	F0		(*1)		MHz		
Nominal Temperature	T _{NOM}		+25		°C		
Load Capacitance	CL	8.0			pF		
Frequency Tolerance	df/F	-30.0		+30.0	PPM	+25±3°C	by Measurement Conditions
Frequency Temperature Characteristics	df/F	-40.0		+40.0		-40 to +125°C	Based on an oscillation frequency at +25 °C
Frequency Aging Rate		-2.0		+2.0		1 st year	+25±3°C
Equivalent Series Resistance	ESR			(*2)	Ω		by Measurement Conditions
Drive Level	Pd	0.01		200	μW		
Insulation Resistance	IR	500			MΩ	100V(DC)	

*1 *2 Refer to Doc No. UKY1C-H1-23607-00[37] Page 3/12

5. Measurement Condition

5.1 Frequency measurement

Measuring instrument : IEC PI-Network Test Fixture

Load Capacitance : 8.0pF

Drive Level : 10 μ W

5.2 Equivalent series resistance (ESR) measurement

Measuring instrument : IEC PI-Network Test Fixture

Load Capacitance : Series

Drive Level : 10 μ W

6. APPEARANCES, DIMENSIONS
OUTLINE DIMENSION (not to scale)

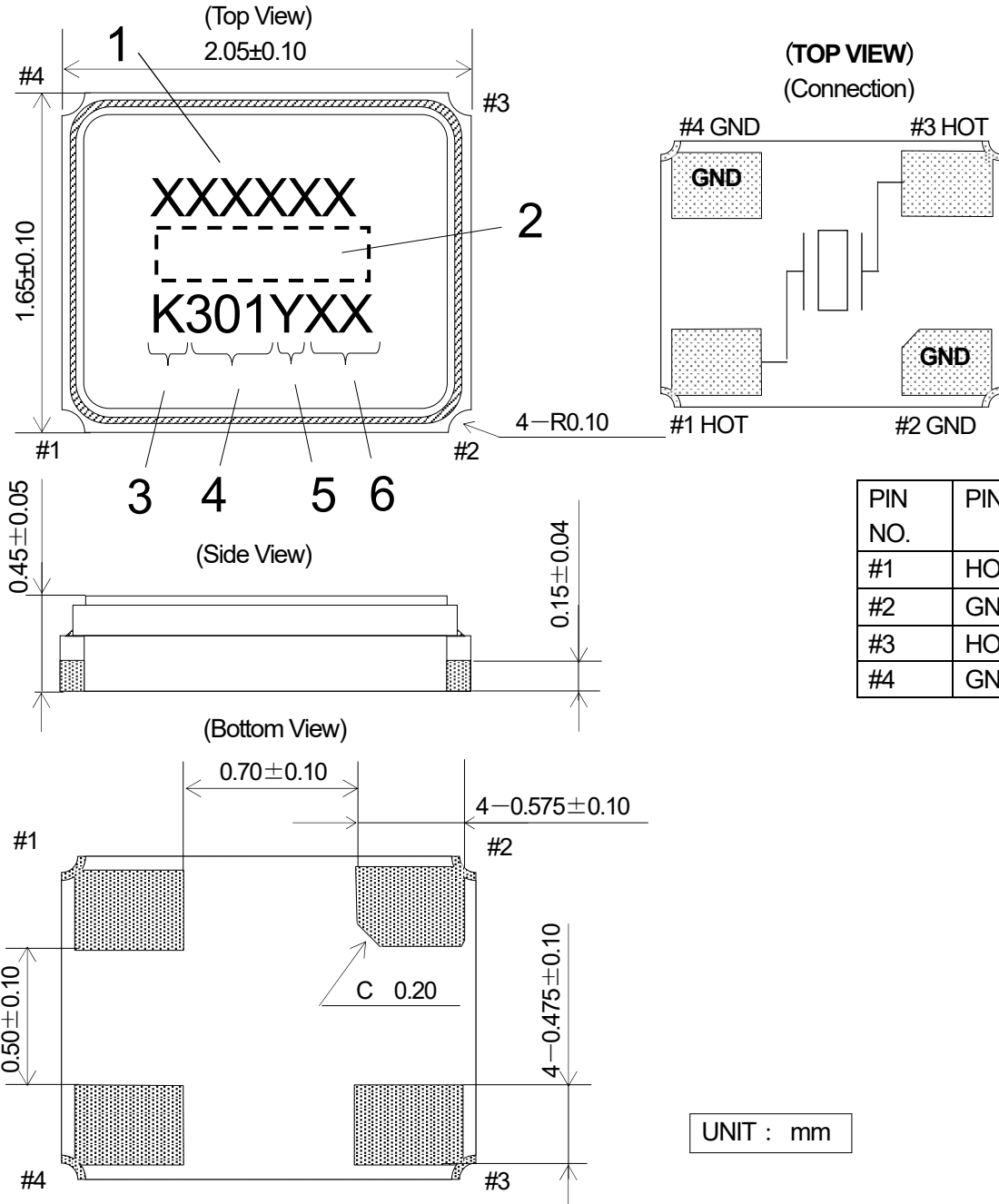

PIN NO.	PIN Layout
#1	HOT
#2	GND
#3	HOT
#4	GND

UNIT : mm

MARKING

- 1. Serial Code 6Digits
- 2. Nominal Frequency First 5digit of the frequency is indicated.
 *3 Refer to Doc No. UKY1C-H1-23607-00[37] Page 3/12
- 3. Identification [K] is to indicate 1Pin direction.
- 4. Date Code Last 1 Digit of YEAR and WEEK
 (Ex) 2023,Jan,01 → 301
- 5. Manufacturing Location Y··Japan (Yamagata)
 Z··Japan (Shiga Yohkaichi)
 V··Vietnam
- 6. Internal code

※The font of marking is for reference only.

KYOCERA Corporation

7. RECOMMENDED LAND PATTERN (not to scale)

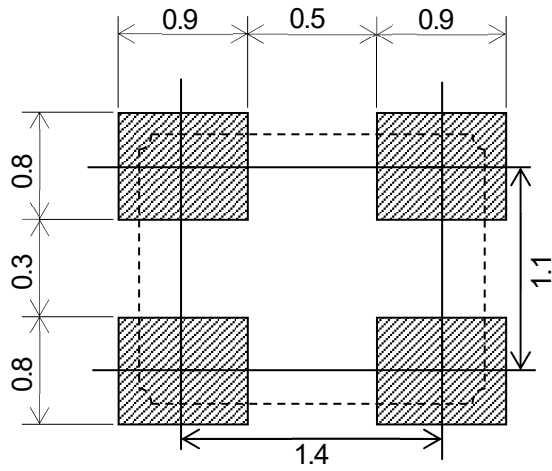

UNIT : mm

8. TAPING & REEL

8-1. Dimensions

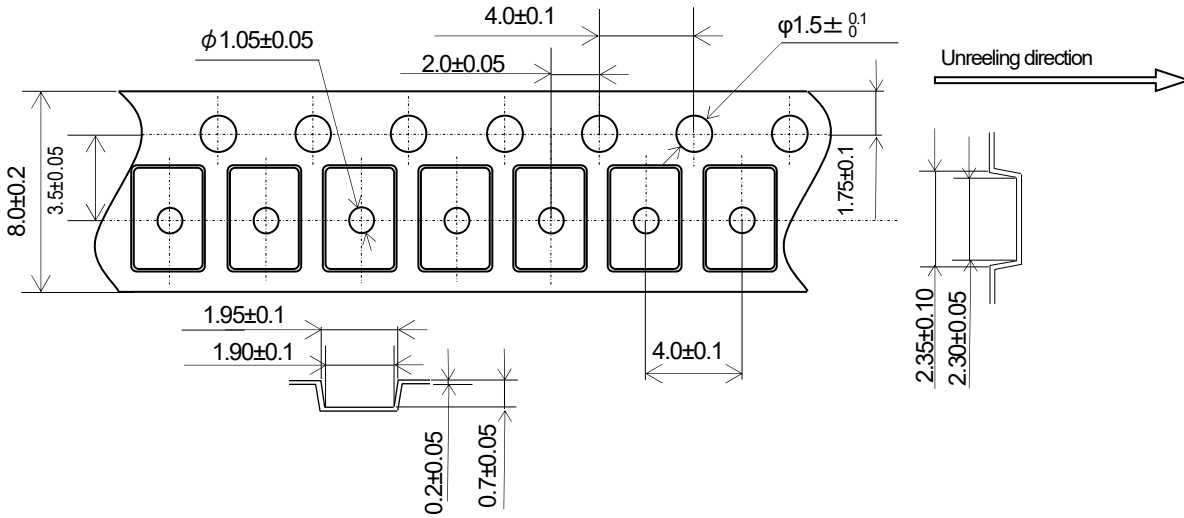

8-2. Leader and trailer tape

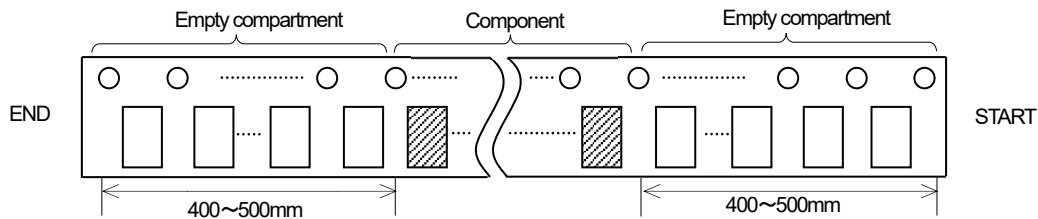

8-3. Direction (The direction shall be seen from the top cover tape side)

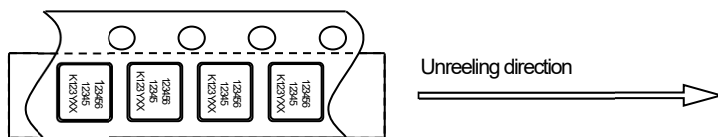

8-4. Specification

1. Material of the carrier tape is either polystyrene or A—PET (ESD).
2. Material of the cover tape is PET/PE (ESD).
3. The seal tape shall not cover the sprocket holes and not protrude from the carrier tape.
4. Tensile strength of carrier tape: 10N or more.
5. The R of the corner of each cavity is $0.2R_{MAX}$.
6. The alignment between centers of the cavity and sprocket hole shall be 0.05mm or less.
7. The orientation shall be checked from the top cover tape side as shown in 8-3.
8. Peeling force of cover tape: 0.1 to 1.0N.
9. The component will fall out naturally when cover tape is removed and set upside down.

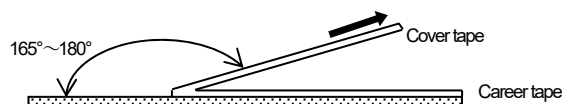

8-5.Reel Specification

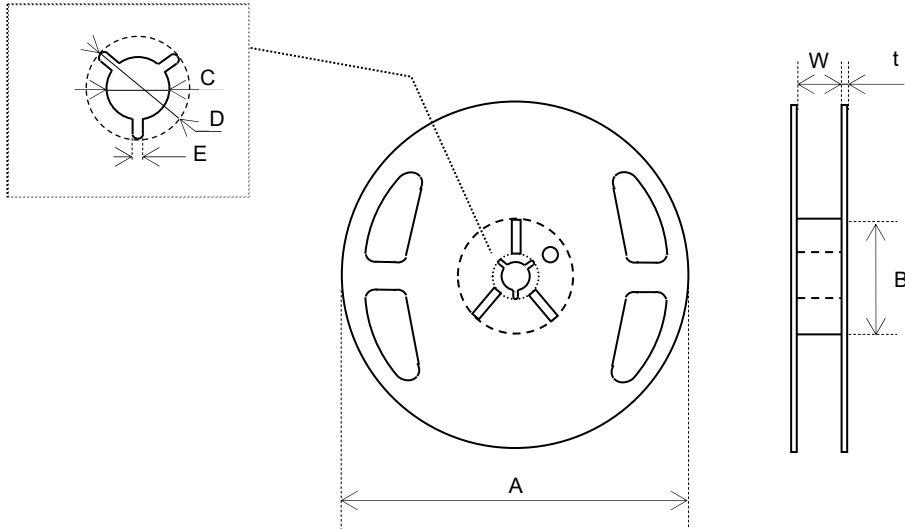

φ180 Reel (3,000pcs Max)

Symbol	A	B	C	D
Dimension	φ180 +0/-3	φ60 +1/-0	φ13±0.2	φ21±0.8
Symbol	E	W	t	
Dimension	2.0±0.5	9±1	2.0±0.5	

(Unit : mm)

φ330 Reel (15,000pcs Max)

Symbol	A	B	C	D
Dimension	φ330±2.0	φ100±1.0	φ13±0.2	φ21±0.8
Symbol	E	W	t	
Dimension	2.0±0.5	9.5±0.5	2.2±0.1	

(Unit : mm)

9. ENVIRONMENTAL AND MECHANICAL CHARACTERISTICS :

(Reference: AEC-Q200 Rev. D. The solder used by examination is hereafter set to Sn-3Ag-0.5Cu.)

After following test, frequency shall not change more than $\pm 10 \times 10^{-6}$ and CI, $\pm 20\%$ or 5Ω .

No	Stress	Reference	Additional Requirements
9.1	High Temperature Exposure (Storage)	MIL-STD-202 Method 108	1000 hrs. at rated operating temperature (e.g. 85°C part can be stored for 1000 hours at 85°C. Same applies for 125°C). Unpowered. Measurement at 24±4 hours after test conclusion.
9.2	Temperature Cycling	JESD22 Method JA-104	1000 cycles (-40°C to 125°C) Note: If 85°C parts the 1000 cycles will be at that temperature rating. Measurement at 24±4 hours after test conclusion. 30min maximum dwell time at each temperature extreme. 1 min. maximum transition time.
9.3	Biased Humidity	MIL-STD-202 Method 103	1000 hours 85°C/85%RH. Rated VDD applied with 1MΩ and inverter in parallel, 2X crystal CL capacitors between each crystal leg and GND. Measurement at 24±4 hours after test conclusion.
9.4	Operational Life	MIL-STD-202 Method 108	Note: 1000 hours @ 125°C. If 85°C part will be tested at that temperature. Rated VDD applied with 1 MΩ and inverter in parallel, 2X crystal CL capacitors between each crystal leg and GND. Measurement at 24±4 hours after test conclusion.
9.5	Resistance to Solvents	MIL-STD-202 Method 215	Note: Also aqueous wash chemical - OKEM clean or equivalent. Do not use banned solvents.
9.6	Mechanical Shock	MIL-STD-202 Method 213	Figure 1 of Method 213. Condition C
9.7	Vibration	MIL-STD-202 Method 204	5g's for 20 minutes 12 cycles each of 3 orientations. Note: Use 8"X5" PCB .031" thick with 7 secure points on one 8" side and 2 secure points on corners of opposite sides. Parts mounted within 2" from any secure point. Test from 10-2000 Hz.
9.8	Resistance to Soldering Heat	MIL-STD-202 Method 210	Condition B. No pre-heat of samples. Solder temp: $260 \pm 5^\circ\text{C}$, Soaking time: $10 \pm 1\text{sec}$, Number of tests: 1 Note: The electrodes are immersed in molten solder to a level that covers the electrodes of the component.
9.9	Solder ability	J-STD-002	Evaluate the solderability of external electrodes of components. Conditions (SMD): Method D category 3, Solder temp: $260 \pm 5^\circ\text{C}$, Soaking time: 30+5/-0sec.
9.10	Board Flex	AEC Q200-005	Maintain a bend depth of 2 mm for 60 seconds. Note: Use FR4 substrate with external dimensions of 100 x 40 mm and thickness of 1.6 ± 0.2 mm.
9.11	Terminal Strength (SMD)	AEC Q200-006	A pushing force of 17.7 N perpendicular to the side of the specimen on the test substrate is applied for 60 seconds

10. Soldering condition

- 1.) Material of solder
 Kind ... lead free solder paste
 Melting point ... $+220 \pm 5^{\circ}\text{C}$

- 2.) Reflow temp.profile

	Temp [$^{\circ}\text{C}$]	Time[sec]
Preheating	+150 to +180	150 (typ.)
Peak	$+260 \pm 5$	10 (max.)
Total	—	300 (max.)

Frequency shift : $\pm 2\text{ppm}$

- 3.) Hand Soldering $+350^{\circ}\text{C}$ 3 sec MAX
- 4.) Reflow Times 2 times

Reflow temp.profile

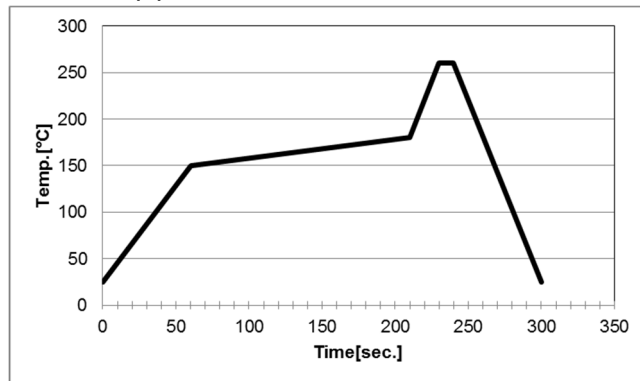

11. Cautions for use

- (1) Soldering upon mounting
 There is a possibility to influence product characteristics when Solder paste or conductive glue comes in contact with product lid or surface.
- (2) When using mounting machine
 Please minimize the shock when using mounting machine to avoid any excess stress to the product.
- (3) Conformity of a circuit
 We strongly recommend to make sure that Negative resistance (Gain) of IC is designed to be 10 times the ESR (Equivalent Series Resistance) of crystal unit.

12. Storage conditions

Please store product in below conditions, and use within 6 months.
 Temperature $+18$ to $+30^{\circ}\text{C}$, and Humidity of 20 to 70 % in the packaging condition.

13. Manufacturing location

Kyocera Corporation Yamagata Higashine Plant / Japan(Yamagata)
 Kyocera Corporation Shiga Yohkaichi Plant / Japan(Shiga)
 Kyocera Vietnam Co., LTD. / Vietnam

14. Quality Assurance

To be guaranteed by Kyocera Corporation Yamagata Higashine Plant Quality Assurance Division

15. Quality guarantee

In case when Kyocera Corporation rooted failure occurred within 1year after its delivery, substitute product will be arranged based on discussion. Quality guarantee of product after 1year of its delivery is waived.

16. Others

In case of any questions or opinions regarding the Specification, please have it in written manner within 45 days after issued date.