

## N-channel 950 V, 1 $\Omega$ typ., 9 A MDmesh™ K5 Power MOSFET in an I<sup>2</sup>PAK package

Datasheet - production data

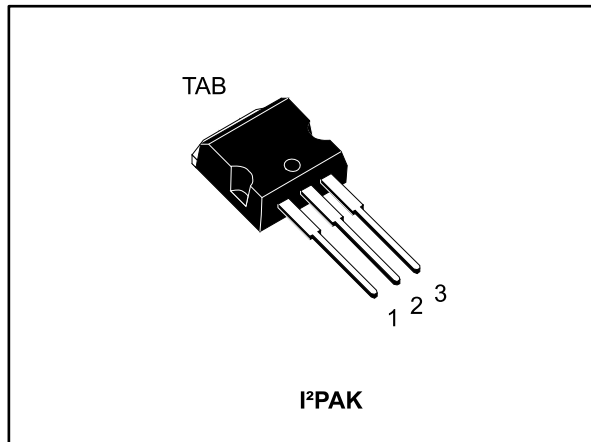

Figure 1: Internal schematic diagram

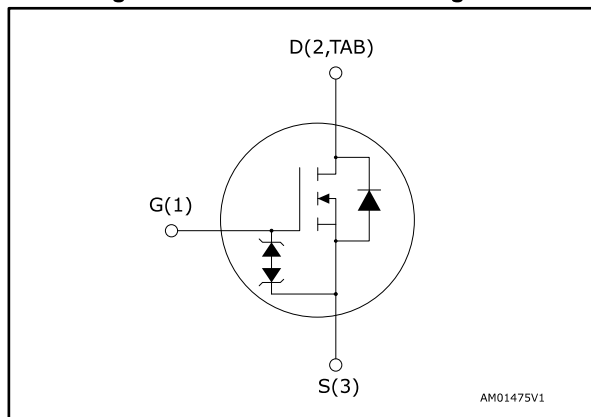

Table 1: Device summary

Order code	Marking	Package	Packing
STI6N95K5	6N95K5	I <sup>2</sup> PAK	Tube

### Features

Order code	V <sub>DS</sub>	R <sub>DS(on)</sub> max.	I <sub>D</sub>	P <sub>TOT</sub>
STI6N95K5	950 V	1.25 $\Omega$	9 A	90 W

- Industry's lowest R<sub>DS(on)</sub> x area
- Industry's best FoM (figure of merit)
- Ultra-low gate charge
- 100% avalanche tested
- Zener-protected

### Applications

- Switching applications

### Description

This very high voltage N-channel Power MOSFET is designed using MDmesh™ K5 technology based on an innovative proprietary vertical structure. The result is a dramatic reduction in on-resistance and ultra-low gate charge for applications requiring superior power density and high efficiency.

---

## Contents

<b>1</b>	<b>Electrical ratings .....</b>	<b>3</b>
<b>2</b>	<b>Electrical characteristics .....</b>	<b>4</b>
	2.1 Electrical characteristics (curves).....	6
<b>3</b>	<b>Test circuits .....</b>	<b>8</b>
<b>4</b>	<b>Package information .....</b>	<b>9</b>
	4.1 I <sup>2</sup> PAK package information .....	9
<b>5</b>	<b>Revision history .....</b>	<b>11</b>

# 1 Electrical ratings

**Table 2: Absolute maximum ratings**

Symbol	Parameter	Value	Unit
$V_{GS}$	Gate-source voltage	$\pm 30$	V
$I_D$	Drain current (continuous) at $T_C = 25\text{ }^\circ\text{C}$	9	A
$I_D$	Drain current (continuous) at $T_C = 100\text{ }^\circ\text{C}$	6	A
$I_{DM}^{(1)}$	Drain current (pulsed)	36	A
$P_{TOT}$	Total dissipation at $T_C = 25\text{ }^\circ\text{C}$	90	W
$dv/dt^{(2)}$	Peak diode recovery voltage slope	4.5	V/ns
$dv/dt^{(3)}$	MOSFET $dv/dt$ ruggedness	50	
$T_j$	Operating junction temperature range	- 55 to 150	$^\circ\text{C}$
$T_{stg}$	Storage temperature range		

**Notes:**

(1) Pulse width limited by safe operating area

(2)  $I_{SD} \leq 9\text{ A}$ ,  $di/dt \leq 100\text{ A}/\mu\text{s}$ ;  $V_{DS\text{ peak}} < V_{(BR)DSS}$

(3)  $V_{DS} \leq 760\text{ V}$

**Table 3: Thermal data**

Symbol	Parameter	Value	Unit
$R_{thj-case}$	Thermal resistance junction-case	1.39	$^\circ\text{C}/\text{W}$
$R_{thj-amb}$	Thermal resistance junction-ambient	62.5	$^\circ\text{C}/\text{W}$

**Table 4: Avalanche characteristics**

Symbol	Parameter	Value	Unit
$I_{AR}$	Avalanche current, repetitive or not repetitive (pulse width limited by $T_{jmax}$ )	3	A
$E_{AS}$	Single pulse avalanche energy (starting $T_j = 25\text{ }^\circ\text{C}$ , $I_D = I_{AR}$ , $V_{DD} = 50\text{ V}$ )	90	mJ

## 2 Electrical characteristics

$T_C = 25\text{ }^\circ\text{C}$  unless otherwise specified

**Table 5: On/off-state**

Symbol	Parameter	Test conditions	Min.	Typ.	Max.	Unit
$V_{(BR)DSS}$	Drain-source breakdown voltage	$V_{GS} = 0\text{ V}$ , $I_D = 1\text{ mA}$	950			V
$I_{DSS}$	Zero gate voltage drain current	$V_{GS} = 0\text{ V}$ , $V_{DS} = 950\text{ V}$			1	$\mu\text{A}$
		$V_{GS} = 0\text{ V}$ , $V_{DS} = 950\text{ V}$ $T_C = 125\text{ }^\circ\text{C}^{(1)}$			50	$\mu\text{A}$
$I_{GSS}$	Gate body leakage current	$V_{DS} = 0\text{ V}$ , $V_{GS} = \pm 20\text{ V}$			$\pm 10$	$\mu\text{A}$
$V_{GS(th)}$	Gate threshold voltage	$V_{DD} = V_{GS}$ , $I_D = 100\text{ }\mu\text{A}$	3	4	5	V
$R_{DS(on)}$	Static drain-source on-resistance	$V_{GS} = 10\text{ V}$ , $I_D = 3\text{ A}$		1	1.25	$\Omega$

**Notes:**

<sup>(1)</sup> Defined by design, not subject to production test.

**Table 6: Dynamic**

Symbol	Parameter	Test conditions	Min.	Typ.	Max.	Unit
$C_{iss}$	Input capacitance	$V_{DS} = 100\text{ V}$ , $f = 1\text{ MHz}$ , $V_{GS} = 0\text{ V}$	-	450	-	pF
$C_{oss}$	Output capacitance		-	30	-	pF
$C_{riss}$	Reverse transfer capacitance		-	1.6	-	pF
$C_{o(tr)}^{(1)}$	Equivalent capacitance time related	$V_{DS} = 0\text{ to }760\text{ V}$ , $V_{GS} = 0\text{ V}$	-	45	-	pF
$C_{o(er)}^{(2)}$	Equivalent capacitance energy related		-	19	-	pF
$R_g$	Intrinsic gate resistance	$f = 1\text{ MHz}$ , $I_D = 0\text{ A}$	-	7	-	$\Omega$
$Q_g$	Total gate charge	$V_{DD} = 760\text{ V}$ , $I_D = 6\text{ A}$ $V_{GS} = 0\text{ to }10\text{ V}$ (see <a href="#">Figure 15: "Test circuit for gate charge behavior"</a> )	-	13	-	nC
$Q_{gs}$	Gate-source charge		-	3	-	nC
$Q_{gd}$	Gate-drain charge		-	7	-	nC

**Notes:**

<sup>(1)</sup>  $C_{o(tr)}$  is a constant capacitance value that gives the same charging time as  $C_{oss}$  while  $V_{DS}$  is rising from 0 to 80%  $V_{DSS}$ .

<sup>(2)</sup>  $C_{o(er)}$  is a constant capacitance value that gives the same stored energy as  $C_{oss}$  while  $V_{DS}$  is rising from 0 to 80%  $V_{DSS}$ .

Table 7: Switching times

Symbol	Parameter	Test conditions	Min.	Typ.	Max.	Unit
$t_{d(on)}$	Turn-on delay time	$V_{DD} = 475 \text{ V}$ , $I_D = 3 \text{ A}$ , $R_G = 4.7 \text{ } \Omega$ $V_{GS} = 10 \text{ V}$ (see <a href="#">Figure 14: "Test circuit for resistive load switching times"</a> and <a href="#">Figure 19: "Switching time waveform"</a> )	-	12	-	ns
$t_r$	Rise time		-	12	-	ns
$t_{d(off)}$	Turn-off delay time		-	33	-	ns
$t_f$	Fall time		-	21	-	ns

Table 8: Source-drain diode

Symbol	Parameter	Test conditions	Min.	Typ.	Max.	Unit
$I_{SD}$	Source-drain current		-		9	A
$I_{SDM}^{(1)}$	Source-drain current (pulsed)		-		36	A
$V_{SD}^{(2)}$	Forward on voltage	$I_{SD} = 6 \text{ A}$ , $V_{GS} = 0 \text{ V}$	-		1.6	V
$t_{rr}$	Reverse recovery time	$I_{SD} = 6 \text{ A}$ , $di/dt = 100 \text{ A}/\mu\text{s}$ , $V_{DD} = 60 \text{ V}$ (see <a href="#">Figure 16: "Test circuit for inductive load switching and diode recovery times"</a> )	-	372		ns
$Q_{rr}$	Reverse recovery charge		-	4		$\mu\text{C}$
$I_{RRM}$	Reverse recovery current		-	22		A
$t_{rr}$	Reverse recovery time	$I_{SD} = 6 \text{ A}$ , $di/dt = 100 \text{ A}/\mu\text{s}$ , $V_{DD} = 60 \text{ V}$ , $T_j = 150 \text{ }^\circ\text{C}$ (see <a href="#">Figure 16: "Test circuit for inductive load switching and diode recovery times"</a> )	-	522		ns
$Q_{rr}$	Reverse recovery charge		-	5		$\mu\text{C}$
$I_{RRM}$	Reverse recovery current		-	20		A

**Notes:**

(1)Pulse width limited by safe operating area

(2)Pulsed: pulse duration = 300  $\mu\text{s}$ , duty cycle 1.5%

Table 9: Gate-source Zener diode

Symbol	Parameter	Test conditions	Min.	Typ.	Max.	Unit
$V_{(BR)GSO}$	Gate-source breakdown voltage	$I_{GS} = \pm 1 \text{ mA}$ , $I_D = 0 \text{ A}$	30	-	-	V

The built-in back-to-back Zener diodes are specifically designed to enhance the ESD performance of the device. The Zener voltage facilitates efficient and cost-effective device integrity protection, thus eliminating the need for additional external componentry.

## 2.1 Electrical characteristics (curves)

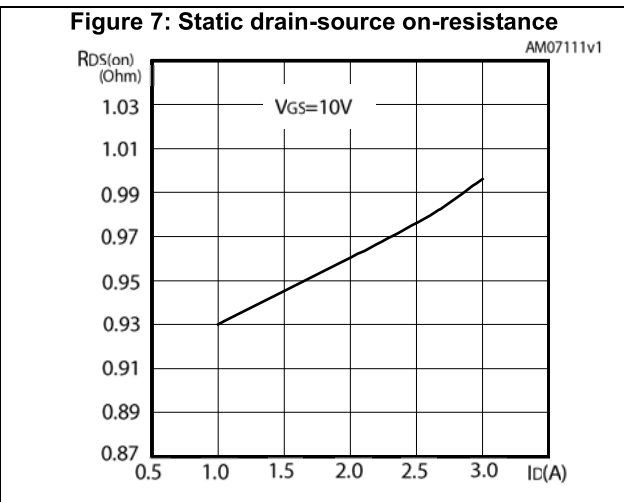
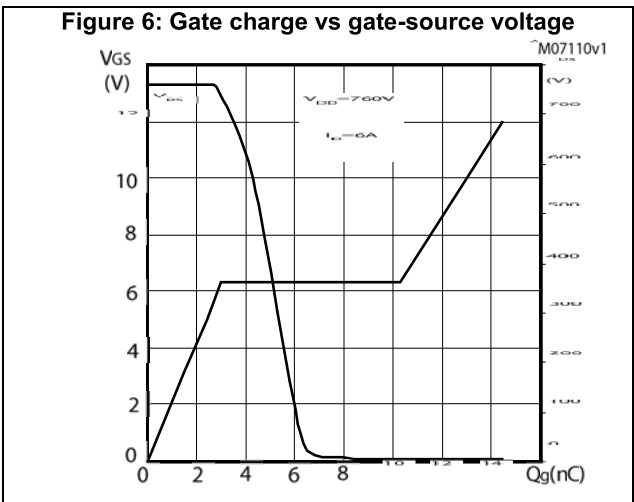
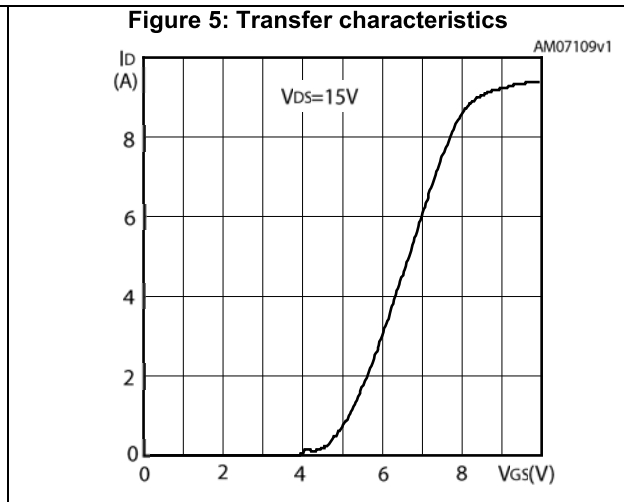
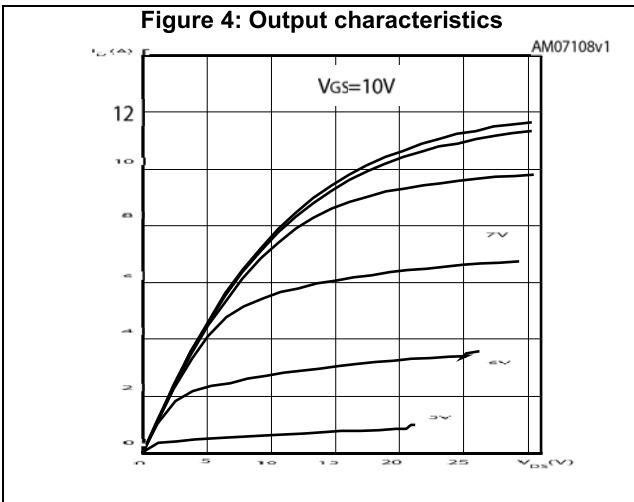
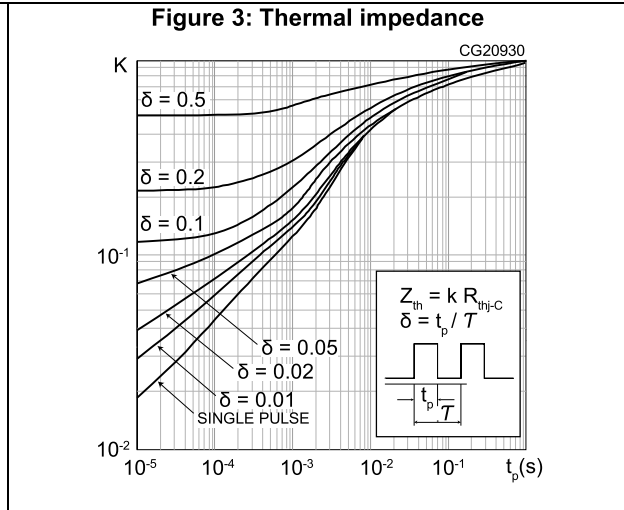
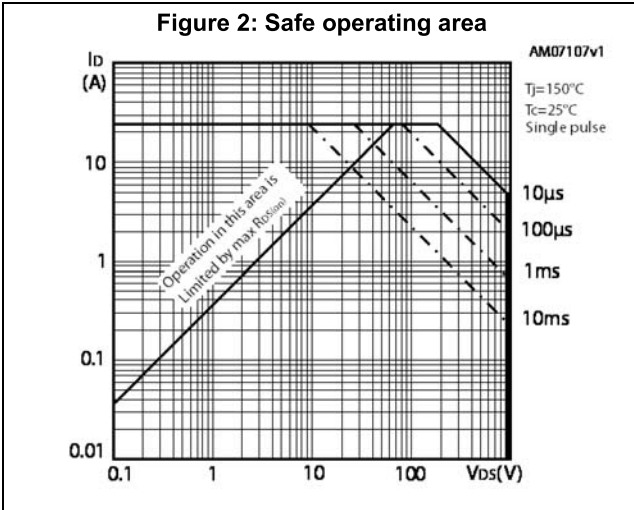

Figure 8: Capacitance variations

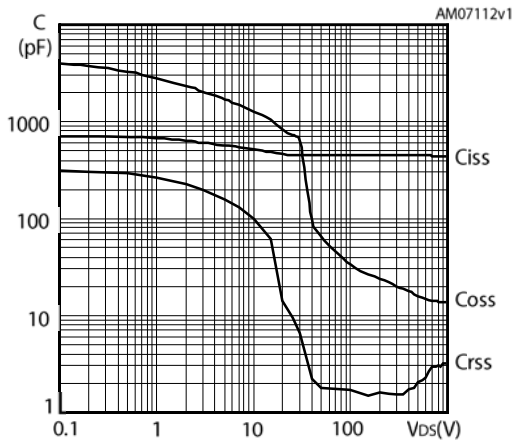

Figure 9: Normalized gate threshold voltage vs temperature

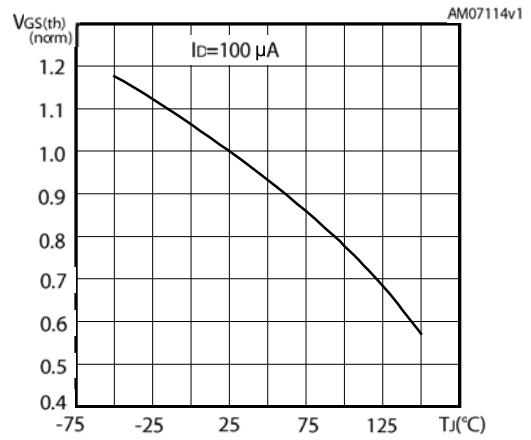

Figure 10: Normalized on-resistance vs temperature

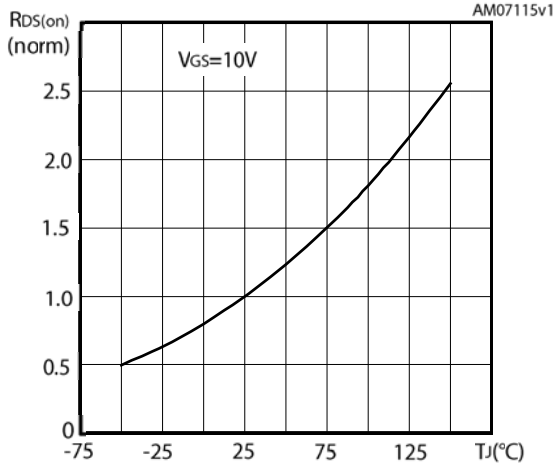

Figure 11: Normalized V(BR)DSS vs temperature

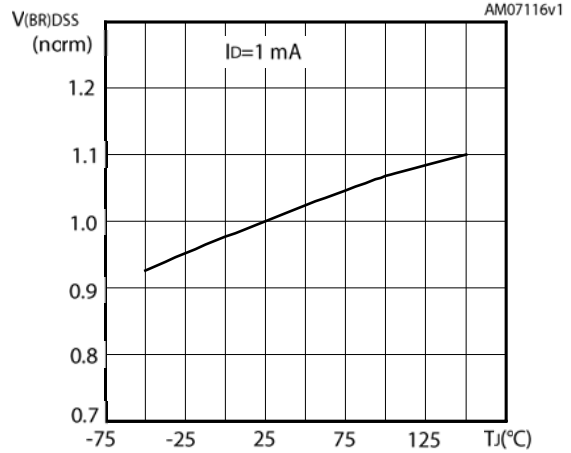

Figure 12: Maximum avalanche energy vs starting Tj

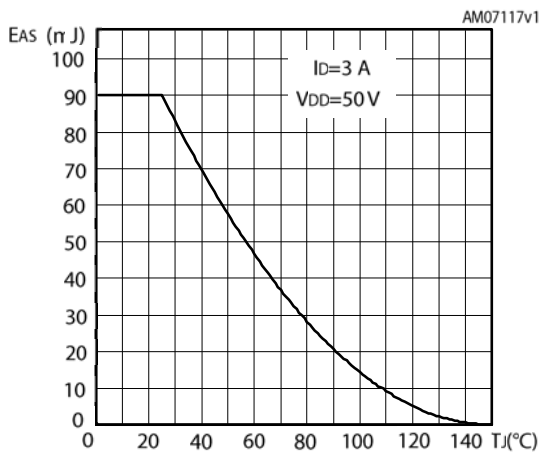
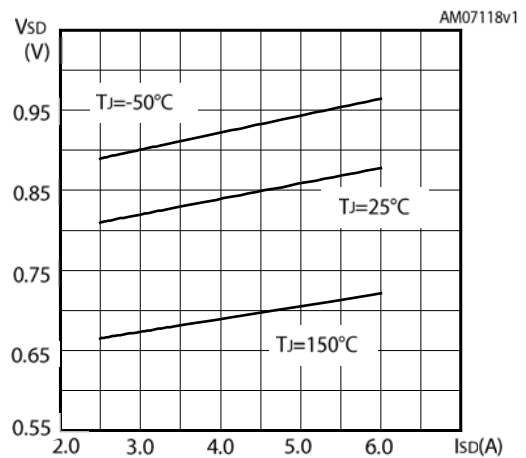
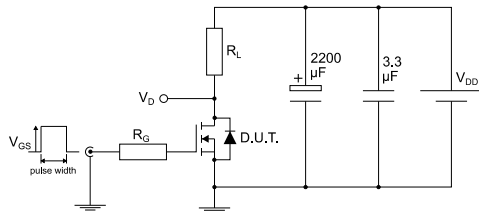

Figure 13: Source-drain diode forward characteristics



### 3 Test circuits

**Figure 14: Test circuit for resistive load switching times**



AM01468v1

**Figure 15: Test circuit for gate charge behavior**

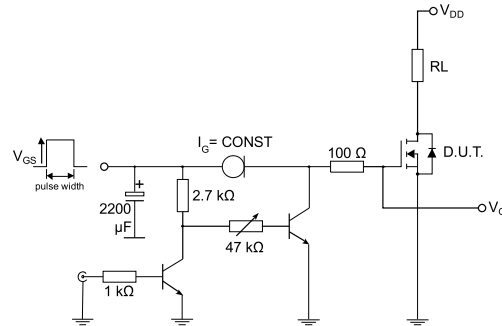

AM01469v10

**Figure 16: Test circuit for inductive load switching and diode recovery times**

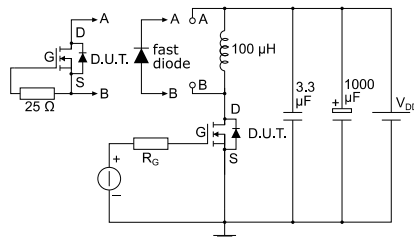

AM01470v1

**Figure 17: Unclamped inductive load test circuit**

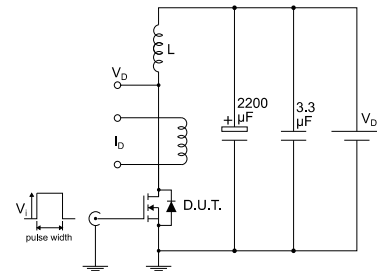

AM01471v1

**Figure 18: Unclamped inductive waveform**

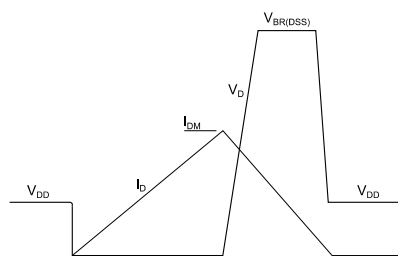

AM01472v1

**Figure 19: Switching time waveform**

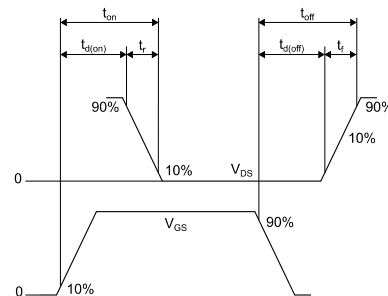

AM01473v1



## 4 Package information

In order to meet environmental requirements, ST offers these devices in different grades of ECOPACK® packages, depending on their level of environmental compliance. ECOPACK® specifications, grade definitions and product status are available at: [www.st.com](http://www.st.com). ECOPACK® is an ST trademark.

### 4.1 I<sup>2</sup>PAK package information

Figure 20: I<sup>2</sup>PAK package outline

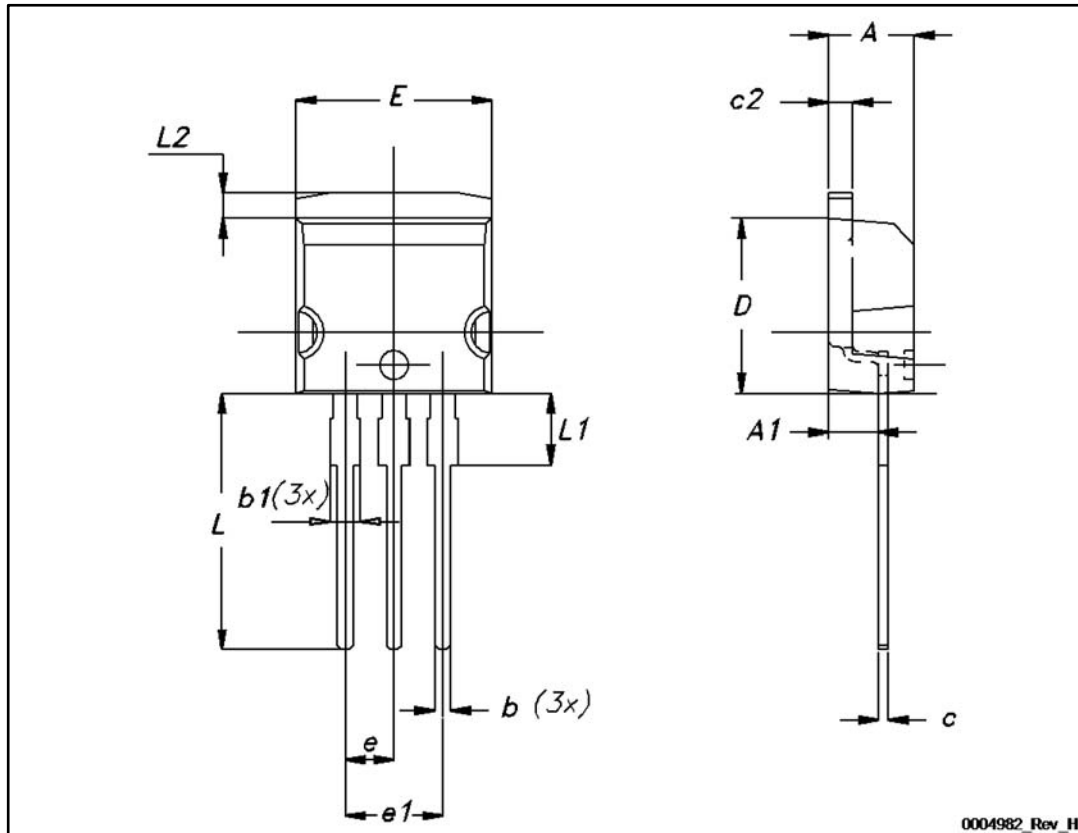

Table 10: I<sup>2</sup>PAK package mechanical data

Dim.	mm		
	Min.	Typ.	Max.
A	4.40	-	4.60
A1	2.40	-	2.72
b	0.61	-	0.88
b1	1.14	-	1.70
c	0.49	-	0.70
c2	1.23	-	1.32
D	8.95	-	9.35
e	2.40	-	2.70
e1	4.95	-	5.15
E	10	-	10.40
L	13	-	14
L1	3.50	-	3.93
L2	1.27	-	1.40

## 5 Revision history

Table 11: Document revision history

Date	Revision	Changes
03-May-2017	1	First release.

**IMPORTANT NOTICE – PLEASE READ CAREFULLY**

STMicroelectronics NV and its subsidiaries (“ST”) reserve the right to make changes, corrections, enhancements, modifications, and improvements to ST products and/or to this document at any time without notice. Purchasers should obtain the latest relevant information on ST products before placing orders. ST products are sold pursuant to ST’s terms and conditions of sale in place at the time of order acknowledgement.

Purchasers are solely responsible for the choice, selection, and use of ST products and ST assumes no liability for application assistance or the design of Purchasers’ products.

No license, express or implied, to any intellectual property right is granted by ST herein.

Resale of ST products with provisions different from the information set forth herein shall void any warranty granted by ST for such product.

ST and the ST logo are trademarks of ST. All other product or service names are the property of their respective owners.

Information in this document supersedes and replaces information previously supplied in any prior versions of this document.

© 2017 STMicroelectronics – All rights reserved