

### Features

- High Power Capability
- High Temperature Application
- Low Leakage
- Open Junction Technic
- Suffix "-Q1" for AEC-Q101

### Polarity

- F35UP-Q1- Cathode Toward to Case
- F35UN-Q1- Anode Toward to Case

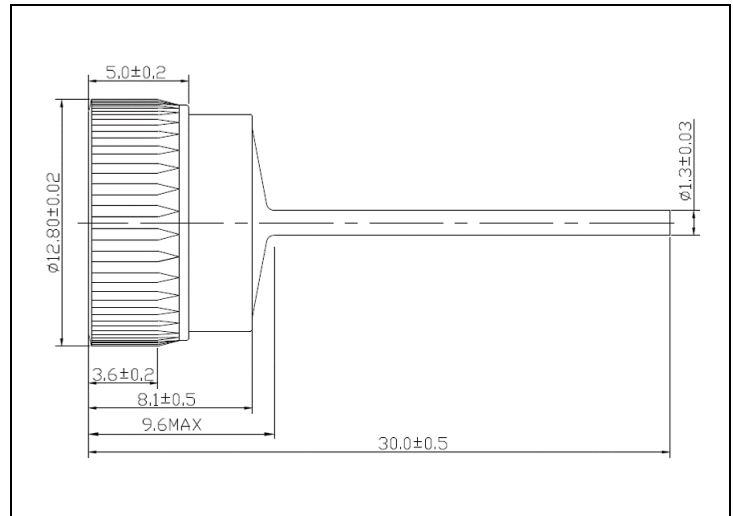

### Maximum Ratings (Ta=25°C)

CHARACTERISTIC	SYMBOL	RATING	UNIT
Average Forward Current	$I_{F(AV)}$	35	A
Non-repeative Forward Peak Surge Current (Half Sine Wave,50Hz,1 Cycle)	$I_{FSM}$	420	A
Maximum Repeative Peak Reverse Voltage	$V_{RRM}$	32	V
Junction Temperature	$T_j$	-40~215	°C
Thermal Resistance Junction to Case	$R_{\theta JC}$	0.7	°C/W

### Electrical Characteristics (Ta=25°C)

CHARACTERISTIC	SYMBOL	TEST CONDITION	VALUE	UNIT
Maximum Forward Voltage	$V_{FM}$	$I_{FM}=100A, PW=10mS$	1.12	V
Maximum Reverse Current	$I_{RRM1}$	$V_{RRM}=32V$	0.2	uA
Maximum Reverse Current Under High Temperature	$I_{RRM2}$	$T_a=150^{\circ}C, V_{RRM}=32V$	100	uA
Minimum Breakdown Voltage	$V_{BR}$	$I_B=10mA, T=10mS$	34~40	V

## Rating And Characteristic Curves

