

Core Fit Reference

0584		EI-96	EI-125
		Metric	American

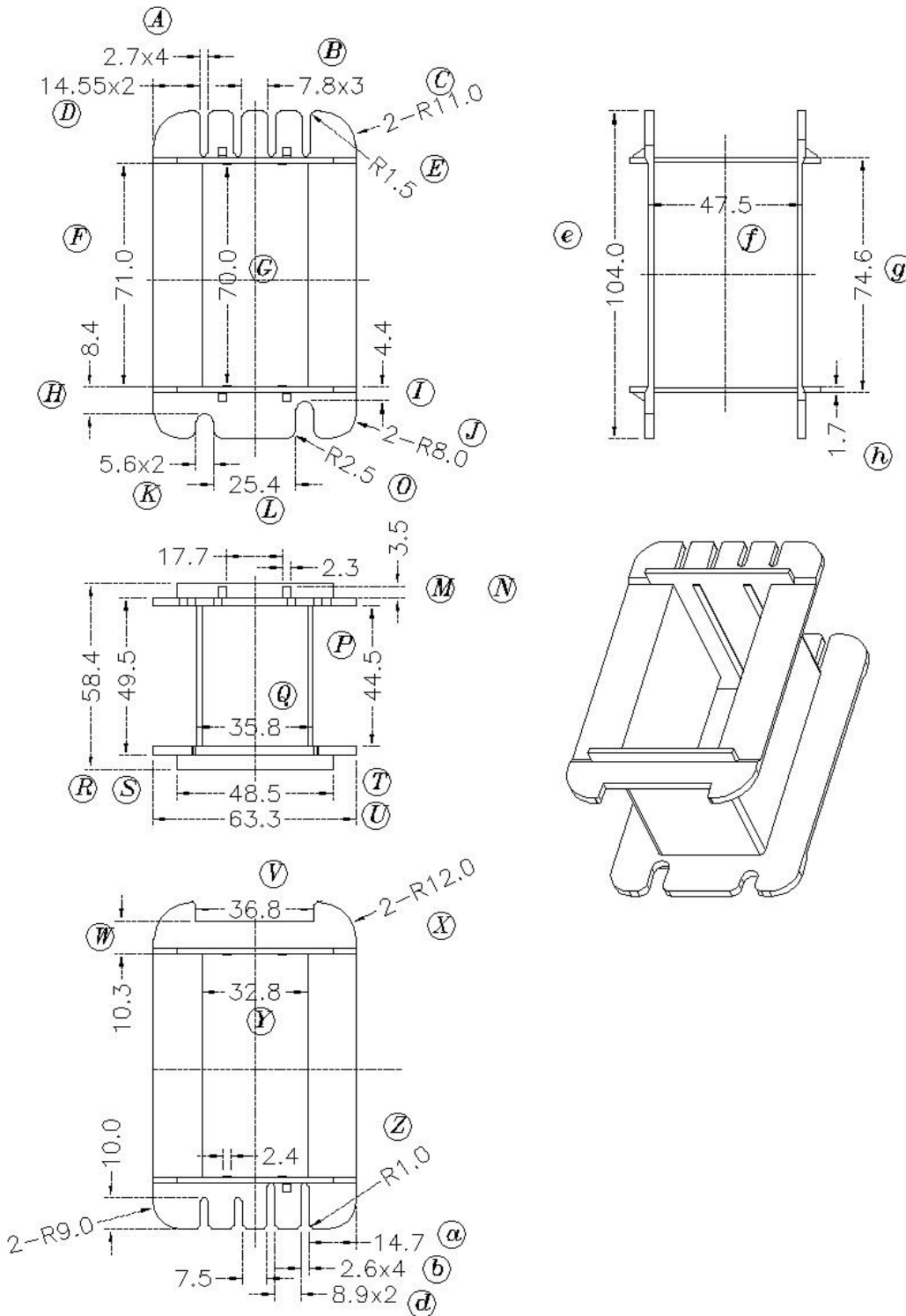
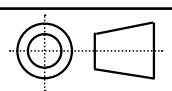

	Scale	Tolerance (mm)			Terminal Plating	Terminal Material	No of Terminals	
	None	0-4mm +/-0.1	4-16mm +/-0.2	16-60mm +/-0.3	100% Sn	CP Wire		

LODESTONE PACIFIC

CHINA FACTORY
www.lodestonepacific.com

Molding Material	UL File No.	Rating	Class
FR530	E41938	UL94-V0	N
Bobbin Part Number			Rev No
B-EIM96X70-1-PET			1