

Core Fit Reference

0773		EI-86	EI-112
		Metric	American

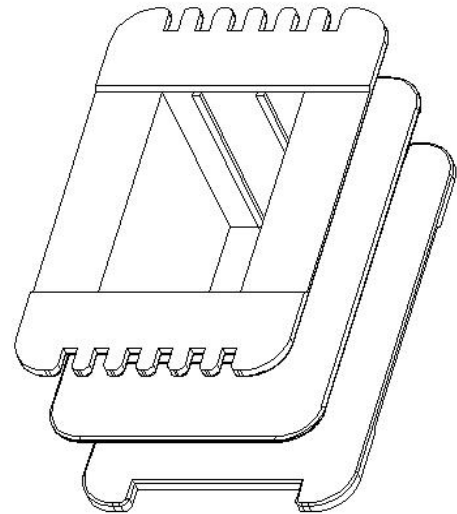

	Scale	Tolerance (mm)			Terminal Plating	Terminal Material	No of Terminals	
	None	0-4mm +/-0.1	4-16mm +/-0.2	16-60mm +/-0.3	100% Sn	CP Wire		

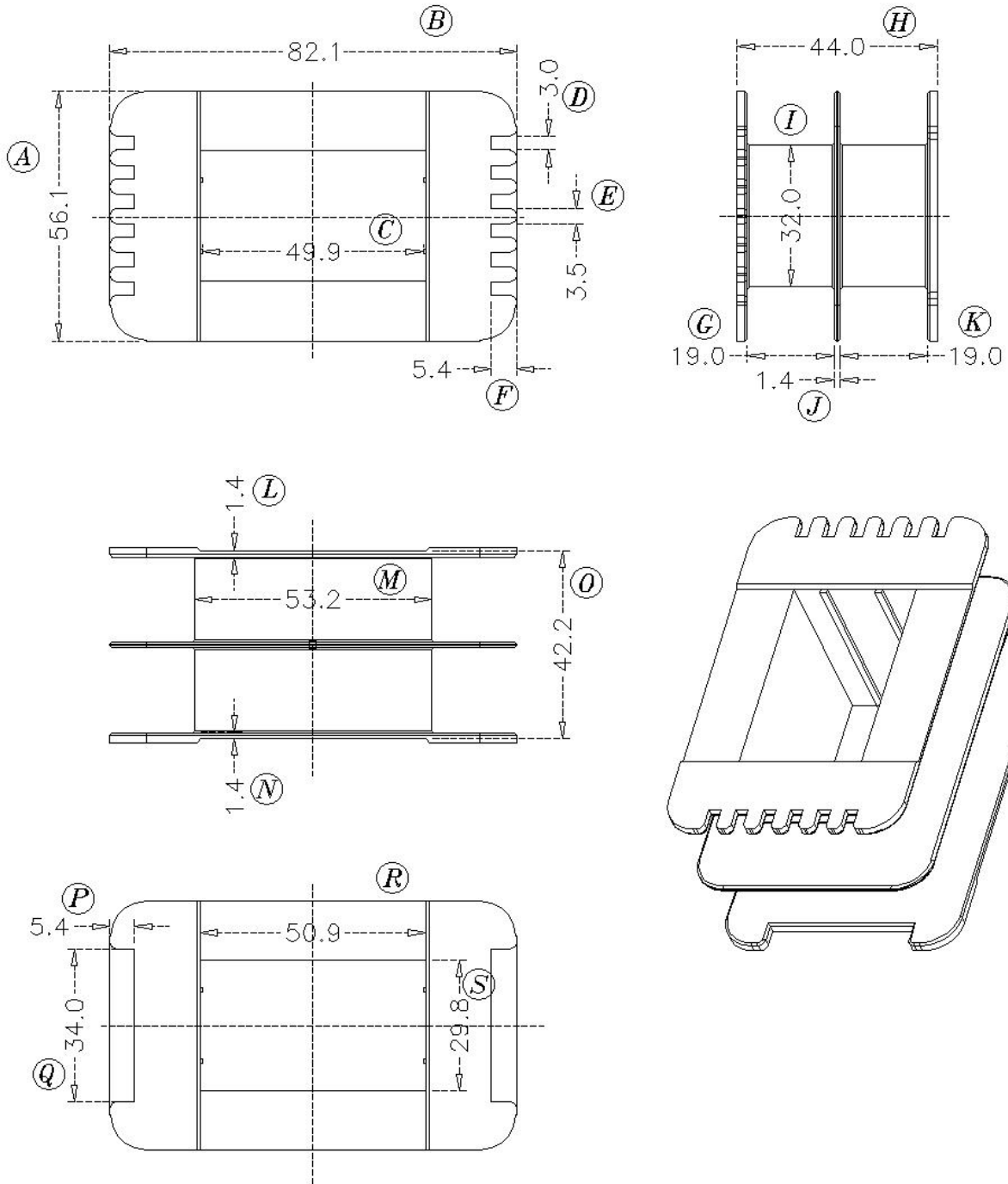

LODESTONE PACIFIC

CHINA FACTORY

www.lodestonepacific.com

Molding Material	UL File No.	Rating	Class
FR50	E41938	UL94-V0	F
Bobbin Part Number			Rev No
B-EIM86X50-2-GFN			1