



Core Fit Reference

0116

EI-41
Metric

EI-50
American

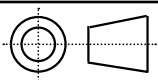
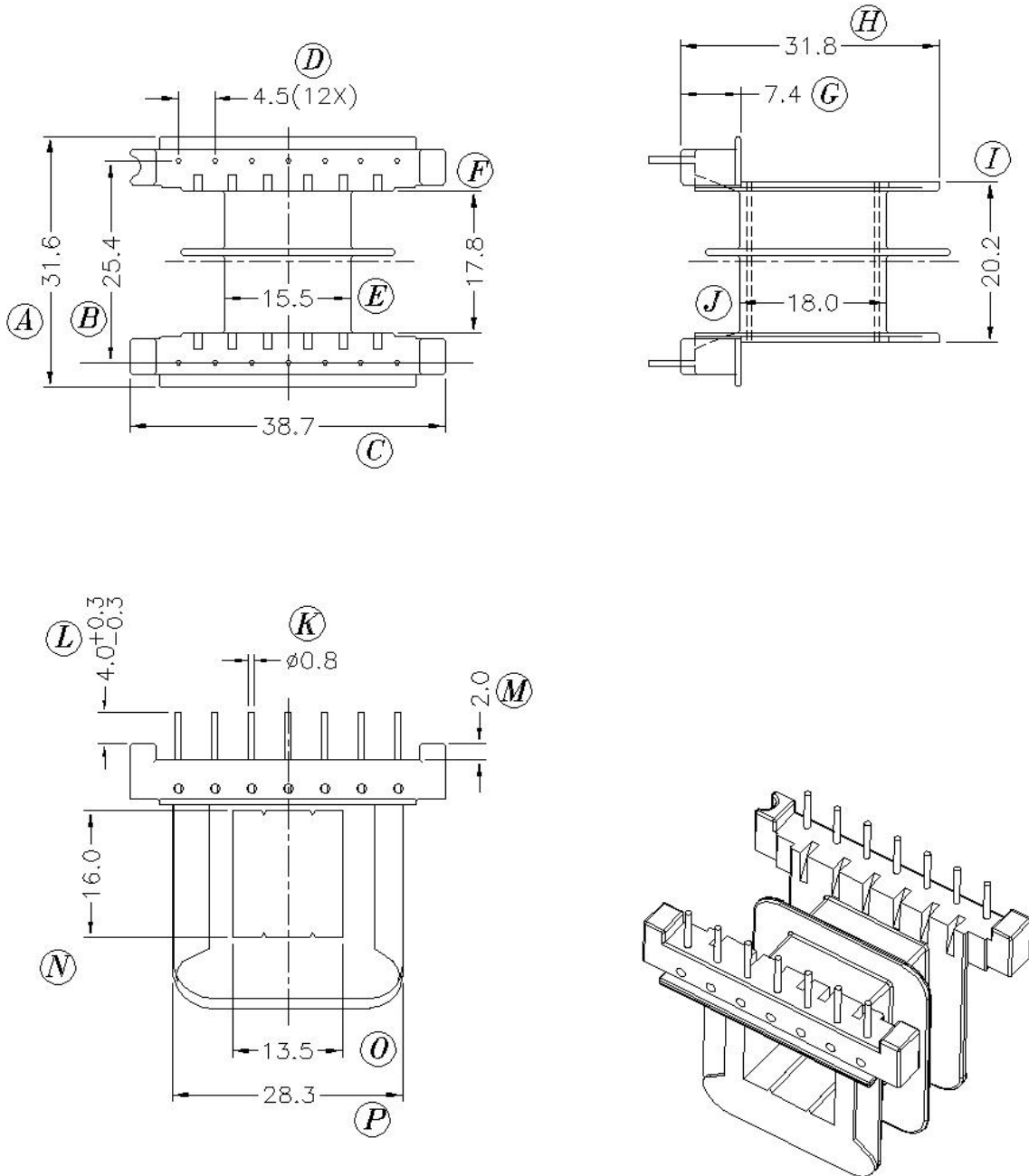

Scale	Tolerance (mm)		
None	0-4mm +/-0.1	4-16mm +/-0.2	16-60mm +/-0.3

Terminal Plating	Terminal Material	No of Terminals	
100% Sn	CP Wire	14	

Molding Material	UL File No.	Rating	Class
FR530	E41938	UL94-V0	N



Bobbin Part Number			Rev No
B-EIM41X16-4H-14-2-PET			1