

2J7A83Bc

4× 5GNR MIMO Screw Mount

Key Features

Cable 1 - 4: 5GNR

- 617-960 MHz
- 1427-2690 MHz
- 3300-5000 MHz
- 5150-5925 MHz

Screw Mount

Heavy Duty antenna

High Performance

Ground Plane Independent

Anti-Rotation Mounting

Customizable Cable and Connector

Dimensions: Ø 96 x H 90 mm

Certificates: IP67, IP69, Ik09



1. Antenna and electrical specifications

Cable 1

Parameters	5G NR Antenna			
Technologies	5G, 4G, 3G and 2G			
Standards	5G NR/4GLTE/FirstNet/CBRS/LPWA/CAT-X/CAT-Mx/CAT-NBx/NB-IoT/3G/2G			
Frequency (MHz)	617-960	1427-2690	3300-5000	5150-5925
Band (MHz)	600, 700, 850, 900	1500, 1600, 1700, 1800, 1900, 2000, 2100, 2300, 2500, 2600	3300, 3500, 3600, 3700, 4500	5200, 5500, 5800
5G NR Bands	n5, n8, 12, n20, n28, n71, n81, n82, n83,	n1, n2, n3, n7, n25, n34, n38, n39, n40, n41, n50, n51, n66, n70, n74, n75, n76, n80, n84, n86	n77, n78, n79	
4GLTE Bands	B5, B6, B8, B12, B13, B14, B17, B18, B19, B20, B26, B27, B28, B29, B44, B67, B68, B71, B85	B1, B2, B3, B4, B7, B9, B10, B11, B21, B23, B24, B25, B30, B32, B33, B34, B35, B36, B37, B38, B39, B40, B41, B45, B50, B51, B65, B66, B69, B70, B74, B75, B76	B22, B42, B43, B48, B49, B52	B46, B47, B252, B255
3GCELL Bands	B5, B6, B8, B12, B13, B14, B19, B20, B26	B1, B2, B3, B4, B7, B9, B10, B11, B21, B25, B32, B33, B34, B35, B36, B37, B38, B39, B40	B22	
2GCELL Bands	710, 750, 810T, 850, 900P, 900E, 900R	1800DCS, 1900PCS		
CDMA CELL Bands	BC0, BC2, BC3, BC7, BC9, BC10, BC12, BC18, BC19	BC1, BC4, BC6, BC8, BC13, BC14, BC15, BC16, BC20, BC21		
Return Loss (dB)	~-5.4	~-12.5	~-11.4	~-12.2
VSWR	~3.6:1	~1.9:1	~1.9:1	~1.8:1
Efficiency (%)	~30.0	~46.5	~42.1	~42.0
Peak Gain (dBi)	~0.1	~3.9	~3.4	~3.9
Average Gain (dB)	~-5.3	~-3.4	~-3.8	~-3.8
Impedance (Ohm)	50			
Polarisation	Linear			
Radiation Pattern	Omni-Directional			
Max. Input Power (W)	35			
Connector Type	SMA-Male Standard (Other Connectors Available)			
Cable Length	300 cm Standard (Any Cable Length Available)			
Cable Type	LL195 Standard (Other Cables Available)			

Cable 2

Parameters	5GNR Antenna			
Technologies	5G, 4G, 3G and 2G			
Standards	5GNR/4GLTE/FirstNet/CBRS/LPWA/CAT-X/CAT-Mx/CAT-NBx/NB-IoT/3G/2G			
Frequency (MHz)	617-960	1427-2690	3300-5000	5150-5925
Band (MHz)	600, 700, 850, 900	1500, 1600, 1700, 1800, 1900, 2000, 2100, 2300, 2500, 2600	3300, 3500, 3600, 3700, 4500	5200, 5500, 5800
5GNR Bands	n5, n8 ,12, n20, n28, n71, n81, n82, n83,	n1, n2, n3, n7, n25, n34, n38, n39, n40, n41, n50, n51, n66, n70, n74, n75, n76, n80, n84, n86	n77, n78, n79	
4GLTE Bands	B5, B6, B8, B12, B13, B14, B17, B18, B19, B20, B26, B27, B28, B29, B44, B67, B68, B71, B85	B1, B2, B3, B4, B7, B9, B10, B11, B21, B23, B24, B25, B30, B32, B33, B34, B35, B36, B37, B38, B39, B40, B41, B45, B50, B51, B65, B66, B69, B70, B74, B75, B76	B22, B42, B43, B48, B49, B52	B46, B47, B252, B255
3GCELL Bands	B5, B6, B8, B12, B13, B14, B19, B20, B26	B1, B2, B3, B4, B7, B9, B10, B11, B21, B25, B32, B33, B34, B35, B36, B37, B38, B39, B40	B22	
2GCELL Bands	710, 750, 810T, 850, 900P, 900E, 900R	1800DCS, 1900PCS		
CDMACELL Bands	BC0, BC2, BC3, BC7, BC9, BC10, BC12, BC18, BC19	BC1, BC4, BC6, BC8, BC13, BC14, BC15, BC16, BC20, BC21		
Return Loss (dB)	~-5.8	~-13.2	~-12.5	~-12.8
VSWR	~3.4:1	~1.8:1	~1.8:1	~1.7:1
Efficiency (%)	~31.1	~47.6	~40.9	~41.0
Peak Gain (dBi)	~-1.3	~-4.0	~-3.0	~-3.6
Average Gain (dB)	~-5.1	~-3.3	~-3.9	~-3.9
Impedance (Ohm)	50			
Polarisation	Linear			
Radiation Pattern	Omni-Directional			
Max. Input Power (W)	35			
Connector Type	SMA-Male Standard (Other Connectors Available)			
Cable Length	300 cm Standard (Any Cable Length Available)			
Cable Type	LL195 Standard (Other Cables Available)			

Cable 3

Parameters	5G NR Antenna			
Technologies	5G, 4G, 3G and 2G			
Standards	5G NR/4GLTE/FirstNet/CBRS/LPWA/CAT-X/CAT-Mx/CAT-NBx/NB-IoT/3G/2G			
Frequency (MHz)	617-960	1427-2690	3300-5000	5150-5925
Band (MHz)	600, 700, 850, 900	1500, 1600, 1700, 1800, 1900, 2000, 2100, 2300, 2500, 2600	3300, 3500, 3600, 3700, 4500	5200, 5500, 5800
5G NR Bands	n5, n8, 12, n20, n28, n71, n81, n82, n83,	n1, n2, n3, n7, n25, n34, n38, n39, n40, n41, n50, n51, n66, n70, n74, n75, n76, n80, n84, n86	n77, n78, n79	
4GLTE Bands	B5, B6, B8, B12, B13, B14, B17, B18, B19, B20, B26, B27, B28, B29, B44, B67, B68, B71, B85	B1, B2, B3, B4, B7, B9, B10, B11, B21, B23, B24, B25, B30, B32, B33, B34, B35, B36, B37, B38, B39, B40, B41, B45, B50, B51, B65, B66, B69, B70, B74, B75, B76	B22, B42, B43, B48, B49, B52	B46, B47, B252, B255
3GCELL Bands	B5, B6, B8, B12, B13, B14, B19, B20, B26	B1, B2, B3, B4, B7, B9, B10, B11, B21, B25, B32, B33, B34, B35, B36, B37, B38, B39, B40	B22	
2GCELL Bands	710, 750, 810T, 850, 900P, 900E, 900R	1800DCS, 1900PCS		
CDMA CELL Bands	BC0, BC2, BC3, BC7, BC9, BC10, BC12, BC18, BC19	BC1, BC4, BC6, BC8, BC13, BC14, BC15, BC16, BC20, BC21		
Return Loss (dB)	~-5.0	~-12.3	~-11.9	~-11.8
VSWR	~4.1:1	~1.9:1	~1.9:1	~1.9:1
Efficiency (%)	~30.0	~47.0	~41.9	~44.4
Peak Gain (dBi)	~-0.7	~3.8	~3.6	~4.0
Average Gain (dB)	~-5.4	~-3.4	~-3.8	~-3.5
Impedance (Ohm)	50			
Polarisation	Linear			
Radiation Pattern	Omni-Directional			
Max. Input Power (W)	35			
Connector Type	SMA-Male Standard (Other Connectors Available)			
Cable Length	300 cm Standard (Any Cable Length Available)			
Cable Type	LL195 Standard (Other Cables Available)			

Cable 4

Parameters	5GNR Antenna			
Technologies	5G, 4G, 3G and 2G			
Standards	5GNR/4GLTE/FirstNet/CBRS/LPWA/CAT-X/CAT-Mx/CAT-NBx/NB-IoT/3G/2G			
Frequency (MHz)	617-960	1427-2690	3300-5000	5150-5925
Band (MHz)	600, 700, 850, 900	1500, 1600, 1700, 1800, 1900, 2000, 2100, 2300, 2500, 2600	3300, 3500, 3600, 3700, 4500	5200, 5500, 5800
5GNR Bands	n5, n8 ,12, n20, n28, n71, n81, n82, n83,	n1, n2, n3, n7, n25, n34, n38, n39, n40, n41, n50, n51, n66, n70, n74, n75, n76, n80, n84, n86	n77, n78, n79	
4GLTE Bands	B5, B6, B8, B12, B13, B14, B17, B18, B19, B20, B26, B27, B28, B29, B44, B67, B68, B71, B85	B1, B2, B3, B4, B7, B9, B10, B11, B21, B23, B24, B25, B30, B32, B33, B34, B35, B36, B37, B38, B39, B40, B41, B45, B50, B51, B65, B66, B69, B70, B74, B75, B76	B22, B42, B43, B48, B49, B52	B46, B47, B252, B255
3GCELL Bands	B5, B6, B8, B12, B13, B14, B19, B20, B26	B1, B2, B3, B4, B7, B9, B10, B11, B21, B25, B32, B33, B34, B35, B36, B37, B38, B39, B40	B22	
2GCELL Bands	710, 750, 810T, 850, 900P, 900E, 900R	1800DCS, 1900PCS		
CDMACELL Bands	BC0, BC2, BC3, BC7, BC9, BC10, BC12, BC18, BC19	BC1, BC4, BC6, BC8, BC13, BC14, BC15, BC16, BC20, BC21		
Return Loss (dB)	~-5.5	~-12.7	~-11.8	~-12.7
VSWR	~3.7:1	~1.9:1	~1.9:1	~1.9:1
Efficiency (%)	~30.6	~46.3	~42.1	~42.1
Peak Gain (dBi)	~-0.9	~3.6	~3.3	~4.3
Average Gain (dB)	~-5.2	~-3.4	~-3.8	~-3.8
Impedance (Ohm)	50			
Polarisation	Linear			
Radiation Pattern	Omni-Directional			
Max. Input Power (W)	35			
Connector Type	SMA-Male Standard (Other Connectors Available)			
Cable Length	300 cm Standard (Any Cable Length Available)			
Cable Type	LL195 Standard (Other Cables Available)			

Antenna Measurement Conditions:

Mounted on Metal Plate of 30 x 30 cm
 200 cm of Cable LL195
 Measured in Certified CTIA 3D Anechoic Chamber

2. Mechanical and environmental specifications

Specifications	2J7A83Bc
Mounting Type	Screw Mount
Dimensions (mm)	Ø 96 x H 90
Max. Tighten Torque (Nm)	6 Nm
Radome	ASA
Radome color	White, Black
Antenna Base	ASA
Operating Temperature (C)	-40 to +85
Storage Temperature (C)	-40 to +85
Substance Compliance	RoHS
Certificates	IP67, IP69, Ik09

3. Antenna parameters

Cable 1: 5GNR

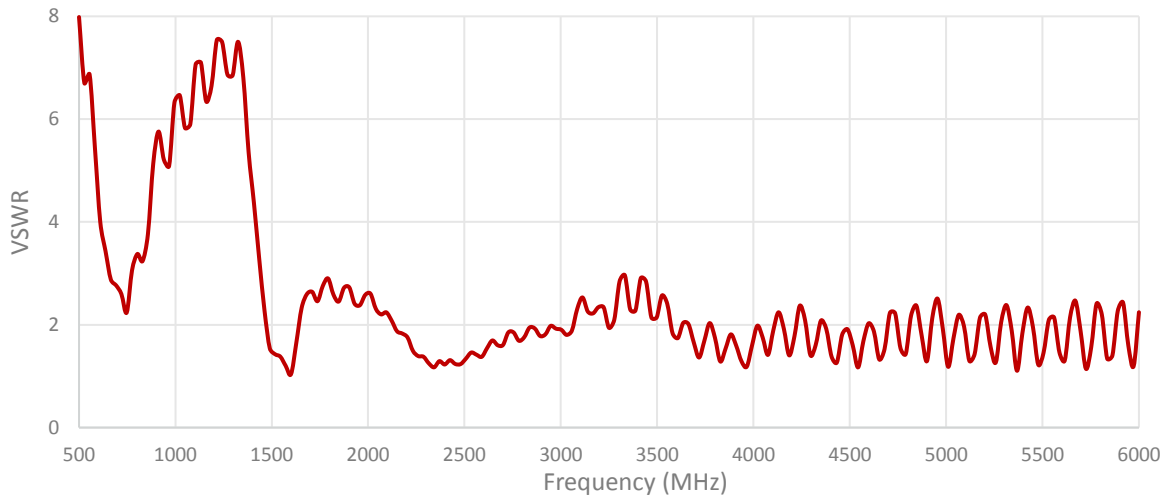
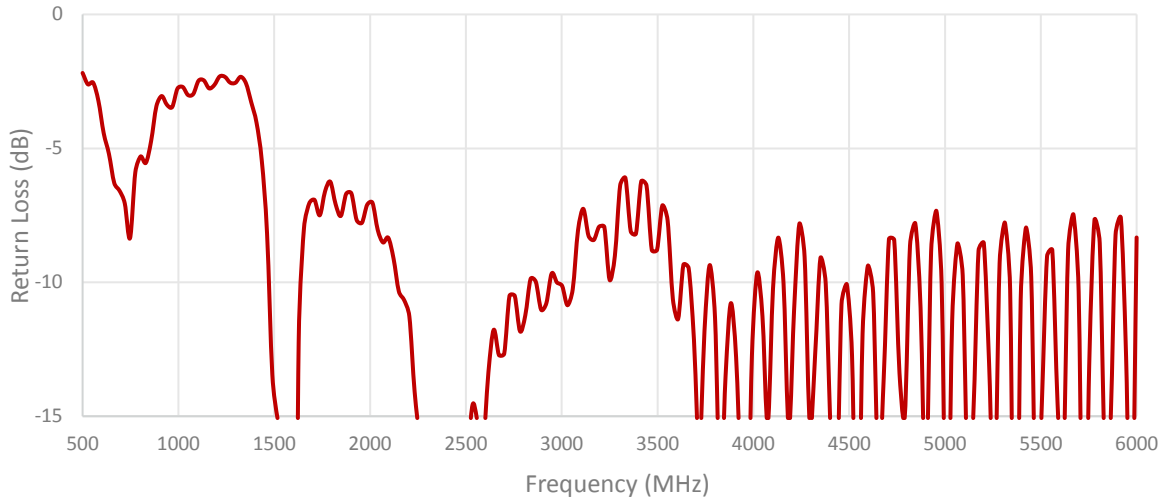

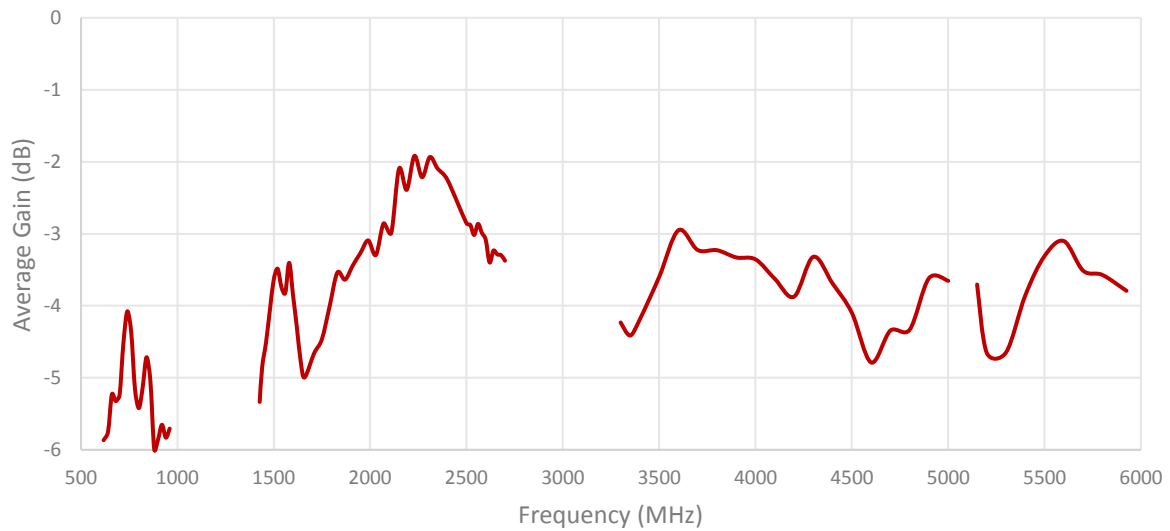
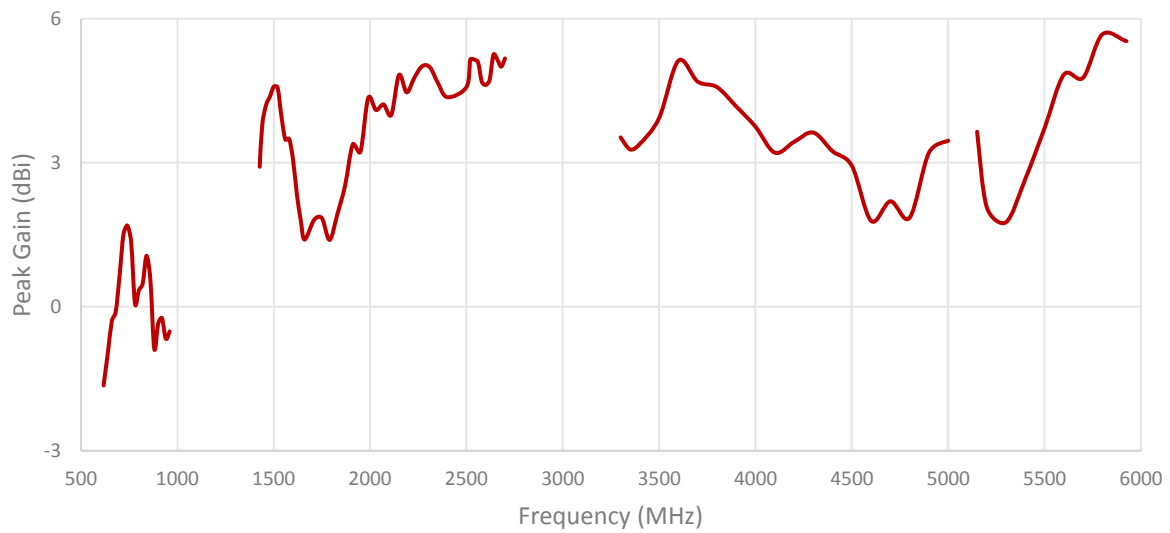
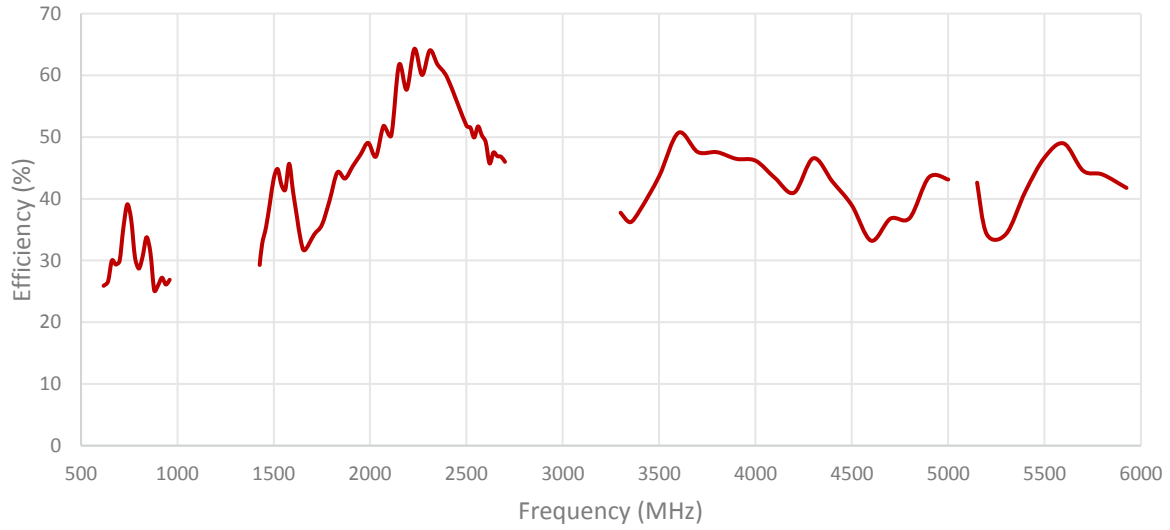

Cable 2: 5GNR

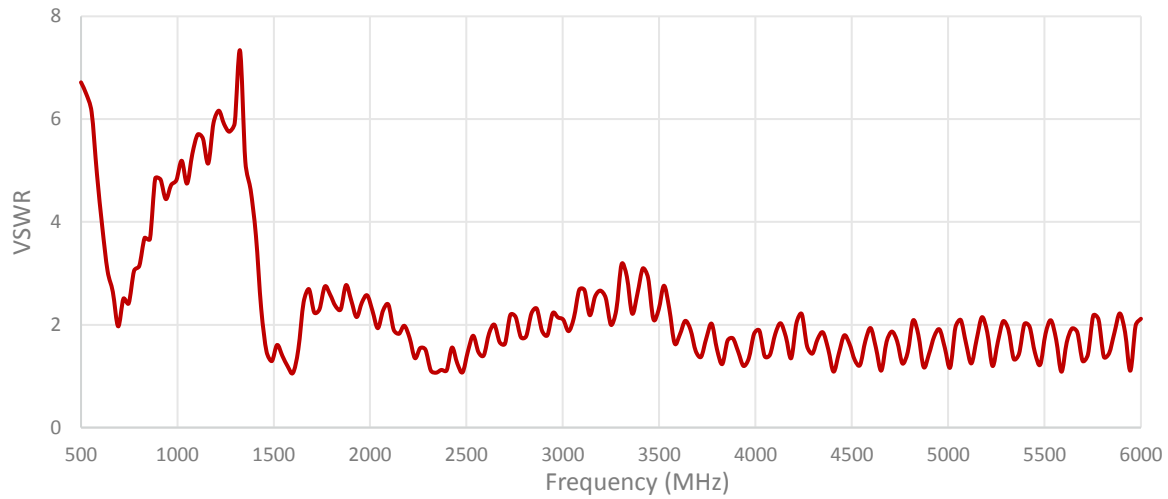
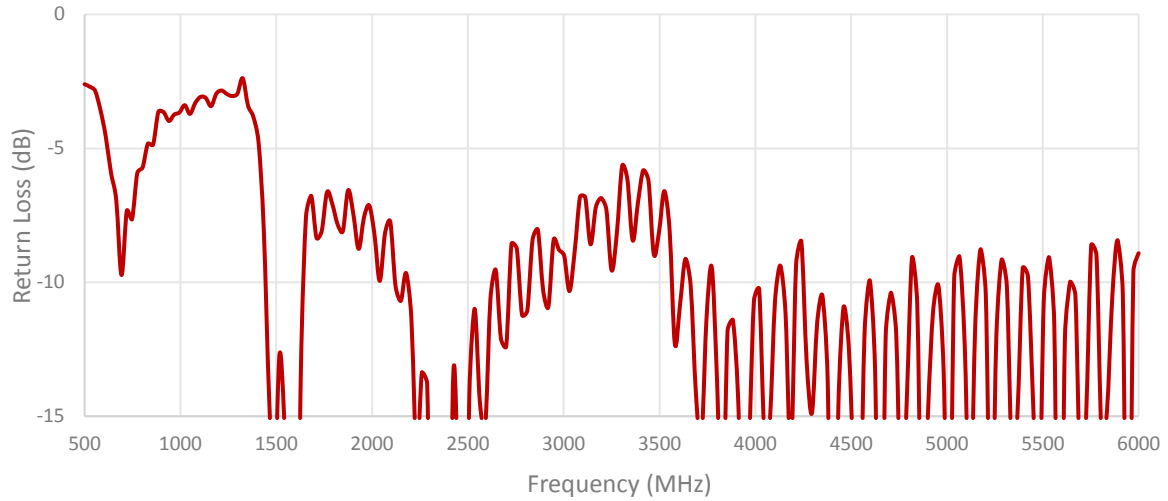

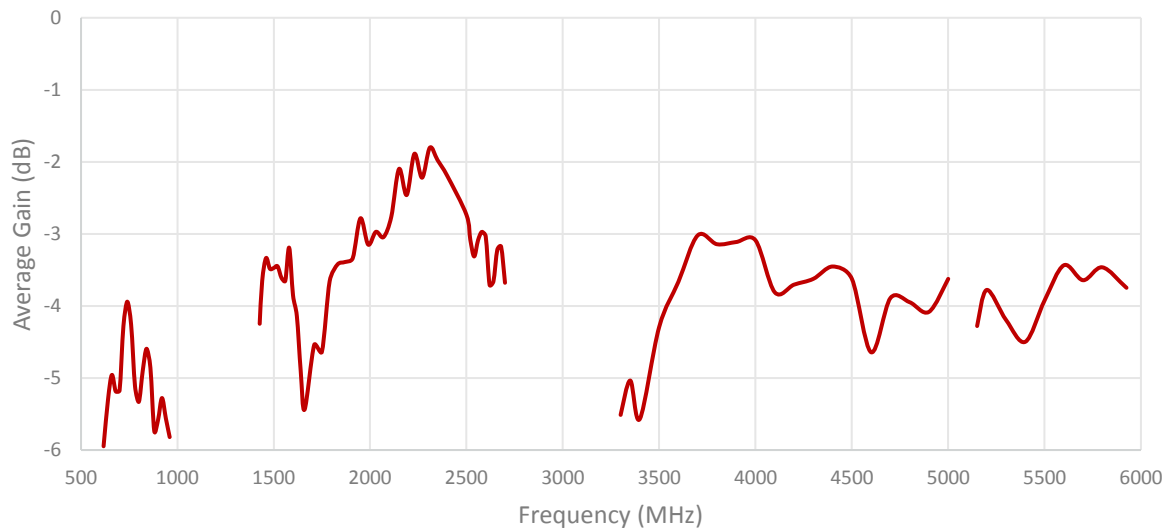
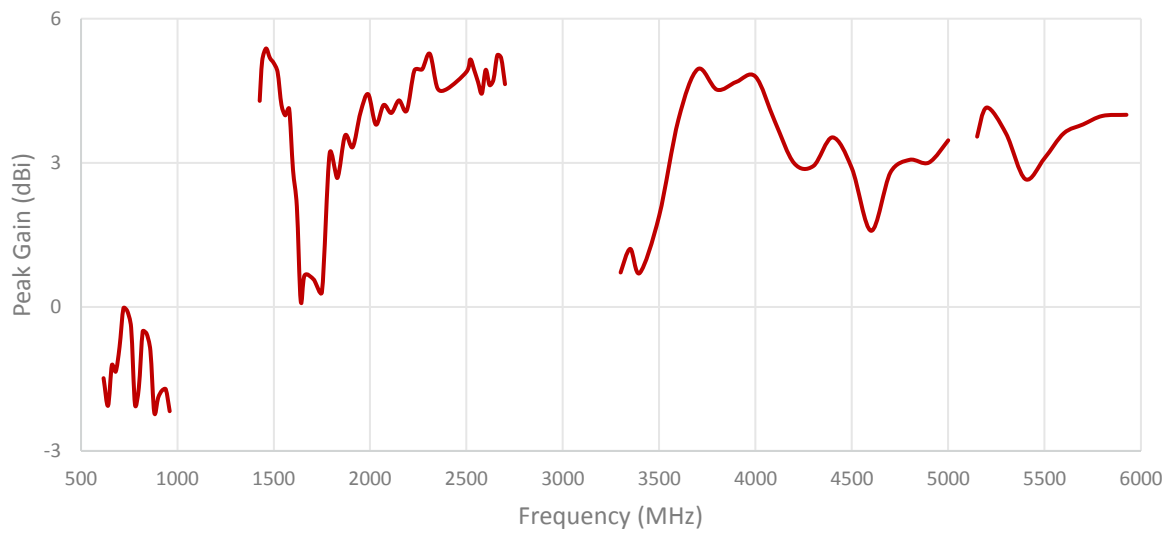
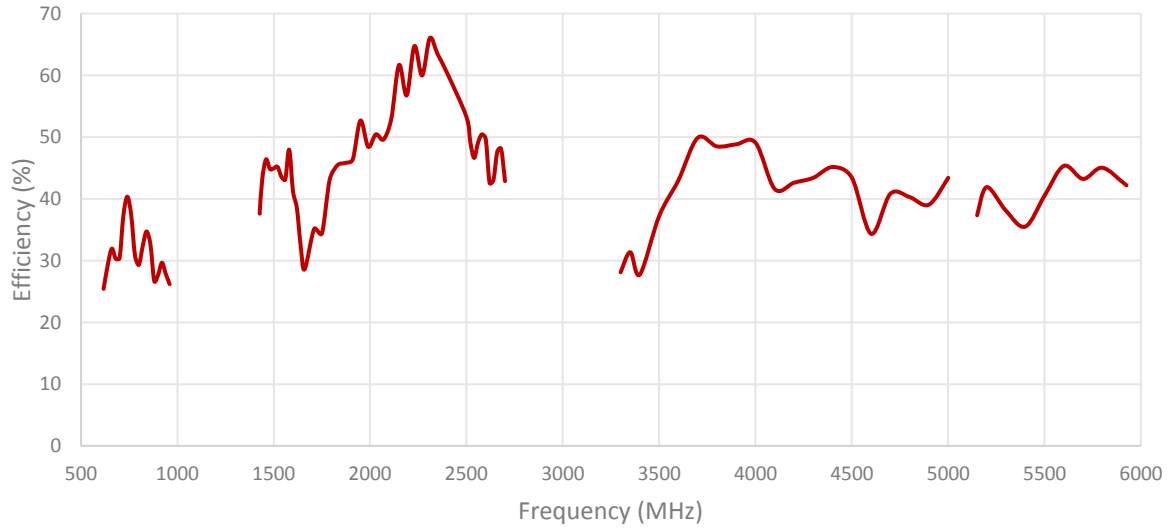

Cable 3: 5GNR

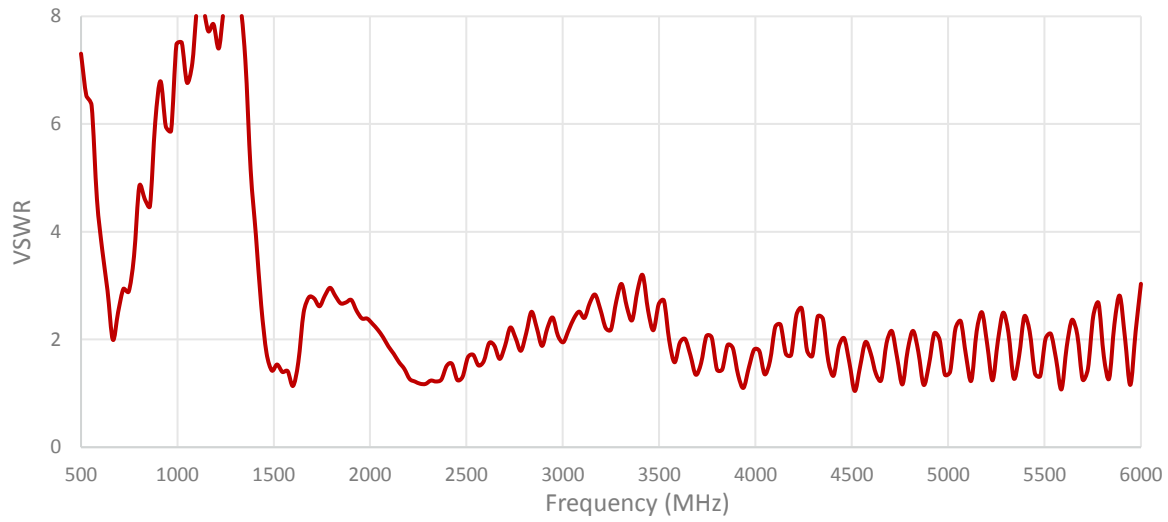
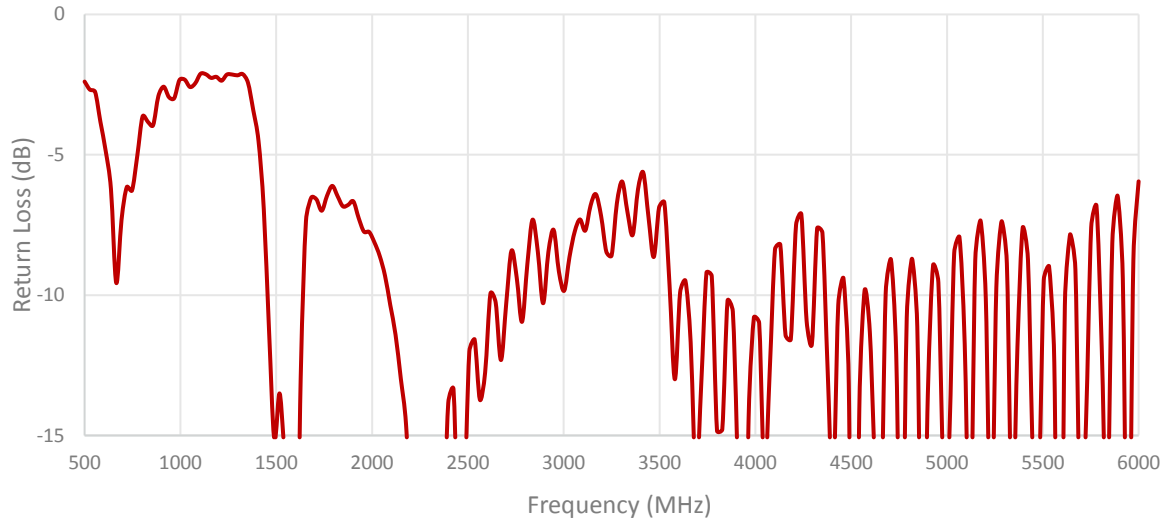

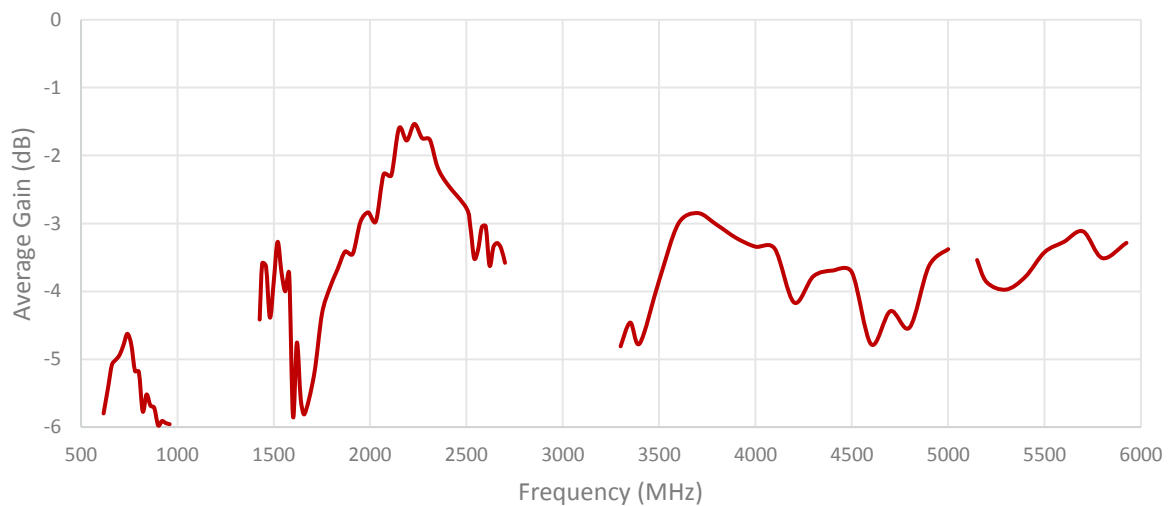
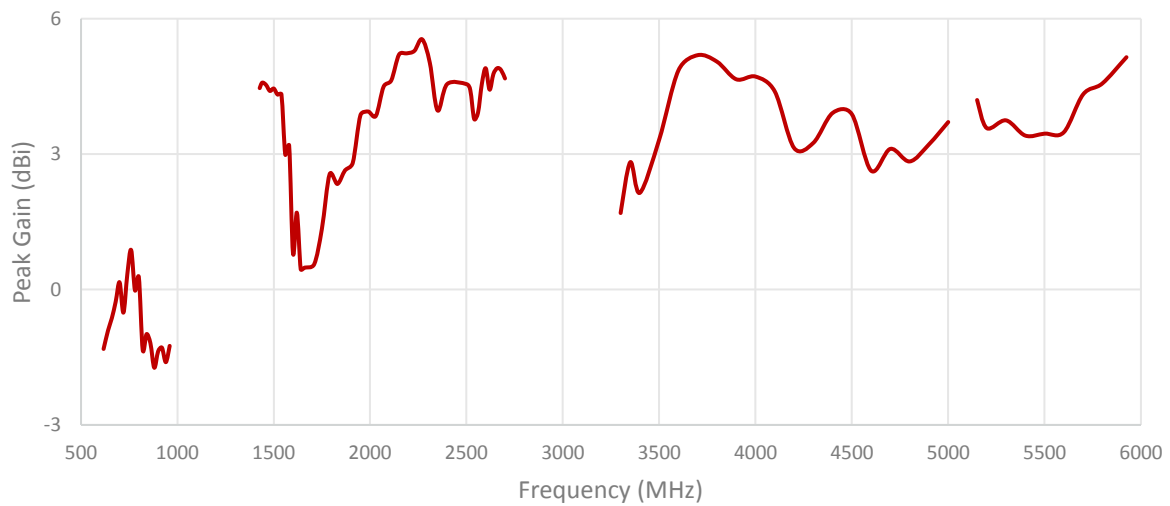
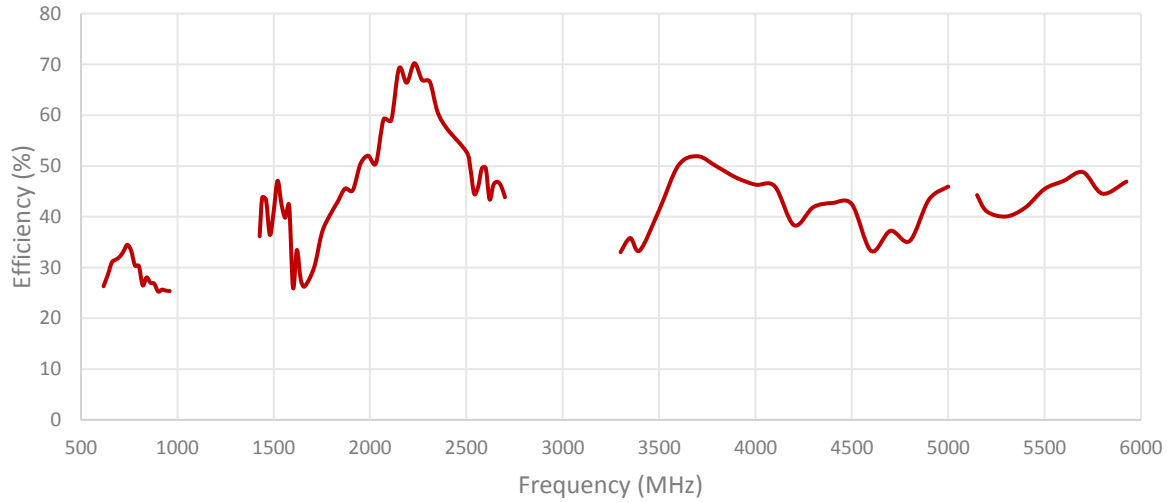

Cable 4: 5GNR

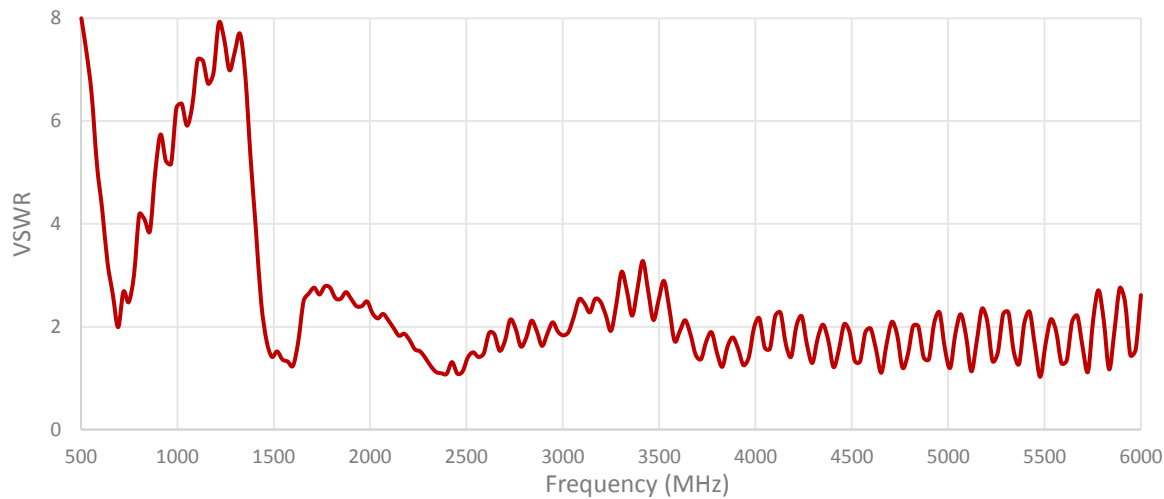
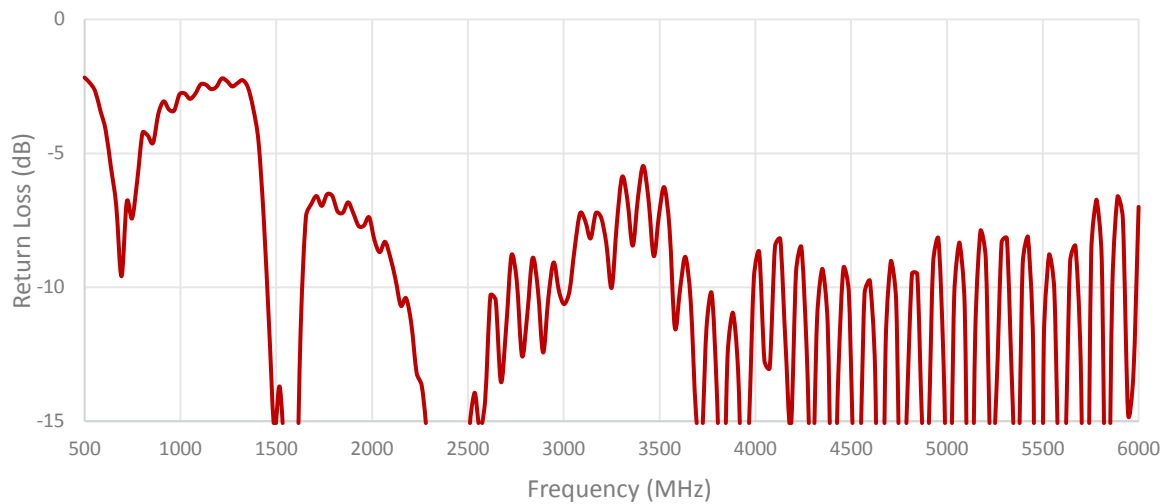

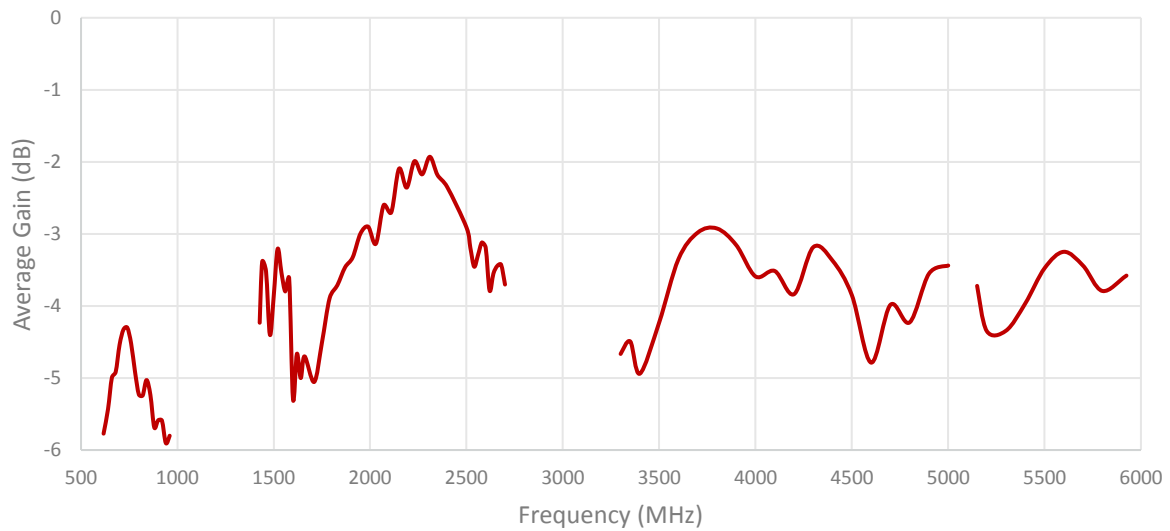
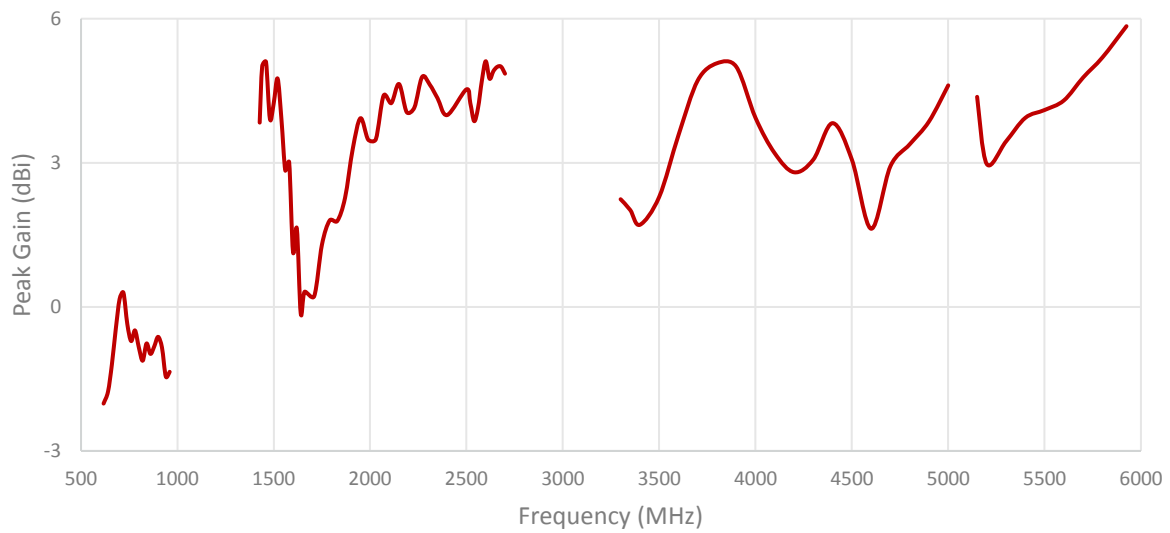
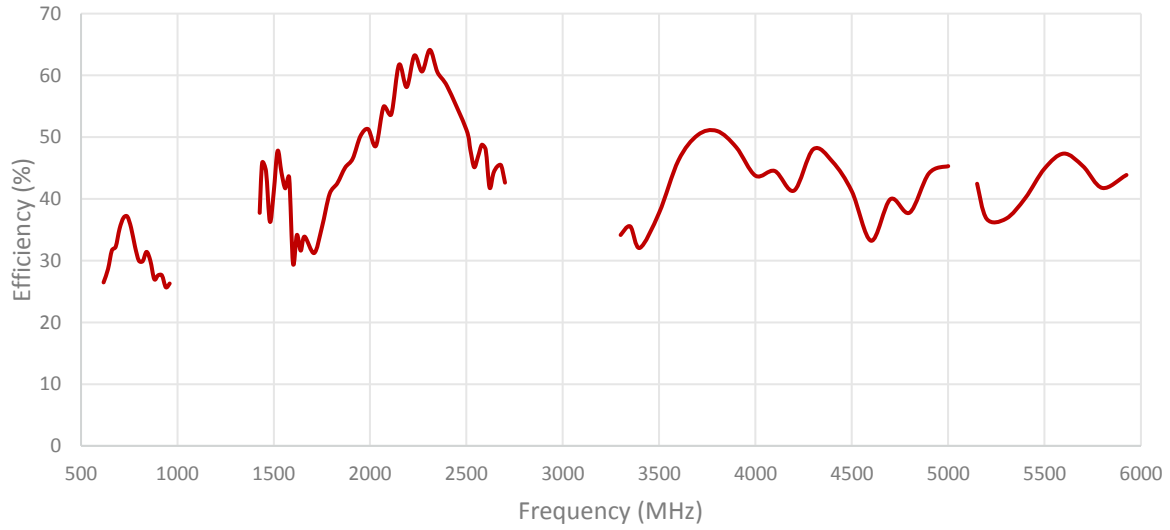

ISOLATION FOR CABLES 1 AND 2

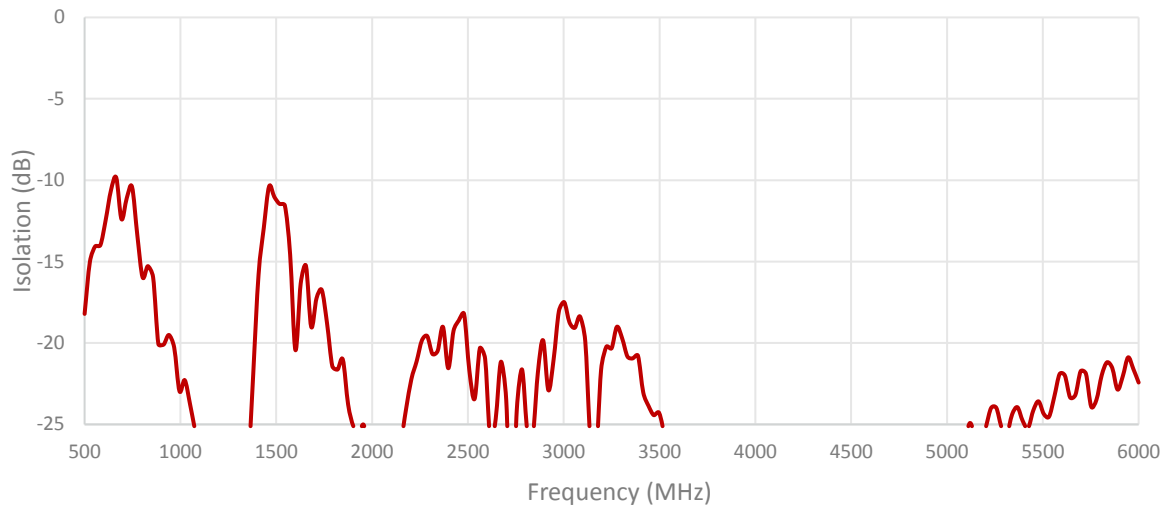

ISOLATION FOR CABLES 1 AND 3

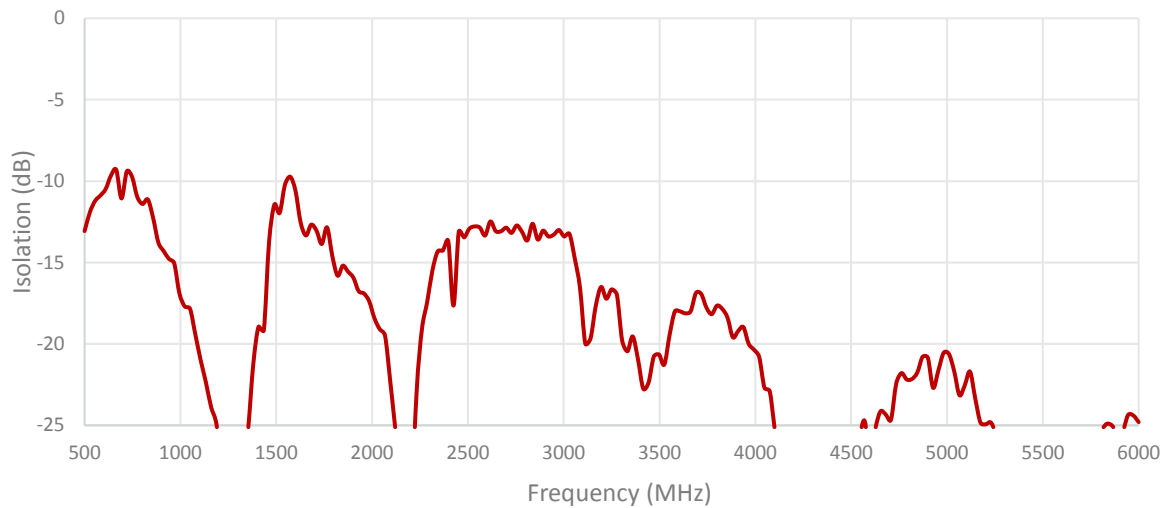

1

ISOLATION FOR CABLES 1 AND 4

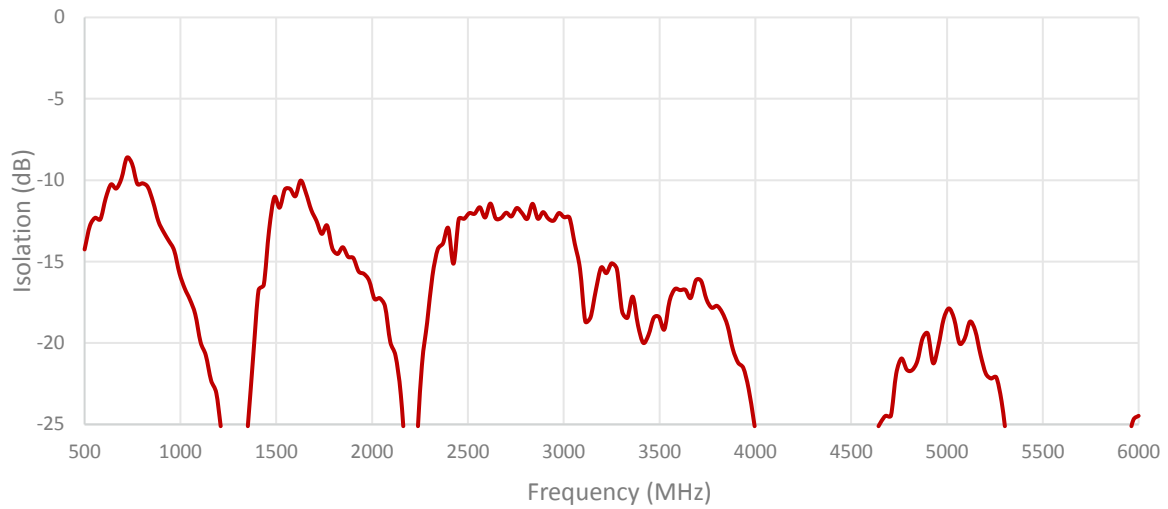

ISOLATION FOR CABLES 2 AND 3

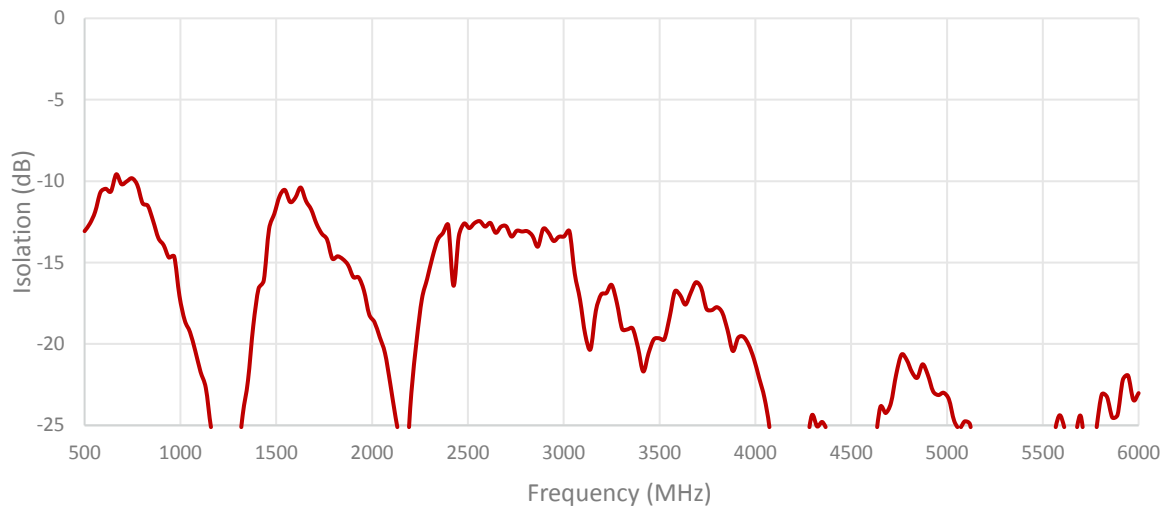

ISOLATION FOR CABLES 2 AND 4

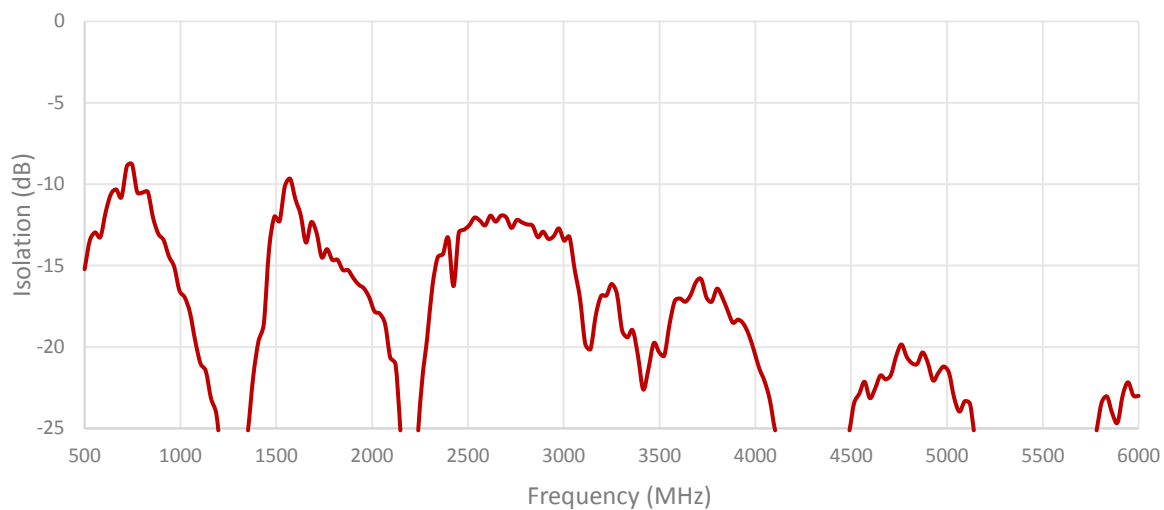

ISOLATION FOR CABLES 3 AND 4

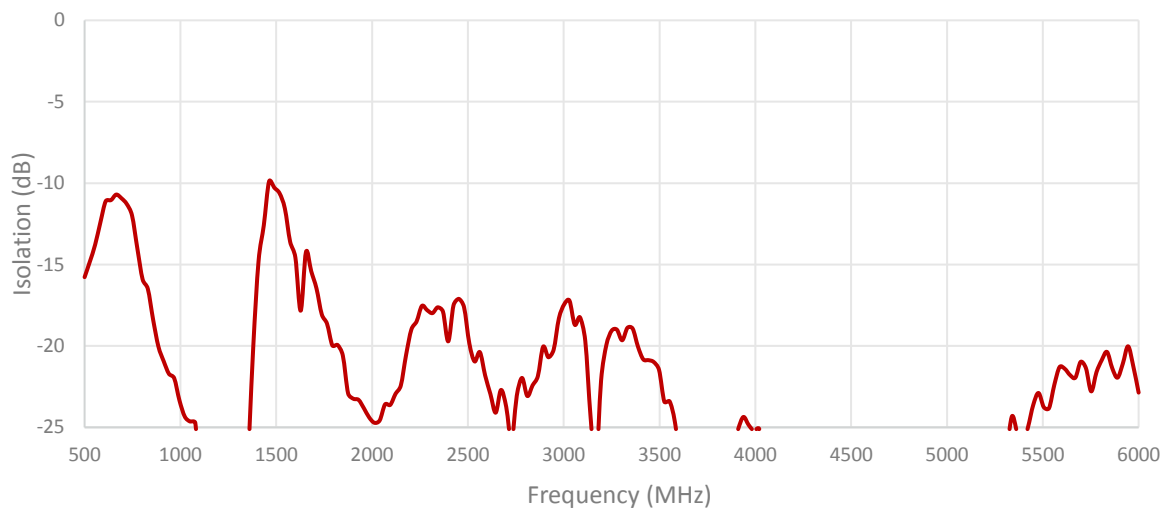

ENVELOPE CORRELATION COEFFICIENT FOR CABLES 1 AND 2

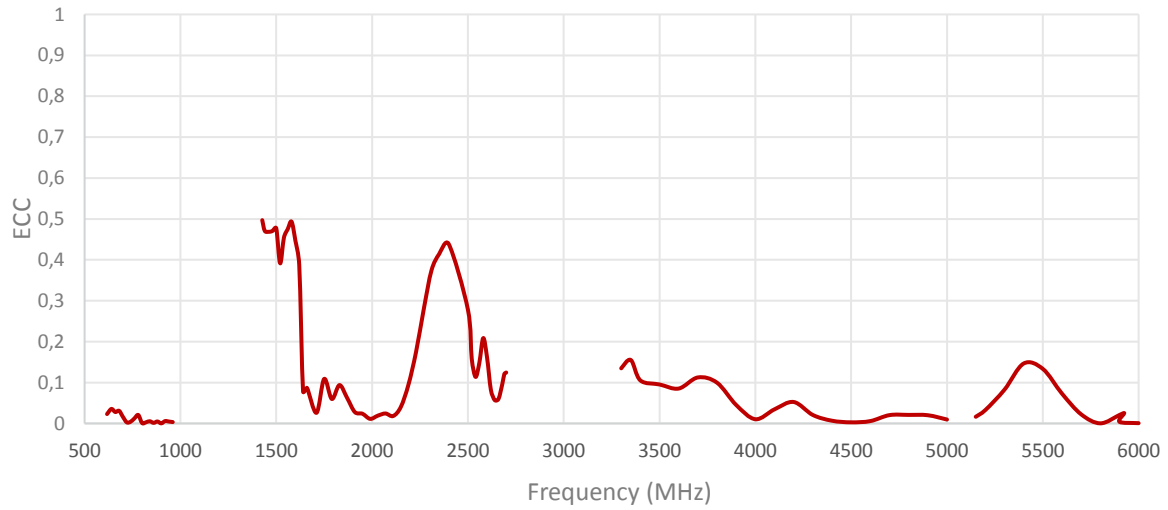

ENVELOPE CORRELATION COEFFICIENT FOR CABLES 1 AND 3

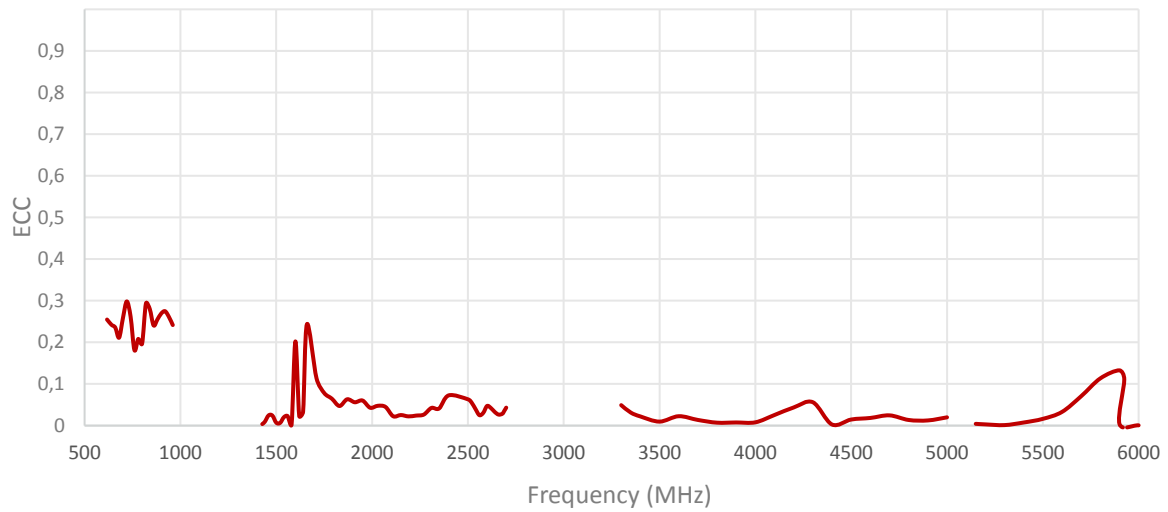

ENVELOPE CORRELATION COEFFICIENT FOR CABLES 1 AND 4

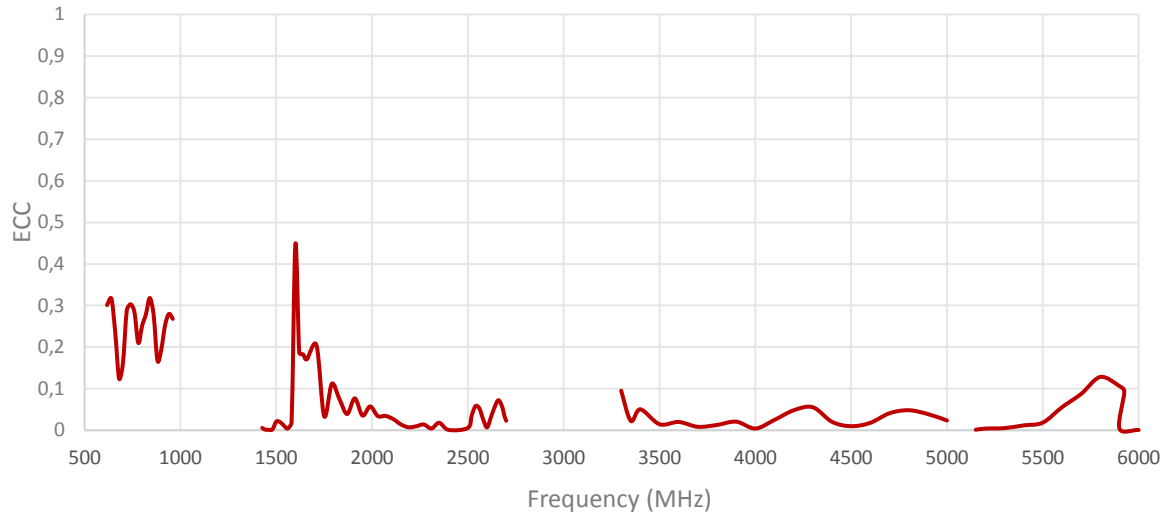

ENVELOPE CORRELATION COEFFICIENT FOR CABLES 2 AND 3

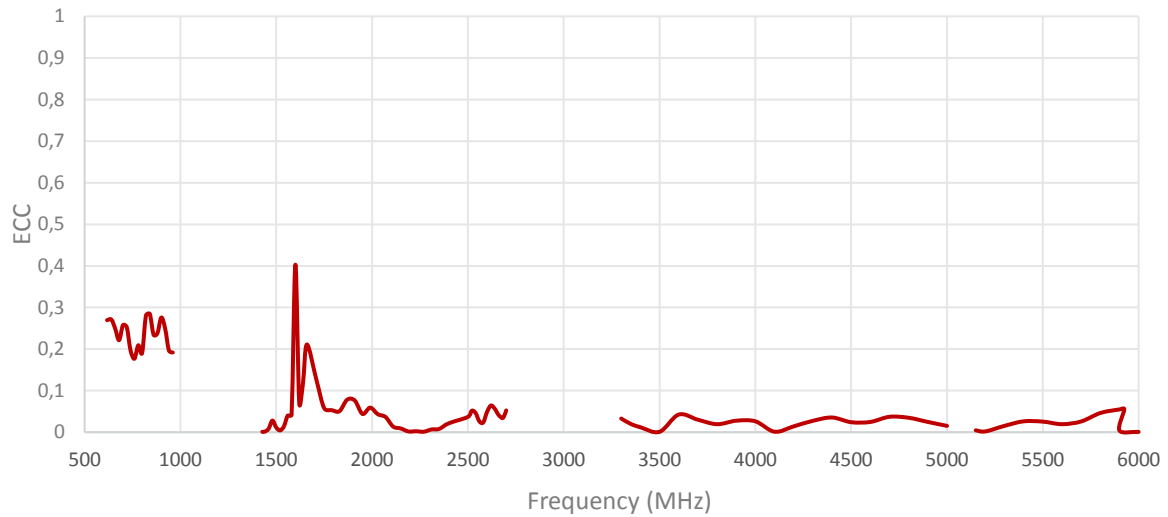

ENVELOPE CORRELATION COEFFICIENT FOR CABLES 2 AND 4

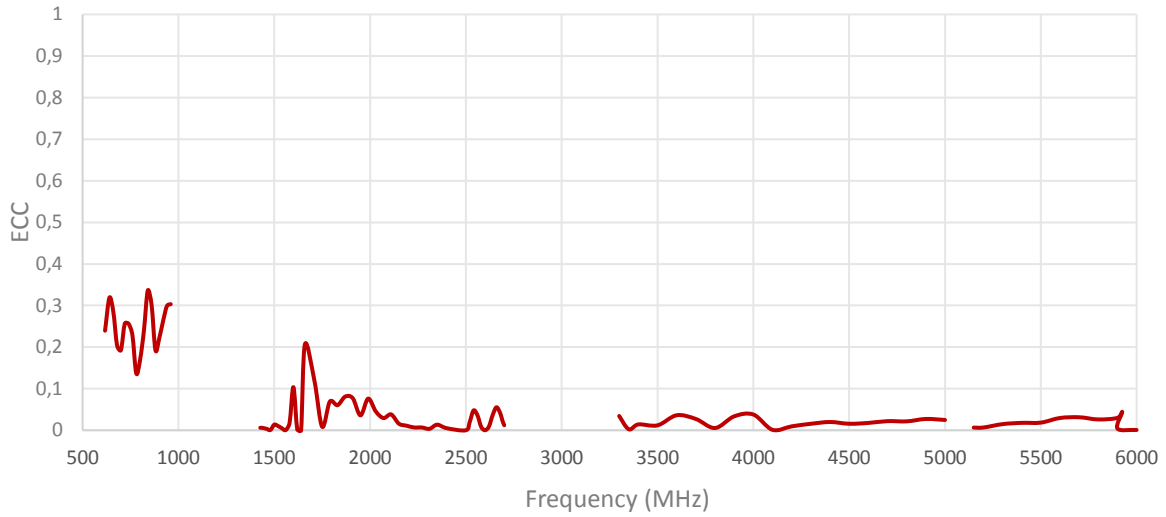

ENVELOPE CORRELATION COEFFICIENT FOR CABLES 3 AND 4

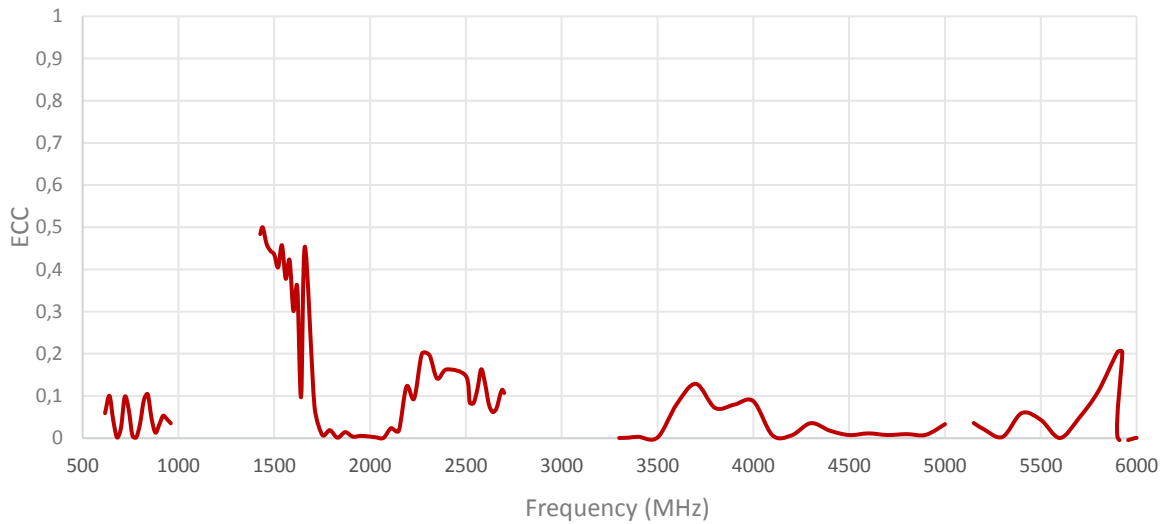



Radiation pattern reference

Cable 1: 5GNR

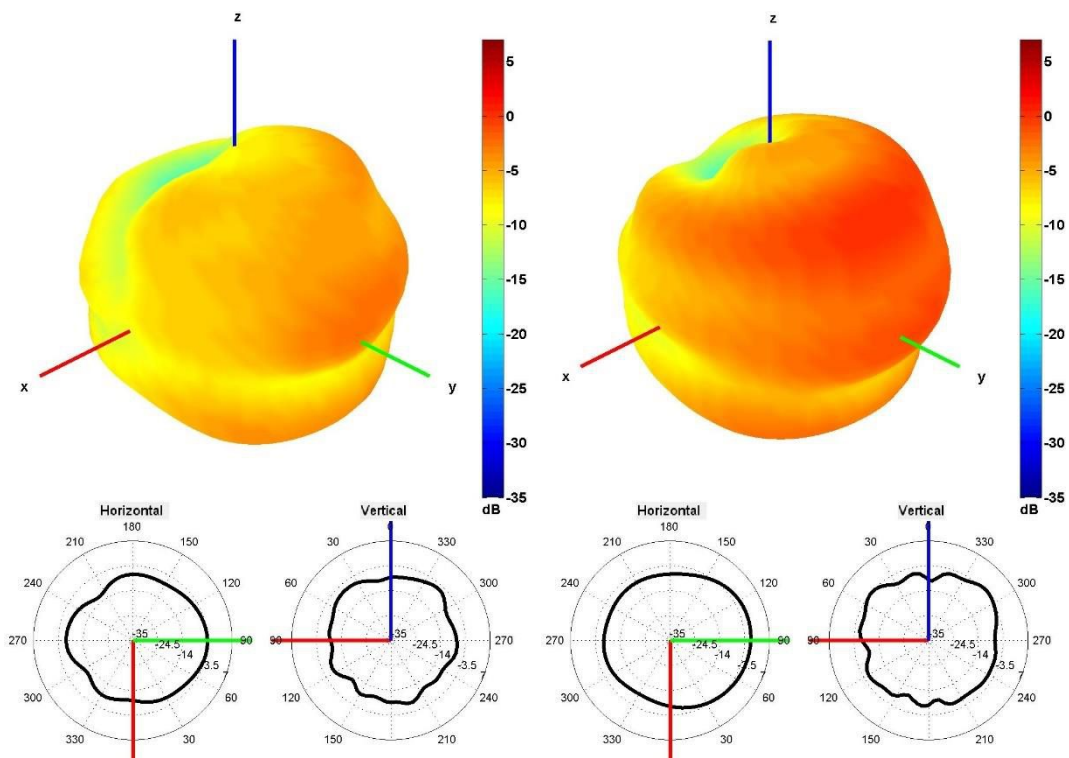

750 and 2500 MHz Radiation pattern

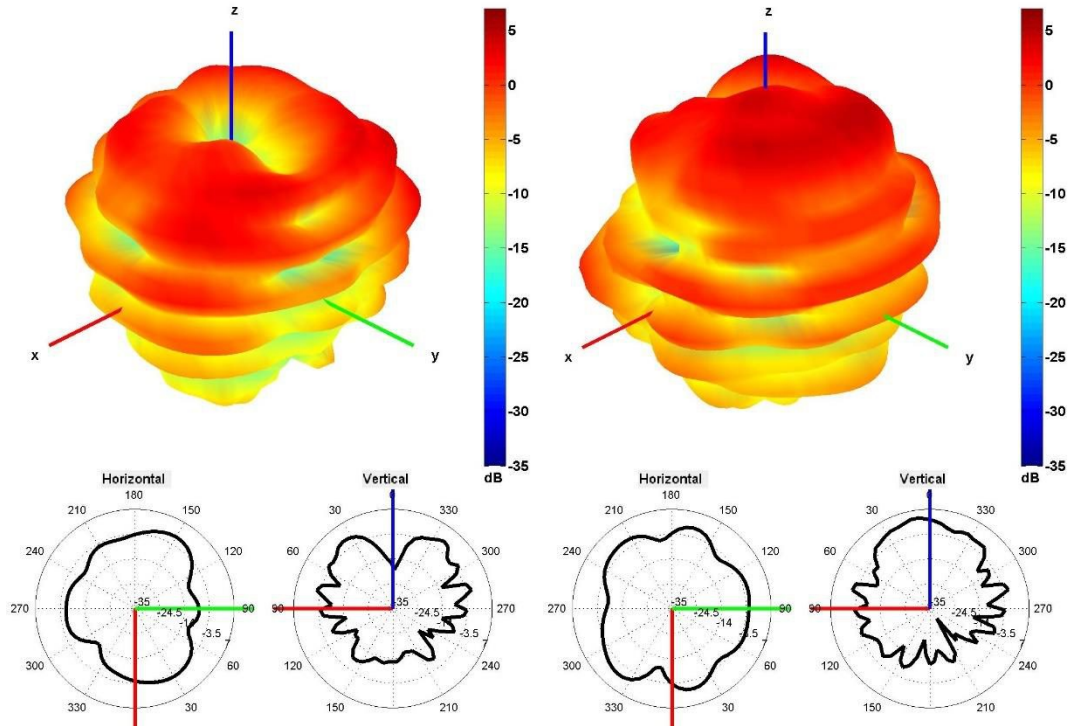

Cable 2: 5GNR

4500 and 5500 MHz Radiation pattern

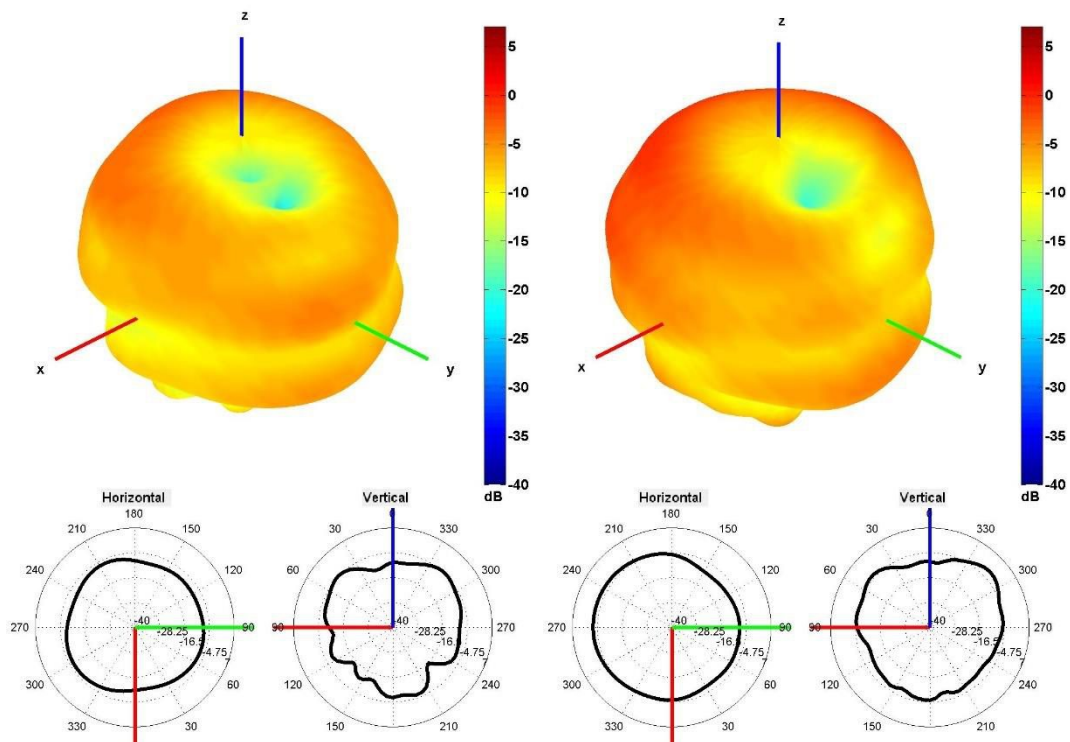

750 and 2500 MHz Radiation pattern

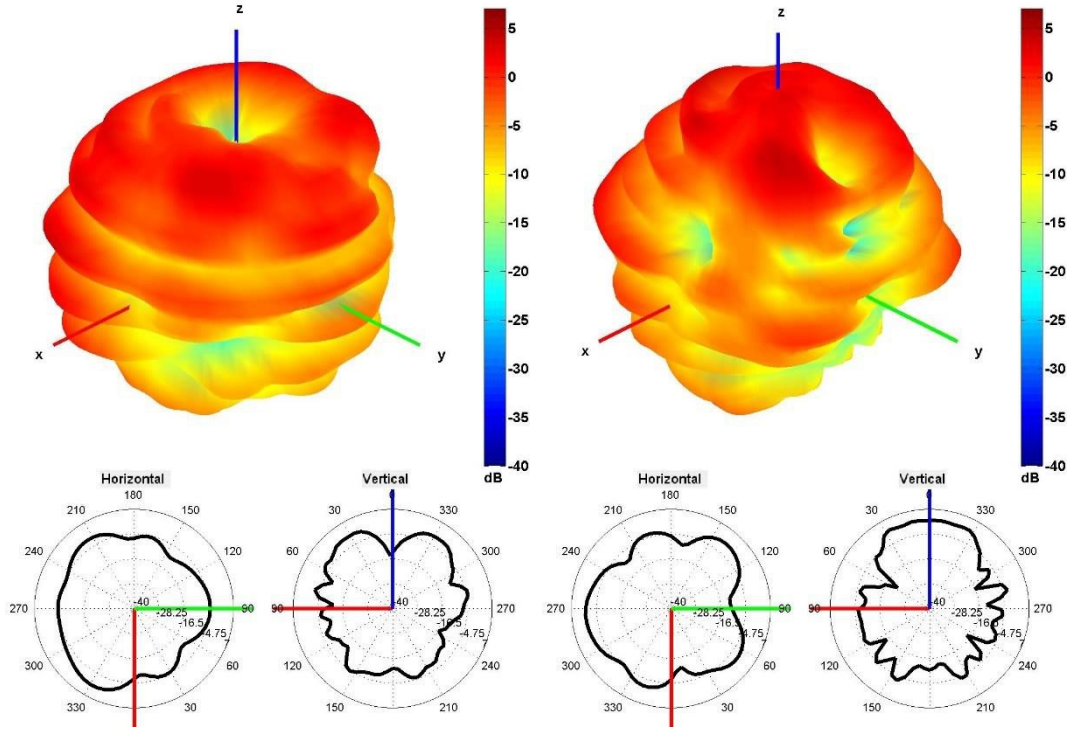

Cable 3: 5GNR

4500 and 5500 MHz Radiation pattern

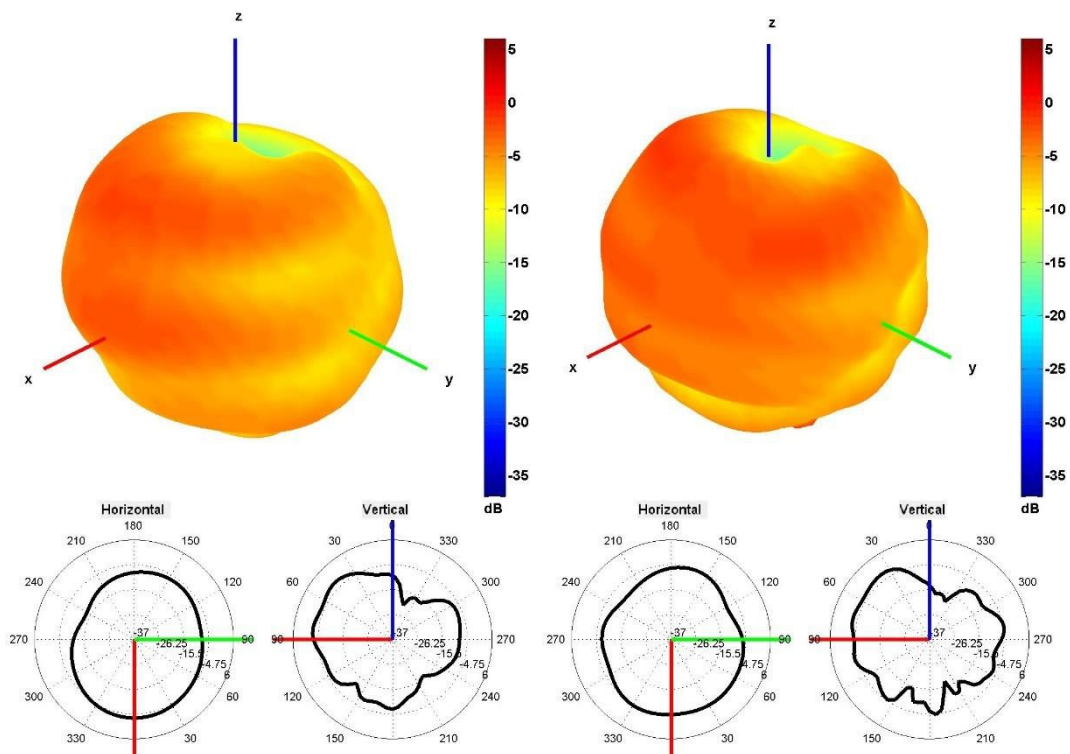

750 and 2500 MHz Radiation pattern

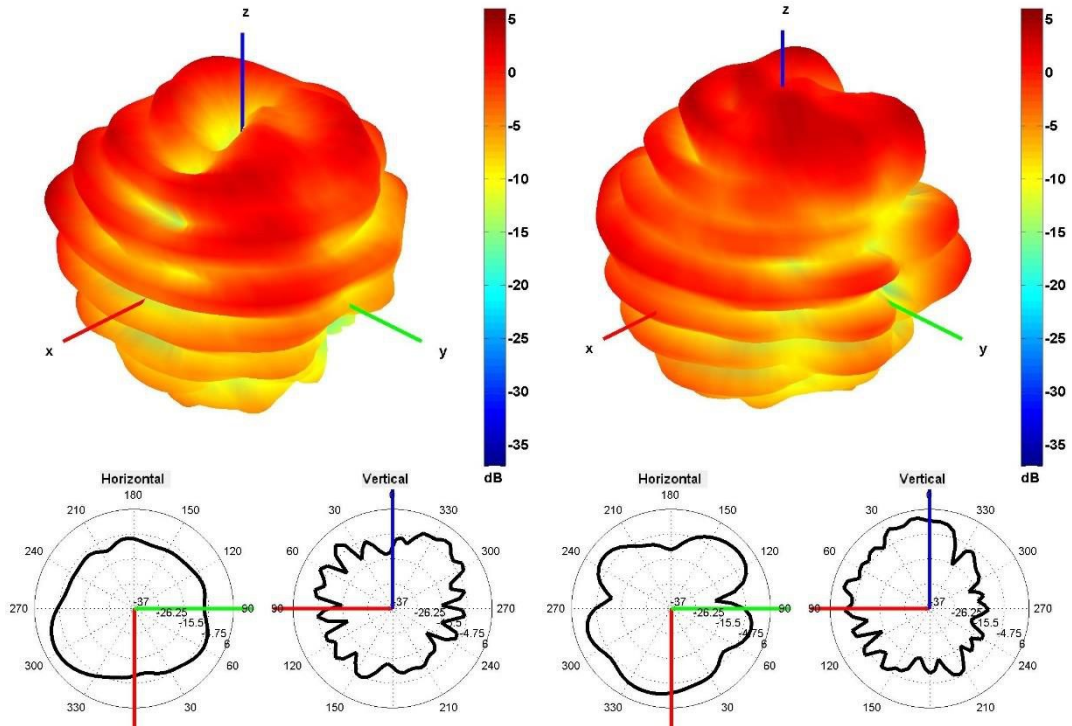
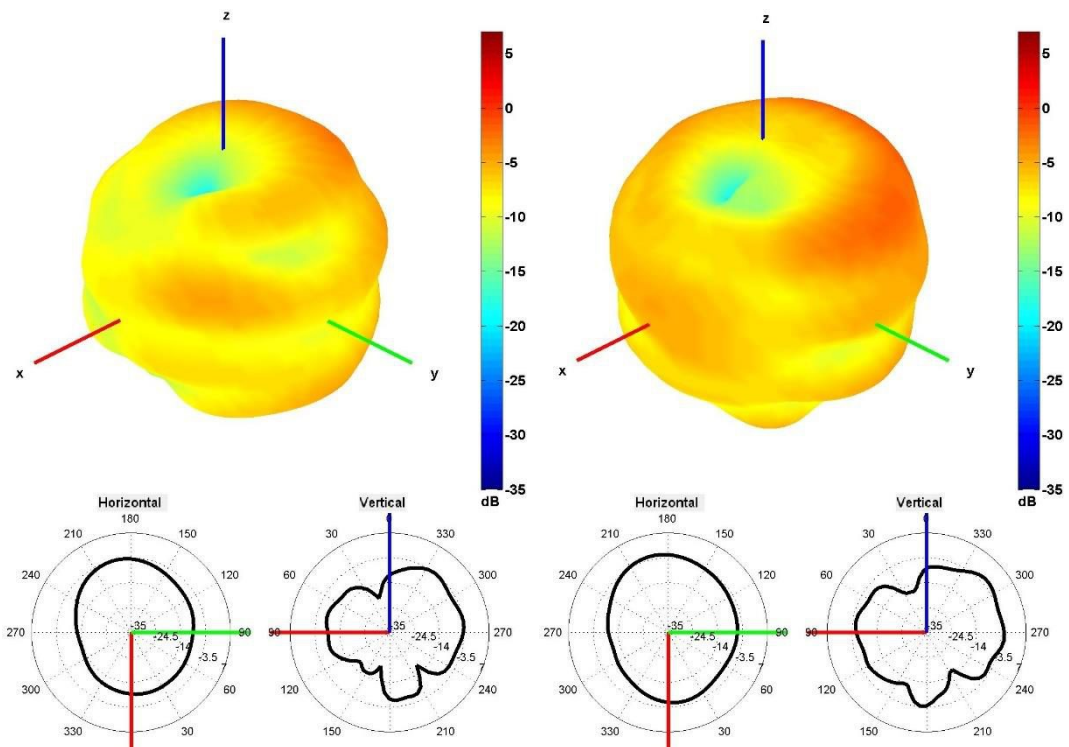
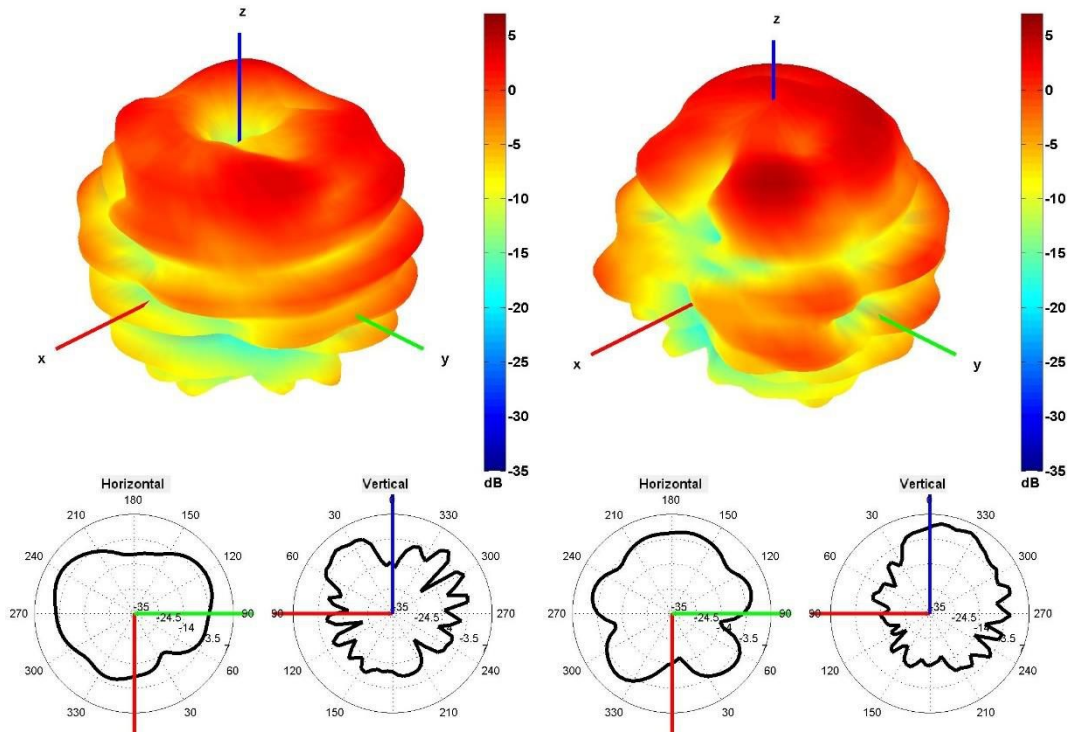

Table 4: 5GNR

4500 and 5500 MHz Radiation pattern



750 and 2500 MHz Radiation pattern



4500 and 5500 MHz Radiation pattern

4. Antenna drawings

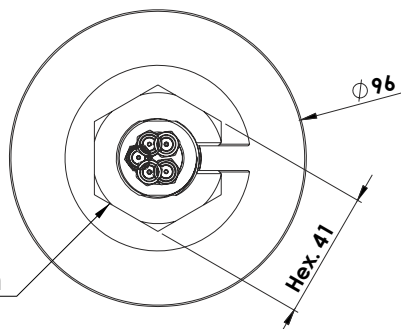
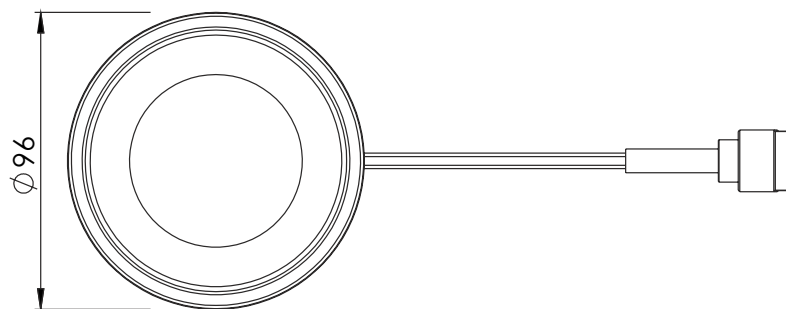
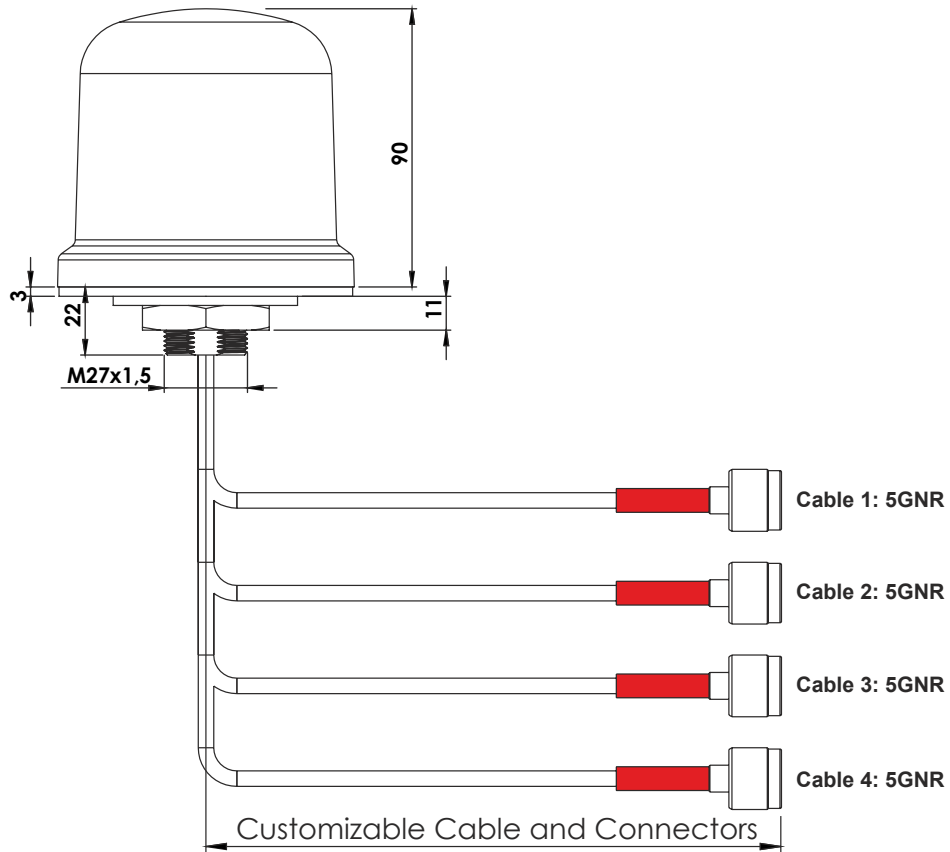

Mounting hole

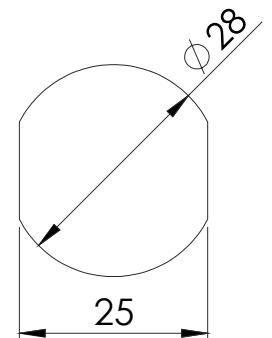

Note: Dimensions are in millimeters
*Dimensions are after mounting
**Max. Torque= 6 Nm

5. Antenna Images

