



Sample Kit

ERU Chokes

ERU 33, PTH flat wire high current inductors – B82559A*A033



www.tdk-electronics.tdk.com



ERU Chokes – ERU 33, PTH flat wire high current inductors – B82559A*A033

L_R	μH	3.2	3.5	4.7	6.0	6.8	10.0
I_{sat} 25 °C	A	95.0	87.0	81.0	62.0	56.0	36.0
I_{sat} 100 °C	A	83.0	77.0	71.0	55.0	47.0	32.0
I_R	A	58.0	57.5	45.5	50.0	47.5	46.0
R_{DC,typ}	mΩ	0.85	0.85	1.20	1.20	1.20	1.20
Pin thickness	mm	1.50 ± 0.20 mm	1.50 ± 0.20 mm	1.25 ± 0.20 mm	1.25 ± 0.20 mm	1.25 ± 0.20 mm	1.25 ± 0.20 mm
Ordering code	B82559*	A4322A033	A4352A033	A5472A033	A5602A033	A5682A033	A5103A033

Construction:

- Size: 33 mm x 33 mm
- Height max: 15.4 mm
- Operating temperature: -40 ... +150 °C
- Packaging: Tray

Features:

- High rated current
- Low DC resistance
- RoHS-compatible
- Easily customized
- AEC-Q200 qualified

Applications:

Energy storage chokes for

- DC/DC converters
- Buck/Boost choke for 48 V board net converters

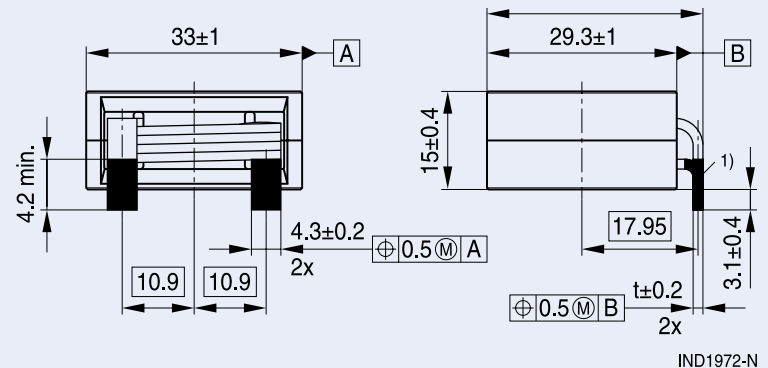

B82559A4322A033 - P300797

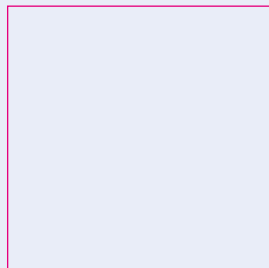
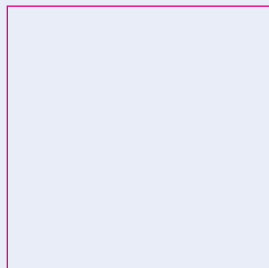

B82559A4352A033 - P100746

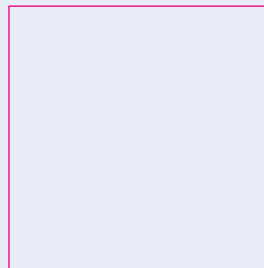

B82559A5472A033 - P302820

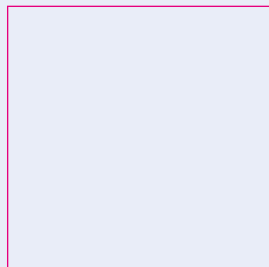
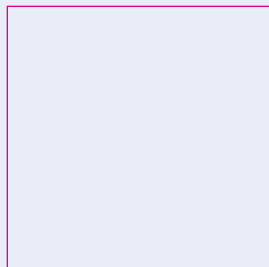

B82559A5602A033 - P100761

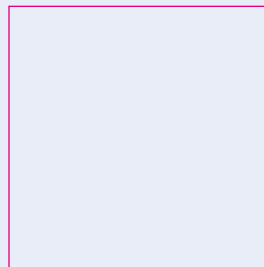

B82559A5682A033 - P100650

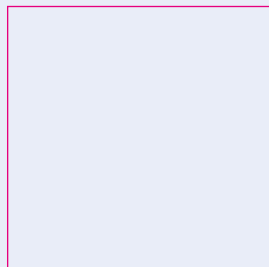
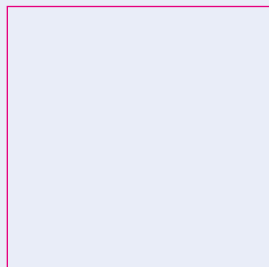

B82559A5103A033 - P100967

