

50Ω Straight PCB Mount, SMP Connector, Plug

**RoHS
Compliant**

Stock No.: 8194254C081

FEATURES

- 50Ω Impedance
- SMP Connector



Product Description

50 OHM SMP PCB mount RF coaxial connectors available as straight or right-angle coaxial plugs. These 50 OHM SMP RF coaxial cable PCB mount RF coax connectors have a mating interface according to MIL-STD-348A (819-4257 'similar' to)

General Specifications

Attribute	Value
Coaxial Connector Type	SMP Connector
Gender	Male
Mounting Type	PCB Mount
Impedance	50Ω
Termination Method	Solder
Body Orientation	Straight
Operating Frequency	0 to 40GHz
Contact Material	Copper Zinc Alloy
Contact Plating	Gold
Mating Type	Snap On

Product Drawing

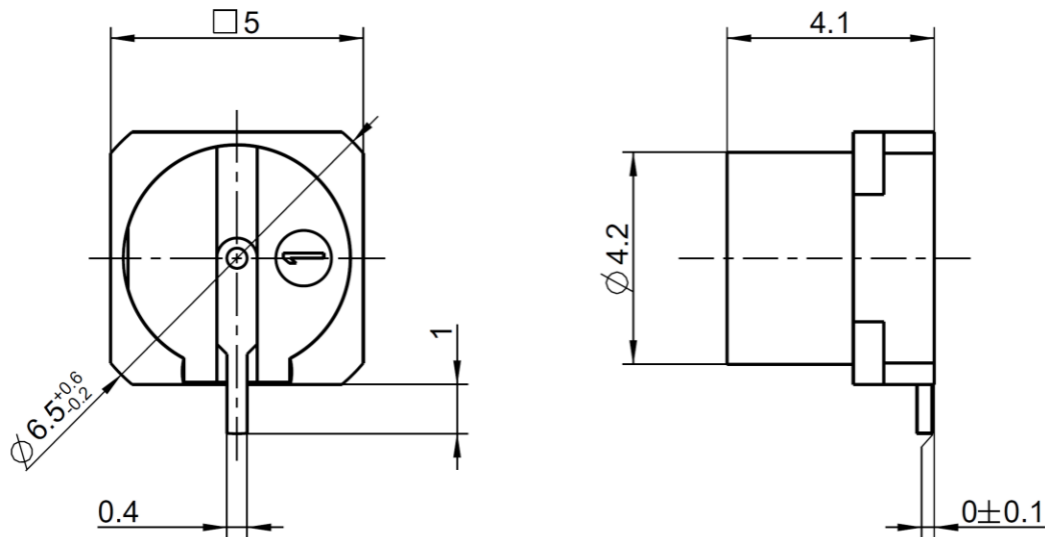

Dimensions: Millimeters (Inches)

Part Number Table

Part Number	Description
8194254C081	50Ω Straight PCB Mount, SMP Connector, Plug

Important Notice: This data sheet and its contents (the "Information") belong to the members of the EASE group of companies (the "Group") or are licensed to it. No license is granted for the use of it other than for information purposes in connection with the products to which it relates. No license of any intellectual property rights is granted. The Information is subject to change without notice and replaces all data sheets previously supplied. The Information supplied is believed to be accurate, but the Group assumes no responsibility for its accuracy or completeness, any error in or omission from it or for any use made of it. Users of this data sheet should check for themselves the Information and the suitability of the products for their purpose and not make any assumptions based on information included or omitted. Liability for loss or damage resulting from any reliance on the Information or use of it (including liability resulting from negligence or where the Group was aware of the possibility of such loss or damage arising) is excluded. This will not operate to limit or restrict the Group's liability for death or personal injury resulting from its negligence. EASE is the registered trademark of Ease Electronics Co., Limited 2019.