

SCHOTTKY BARRIER RECTIFIERS

FEATURES

- Metal silicon junction, majority carrier conduction
- Guarding for overvoltage protection
- Low power loss, high efficiency
- High current capability
- low forward voltage drop
- High surge capability
- For use in low voltage, high frequency inverters, free wheeling, and polarity protection applications

PINNING

PIN	DESCRIPTION
1	Cathode
2	Anode

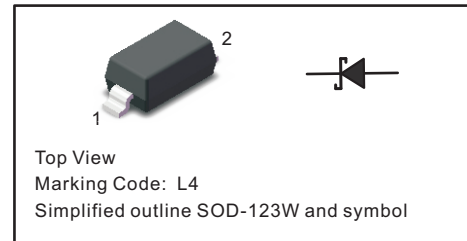

MECHANICAL DATA

- Case: SOD-123W
- Terminals: Solderable per MIL-STD-750, Method 2026
- Approx. Weight: 16mg/0.00056oz

Maximum Ratings and Electrical characteristics

Ratings at 25 °C ambient temperature unless otherwise specified.

Parameter	Symbols	BAT54WA	Units
Peak Repetitive Reverse Voltage	V_{RRM}	30	V
RMS reverse voltage	$V_{R(RMS)}$	21	V
Maximum Average Forward Current at Ta=25°C	I_O	0.2	A
Peak Forward Surge Current, 8.3ms single half sine-wave superimposed on rated load (JEDEC method)	I_{FSM}	0.6	A
Maximum Instantaneous Forward Voltage	V_F	0.32 @ $I_F=0.001A$ 1.0 @ $I_F=0.1A$	V
Maximum DC Reverse Current at Rated DC Blocking Voltage	I_R	2.0 @ $V_R=25V$	uA
Typical Thermal Resistance	$R_{\theta JA}$	610	°C/W
Typical Junction Capacitance at $V_R=0V$, $f=1MHz$	C_j	60	pF
Storage and Operating Junction Temperature Range	T_j, T_{stg}	-55 ~ +125	°C

NOTES:(1)P.C.B. mounted with 5*5mm copper pad areas.

Fig.1 Forward Current Derating Curve

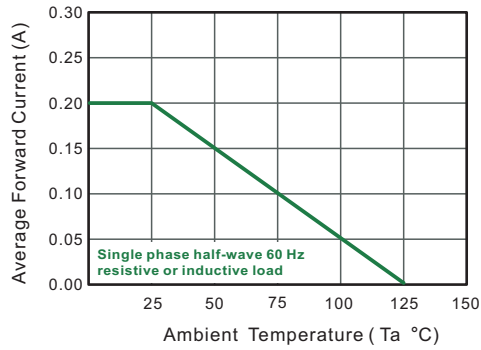

Fig.2 Typical Reverse Characteristics

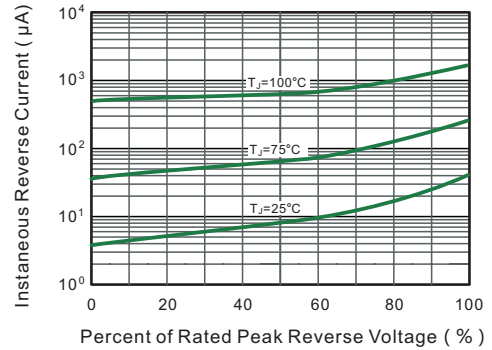

Fig.4 Typical Forward Characteristics

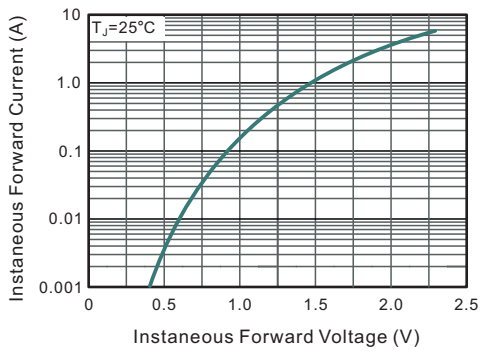

Fig.4 Typical Junction Capacitance

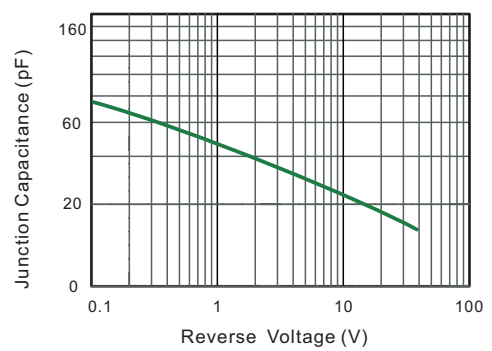
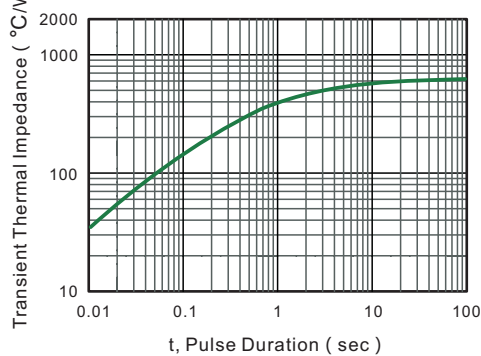

Fig.5 Typical Transient Thermal Impedance



PACKAGE OUTLINE

Plastic surface mounted package; 2 leads

SOD-123W

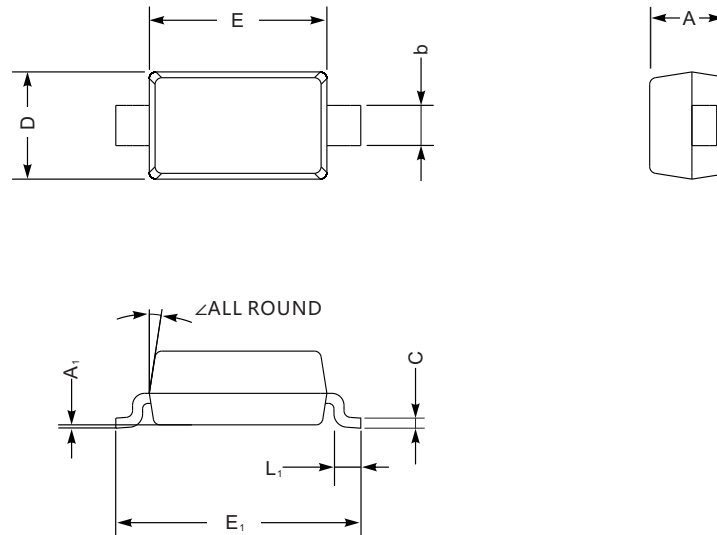

SOD-123W mechanical data

UNIT		A	C	D	E	E ₁	L ₁	b	A ₁	∠
mm	max	1.3	0.22	1.8	2.8	3.9	0.45	0.7	0.2	9°
	min	0.9	0.09	1.5	2.5	3.6	0.25	0.5	—	
mil	max	51	8.7	71	110	154	18	28	8	
	min	35	3.5	59	98	142	10	20	—	

The recommended mounting pad size

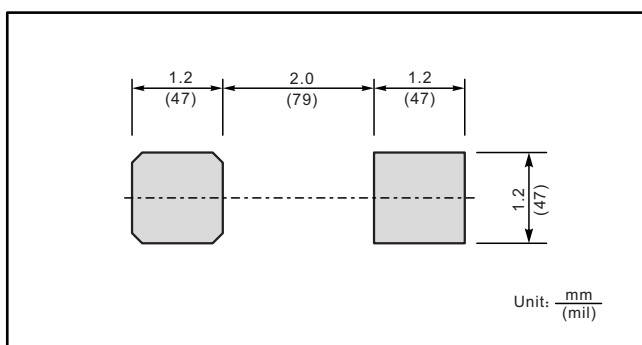

Marking

Type number	Marking code
BAT54WA	L4