



SPECIFICATION SHEET

| | |
|--------------------------------|--|
| SPECIFICATION SHEET NO. | Q0801-SMBP6SMB56CASC |
| DATE | Aug. 01, 2023 |
| REVISION | A0 |
| DESCRIPTION | <p>SMD Transient Voltage Suppressor (TVs) Diodes, SMB/DO-214AA series, P6SMB56CA Type, 2 Pads, Bidirectional</p> <p>Reverse Stand-off Voltage (V R) 47.8V</p> <p>Peak Pulse Power: 600 Watts.</p> <p>Operating Temp. Range -65°C ~+150°C</p> <p>Package in Tape/Reel, 3000pcs/13"Reel</p> <p>RoHS/RoHS III compliant</p> |
| CUSTOMER | |
| CUSTOMER PART NUMBER | |
| CROSS REF. PART NUMBER | |
| ORIGINAL PART NUMBER | MDD P6SMB56CA |
| PART CODE | SMBP6SMB56CASC |

| | | |
|-------------------------|---|--|
| VENDOR APPROVE | | |
| Issued/Checked/Approved |  |  |
| |  | |
| DATE: Aug. 01, 2023 | | |

| | |
|-------------------------|--|
| CUSTOMER APPROVE | |
| | |
| DATE: | |

SMD TRANSIENT VOLTAGE SUPPRESSORS DIODES SMB SERIES



MAIN FEATURE

- The Plastic Package Carries Underwriters Laboratory Flammability Classification 94V-0
- Low Profile Package
- Glass Passivated Junction
- Low Inductance
- 6.8V - 550V Standoff Voltages Average Value
- Excellent Clamping Capability
- 600W Peak Pulse Power Capability At 10/1000µs Waveform
- Fast Response Time
- Repetition Rate (Duty Cycle): 0.01%
- Typical IR Less Than 1µa Above 12V
- High Temperature Soldering
- Built-in Strain Relief

APPLICATION

- I/O Interface
- AC/DC Power Supply
- Low Frequency Signal Transmission Line (RS232, RS485, etc.)

RFQ

[Request For Quotation](#)

PART CODE GUIDE

| SMB | P6SMB56CA | SC |
|-----|-----------|----|
| 1 | 2 | 3 |

- 1) **SMB**: SMD Transient Voltage Suppressor (TVs) Diodes, SMB /DO-214AA series,
- 2) **P6SMB56CA**: Type code for original part number P6SMB56CA
- 3) **SC**: Internal Control Code, (A~Z or 1~9 or Blank) or custom parametric data code.

SMD TRANSIENT VOLTAGE SUPPRESSORS DIODES SMB SERIES

DIMENSION (Unit: Inch/mm)

Image for reference



Marking: standard

* See Marking Code List

SMB/DO-214AA

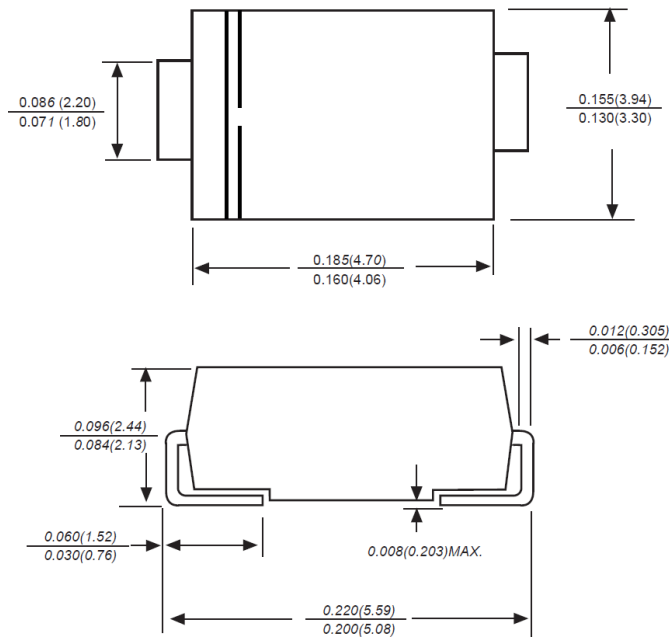

Recommend Pad Layout



| Symbol | Unit (inch) | Unit (mm) |
|--------|-------------|-----------|
| A | 0.110 | 2.80 |
| B | 0.094 | 2.40 |
| C | 0.181 | 4.60 |
| D | 0.086 | 2.20 |
| E | 0.276 | 7.00 |

SMD TRANSIENT VOLTAGE SUPPRESSORS DIODES SMB SERIES

MECHANICAL DATA

| Case | Terminals | Polarity | Mounting Position | Marking | Weight per piece |
|---|--|---|-------------------|--------------------------|-----------------------------|
| JEDEC SMB/DO-214AA molded plastic body over glass passivated junction | Matte Tin-plated leads, Solderable per JESD22-B102D | Color band denotes cathode except Bidirectional. | Any | See Marking Code List | 0.003 ounce, 0.095 grams |

MAX. RATING & CHARACTERISTICS - Ratings at 25°C Ambient Temperature Unless Otherwise Specified.

| Parameter | SYMBOLS | VALUE | UNITS | |
|---|------------|--------------------------------|-------|------|
| Peak Pulse Power Dissipation on TA=25°C by 10x1000µs waveform (Note 1,2, Fig 1) | P ppm | 600 | W | |
| Peak Forward Surge Current 8.3ms Single Half Sine Wave (Note 3) | I FSM | 100 | A | |
| Power Dissipation on infinite heat sink at T A=50°C | P M(AV) | 5.0 | W | |
| Maximum Instantaneous Forward Voltage at 50A for Unidirectional only | V F | 3.5/5.0 | V | |
| Peak Pulse Current on 10/1000 us waveform (Note 1) | I PPM | <i>See Table 1~Table 6</i> | W | |
| Typical Thermal Resistance Junction (Note 2) | to Ambient | R θJA | 100 | °C/W |
| | to Lead | R θJL | 20 | °C/W |
| Operating junction temperature range | T J | -65 ~ +150 | °C | |
| Storage temperature range | T stg | -65 ~ +150 | °C | |

Notes

1. Non-repetitive current pulse, per Fig 3 and derated above T A=25 °C per Fig 2
2. Mounted on 5.0*5.0mm (0.2 x 0.2") copper pads to each terminal
3. VF<3.5V for devices of VBR<200V and VF<5.0V for devices of VBR>201V

SMD TRANSIENT VOLTAGE SUPPRESSORS DIODES SMB SERIES

UNIDIRECTIONAL TYPE- ELECTRICAL CHARACTERISTICS - Ta = 25°C

Table 1

| Part Code | Reverse Stand-off Voltage | Breakdown Voltage | | Test Current | Reverse Leakage Max. | Max. Clamp Voltage | Peak Pulse Current | Marking Code |
|----------------|---------------------------|-------------------|------|--------------|----------------------|--------------------|--------------------|--------------|
| | | V BR @ I T | | | | | | |
| | V RMV | Min | Max | I T | I R @ V RWM | V C @ I PPM | I PPM | |
| | V | V | V | mA | µA | V | A | |
| SMBP6SMB6V8ASA | 5.8 | 6.45 | 7.14 | 10 | 1000 | 10.5 | 58.1 | 6V8A |
| SMBP6SMB7V5ASA | 6.4 | 7.13 | 7.88 | 10 | 500 | 11.3 | 54 | 7V5A |
| SMBP6SMB8V2ASA | 7.02 | 7.79 | 8.61 | 10 | 200 | 12.1 | 50.4 | 8V2A |
| SMBP6SMB9V1ASA | 7.78 | 8.65 | 9.55 | 1 | 50 | 13.4 | 45.5 | 9V1A |
| SMBP6SMB10AS0A | 8.55 | 9.5 | 10.5 | 1 | 10 | 14.5 | 42.1 | 10A |
| SMBP6SMB11AS0A | 9.4 | 10.5 | 11.6 | 1 | 5 | 15.6 | 39.1 | 11A |
| SMBP6SMB12AS0A | 10.2 | 11.4 | 12.6 | 1 | 5 | 16.7 | 36.5 | 12A |
| SMBP6SMB13AS0A | 11.1 | 12.4 | 13.7 | 1 | 1 | 18.2 | 33.5 | 13A |
| SMBP6SMB15AS0A | 12.8 | 14.3 | 15.8 | 1 | 1 | 21.2 | 28.8 | 15A |
| SMBP6SMB16AS0A | 13.6 | 15.2 | 16.8 | 1 | 1 | 22.5 | 27.1 | 16A |
| SMBP6SMB18AS0A | 15.3 | 17.1 | 18.9 | 1 | 1 | 25.5 | 24.2 | 18A |
| SMBP6SMB20AS0A | 17.1 | 19 | 21 | 1 | 1 | 27.7 | 22 | 20A |
| SMBP6SMB22AS0A | 18.8 | 20.9 | 23.1 | 1 | 1 | 30.6 | 19.9 | 22A |
| SMBP6SMB24AS0A | 20.5 | 22.8 | 25.2 | 1 | 1 | 33.2 | 18.4 | 24A |
| SMBP6SMB27AS0A | 23.1 | 25.7 | 28.4 | 1 | 1 | 37.5 | 16.3 | 27A |
| SMBP6SMB30AS0A | 25.6 | 28.5 | 31.5 | 1 | 1 | 41.4 | 14.7 | 30A |
| SMBP6SMB33AS0A | 28.2 | 31.4 | 34.7 | 1 | 1 | 45.7 | 13.3 | 33A |
| SMBP6SMB36AS0A | 30.8 | 34.2 | 37.8 | 1 | 1 | 49.9 | 12.2 | 36A |
| SMBP6SMB39AS0A | 33.3 | 37.1 | 41 | 1 | 1 | 53.9 | 11.3 | 39A |

SMD TRANSIENT VOLTAGE SUPPRESSORS DIODES SMB SERIES

UNIDIRECTIONAL TYPE- ELECTRICAL CHARACTERISTICS - Ta = 25°C

Table 2

| Part Code | Reverse Stand-off Voltage | Breakdown Voltage | | Test Current | Reverse Leakage Max. | Max. Clamp Voltage | Peak Pulse Current | Marking Code |
|----------------|---------------------------|-------------------|------|--------------|----------------------|--------------------|--------------------|--------------|
| | | V BR @ I T | | | | | | |
| | V RMV | Min | Max | I T | I R @ V RWM | V C @ I PPM | I PPM | |
| | V | V | V | mA | µA | V | A | |
| SMBP6SMB43AS0A | 36.8 | 40.9 | 45.2 | 1 | 1 | 59.3 | 10.3 | 43A |
| SMBP6SMB47AS0A | 40.2 | 44.7 | 49.4 | 1 | 1 | 64.8 | 9.4 | 47A |
| SMBP6SMB51AS0A | 43.6 | 48.5 | 53.6 | 1 | 1 | 70.1 | 8.7 | 51A |
| SMBP6SMB56AS0A | 47.8 | 53.2 | 58.8 | 1 | 1 | 77 | 7.9 | 56A |
| SMBP6SMB62AS0A | 53 | 58.9 | 65.1 | 1 | 1 | 85 | 7.2 | 62A |
| SMBP6SMB68AS0A | 58.1 | 64.6 | 71.4 | 1 | 1 | 92 | 6.6 | 68A |
| SMBP6SMB75AS0A | 64.1 | 71.3 | 78.8 | 1 | 1 | 103 | 5.9 | 75A |
| SMBP6SMB82AS0A | 70.1 | 77.9 | 86.1 | 1 | 1 | 113 | 5.4 | 82A |
| SMBP6SMB91AS0A | 77.8 | 86.5 | 95.5 | 1 | 1 | 125 | 4.9 | 91A |
| SMBP6SMB100ASA | 85.5 | 95 | 105 | 1 | 1 | 137 | 4.5 | 100A |
| SMBP6SMB110ASA | 94 | 105 | 116 | 1 | 1 | 152 | 4 | 110A |
| SMBP6SMB120ASA | 102 | 114 | 126 | 1 | 1 | 165 | 3.7 | 120A |
| SMBP6SMB130ASA | 111 | 124 | 137 | 1 | 1 | 179 | 3.4 | 130A |
| SMBP6SMB150ASA | 128 | 143 | 158 | 1 | 1 | 207 | 2.9 | 150A |
| SMBP6SMB160ASA | 136 | 152 | 168 | 1 | 1 | 219 | 2.8 | 160A |
| SMBP6SMB170ASA | 145 | 162 | 179 | 1 | 1 | 234 | 2.6 | 170A |
| SMBP6SMB180ASA | 154 | 171 | 189 | 1 | 1 | 246 | 2.5 | 180A |
| SMBP6SMB200ASA | 171 | 190 | 210 | 1 | 1 | 274 | 2.2 | 200A |
| SMBP6SMB220ASA | 185 | 209 | 231 | 1 | 1 | 328 | 1.9 | 220A |

SMD TRANSIENT VOLTAGE SUPPRESSORS DIODES SMB SERIES

UNIDIRECTIONAL TYPE- ELECTRICAL CHARACTERISTICS - Ta = 25°C

Table 3

| Part Code | Reverse Stand-off Voltage | Breakdown Voltage | | Test Current | Reverse Leakage Max. | Max. Clamp Voltage | Peak Pulse Current | Marking Code |
|----------------|---------------------------|-------------------|-------|--------------|----------------------|--------------------|--------------------|--------------|
| | | V BR @ I T | | | | | | |
| | V RMV | Min | Max | I T | I R @ V RWM | V C @ I PPM | I PPM | |
| | V | V | V | mA | µA | V | A | |
| SMBP6SMB250ASA | 214 | 237 | 263 | 1 | 1 | 344 | 1.8 | 250A |
| SMBP6SMB300ASA | 256 | 285 | 315 | 1 | 1 | 414 | 1.5 | 300A |
| SMBP6SMB350ASA | 300 | 332 | 368 | 1 | 1 | 482 | 1.3 | 350A |
| SMBP6SMB400ASA | 342 | 380 | 420 | 1 | 1 | 548 | 1.1 | 400A |
| SMBP6SMB440ASA | 376 | 418 | 462 | 1 | 1 | 602 | 1 | 440A |
| SMBP6SMB480ASA | 408 | 456 | 504 | 1 | 1 | 658 | 0.9 | 480A |
| SMBP6SMB510ASA | 434 | 485 | 535 | 1 | 1 | 698 | 0.9 | 510A |
| SMBP6SMB530ASA | 477 | 503.5 | 556.5 | 1 | 1 | 725 | 0.8 | 530A |
| SMBP6SMB540ASA | 486 | 513 | 567 | 1 | 1 | 740 | 0.8 | 540A |
| SMBP6SMB550ASA | 495 | 522.5 | 577.5 | 1 | 1 | 760 | 0.8 | 550A |

SMD TRANSIENT VOLTAGE SUPPRESSORS DIODES SMB SERIES

BIDIRECTIONAL TYPE- ELECTRICAL CHARACTERISTICS - Ta = 25°C

Table 4

| Part Code | Reverse Stand-off Voltage | Breakdown Voltage | | Test Current | Reverse Leakage Max. | Max. Clamp Voltage | Peak Pulse Current | Marking Code |
|----------------|---------------------------|-------------------|------|--------------|----------------------|--------------------|--------------------|--------------|
| | | V BR @ I T | | | | | | |
| | V RMV | Min | Max | I T | I R @ V RWM | V C @ I PPM | I PPM | |
| | V | V | V | mA | µA | V | A | |
| SMBP6SMB6V8CAC | 5.8V | 6.45 | 7.14 | 10 | 1000 | 10.5 | 58.1 | 6V8C |
| SMBP6SMB7V5CAC | 6.4 | 7.13 | 7.88 | 10 | 500 | 11.3 | 54 | 7V5C |
| SMBP6SMB8V2CAC | 7.02 | 7.79 | 8.61 | 10 | 200 | 12.1 | 50.4 | 8V2C |
| SMBP6SMB9V1CAC | 7.78 | 8.65 | 9.55 | 1 | 50 | 13.4 | 45.5 | 9V1C |
| SMBP6SMB10CASC | 8.55 | 9.5 | 10.5 | 1 | 10 | 14.5 | 42.1 | 10C |
| SMBP6SMB11CASC | 9.4 | 10.5 | 11.6 | 1 | 5 | 15.6 | 39.1 | 11C |
| SMBP6SMB12CASC | 10.2 | 11.4 | 12.6 | 1 | 5 | 16.7 | 36.5 | 12C |
| SMBP6SMB13CASC | 11.1 | 12.4 | 13.7 | 1 | 1 | 18.2 | 33.5 | 13C |
| SMBP6SMB15CASC | 12.8 | 14.3 | 15.8 | 1 | 1 | 21.2 | 28.8 | 15C |
| SMBP6SMB16CASC | 13.6 | 15.2 | 16.8 | 1 | 1 | 22.5 | 27.1 | 16C |
| SMBP6SMB18CASC | 15.3 | 17.1 | 18.9 | 1 | 1 | 25.5 | 24.2 | 18C |
| SMBP6SMB20CASC | 17.1 | 19 | 21 | 1 | 1 | 27.7 | 22 | 20C |
| SMBP6SMB22CASC | 18.8 | 20.9 | 23.1 | 1 | 1 | 30.6 | 19.9 | 22C |
| SMBP6SMB24CASC | 20.5 | 22.8 | 25.2 | 1 | 1 | 33.2 | 18.4 | 24C |
| SMBP6SMB27CASC | 23.1 | 25.7 | 28.4 | 1 | 1 | 37.5 | 16.3 | 27C |
| SMBP6SMB30CASC | 25.6 | 28.5 | 31.5 | 1 | 1 | 41.4 | 14.7 | 30C |
| SMBP6SMB33CASC | 28.2 | 31.4 | 34.7 | 1 | 1 | 45.7 | 13.3 | 33C |
| SMBP6SMB36CASC | 30.8 | 34.2 | 37.8 | 1 | 1 | 49.9 | 12.2 | 36C |
| SMBP6SMB39CASC | 33.3 | 37.1 | 41 | 1 | 1 | 53.9 | 11.3 | 39C |

SMD TRANSIENT VOLTAGE SUPPRESSORS DIODES SMB SERIES

BIDIRECTIONAL TYPE- ELECTRICAL CHARACTERISTICS - Ta = 25°C

Table 5

| Part Code | Reverse Stand-off Voltage | Breakdown Voltage | | Test Current | Reverse Leakage Max. | Max. Clamp Voltage | Peak Pulse Current | Marking Code |
|-----------------------|---------------------------|-------------------|-------------|--------------|----------------------|--------------------|--------------------|--------------|
| | | V BR @ I T | | | | | | |
| | V RMV | Min | Max | I T | I R @ V RWM | V C @ I PPM | I PPM | |
| | V | V | V | mA | µA | V | A | |
| SMBP6SMB43CASC | 36.8 | 40.9 | 45.2 | 1 | 1 | 59.3 | 10.3 | 43C |
| SMBP6SMB47CASC | 40.2 | 44.7 | 49.4 | 1 | 1 | 64.8 | 9.4 | 47C |
| SMBP6SMB51CASC | 43.6 | 48.5 | 53.6 | 1 | 1 | 70.1 | 8.7 | 51C |
| SMBP6SMB56CASC | 47.8 | 53.2 | 58.8 | 1 | 1 | 77 | 7.9 | 56C |
| SMBP6SMB62CASC | 53 | 58.9 | 65.1 | 1 | 1 | 85 | 7.2 | 62C |
| SMBP6SMB68CASC | 58.1 | 64.6 | 71.4 | 1 | 1 | 92 | 6.6 | 68C |
| SMBP6SMB75CASC | 64.1 | 71.3 | 78.8 | 1 | 1 | 103 | 5.9 | 75C |
| SMBP6SMB82CASC | 70.1 | 77.9 | 86.1 | 1 | 1 | 113 | 5.4 | 82C |
| SMBP6SMB91CASC | 77.8 | 86.5 | 95.5 | 1 | 1 | 125 | 4.9 | 91C |
| SMBP6SMB100CAC | 85.5 | 95 | 105 | 1 | 1 | 137 | 4.5 | 100C |
| SMBP6SMB110CAC | 94 | 105 | 116 | 1 | 1 | 152 | 4 | 110C |
| SMBP6SMB120CAC | 102 | 114 | 126 | 1 | 1 | 165 | 3.7 | 120C |
| SMBP6SMB130CAC | 111 | 124 | 137 | 1 | 1 | 179 | 3.4 | 130C |
| SMBP6SMB150CAC | 128 | 143 | 158 | 1 | 1 | 207 | 2.9 | 150C |
| SMBP6SMB160CAC | 136 | 152 | 168 | 1 | 1 | 219 | 2.8 | 160C |
| SMBP6SMB170CAC | 145 | 162 | 179 | 1 | 1 | 234 | 2.6 | 170C |
| SMBP6SMB180CAC | 154 | 171 | 189 | 1 | 1 | 246 | 2.5 | 180C |
| SMBP6SMB200CAC | 171 | 190 | 210 | 1 | 1 | 274 | 2.2 | 200C |
| SMBP6SMB220CAC | 185 | 209 | 231 | 1 | 1 | 328 | 1.9 | 220C |

SMD TRANSIENT VOLTAGE SUPPRESSORS DIODES SMB SERIES

BIDIRECTIONAL TYPE- ELECTRICAL CHARACTERISTICS - Ta = 25°C

Table 6

| Part Code | Reverse Stand-off Voltage | Breakdown Voltage | | Test Current | Reverse Leakage Max. | Max. Clamp Voltage | Peak Pulse Current | Marking Code |
|----------------|---------------------------|-------------------|-------|--------------|----------------------|--------------------|--------------------|--------------|
| | | V BR @ I T | | | | | | |
| | V RMV | Min | Max | I T | I R @ V RWM | V C @ I PPM | I PPM | |
| | V | V | V | mA | µA | V | A | |
| SMBP6SMB250CAC | 214 | 237 | 263 | 1 | 1 | 344 | 1.8 | 250C |
| SMBP6SMB300CAC | 256 | 285 | 315 | 1 | 1 | 414 | 1.5 | 300C |
| SMBP6SMB350CAC | 300 | 332 | 368 | 1 | 1 | 482 | 1.3 | 350C |
| SMBP6SMB400CAC | 342 | 380 | 420 | 1 | 1 | 548 | 1.1 | 400C |
| SMBP6SMB440CAC | 376 | 418 | 462 | 1 | 1 | 602 | 1 | 440C |
| SMBP6SMB480CAC | 408 | 456 | 504 | 1 | 1 | 658 | 0.9 | 480C |
| SMBP6SMB510CAC | 434 | 485 | 535 | 1 | 1 | 698 | 0.9 | 510C |
| SMBP6SMB530CAC | 477 | 503.5 | 556.5 | 1 | 1 | 725 | 0.8 | 530C |
| SMBP6SMB540CAC | 486 | 513 | 567 | 1 | 1 | 740 | 0.8 | 540C |
| SMBP6SMB550CAC | 495 | 522.5 | 577.5 | 1 | 1 | 760 | 0.8 | 550C |

SMD TRANSIENT VOLTAGE SUPPRESSORS DIODES SMB SERIES
RELIABILITY

| Number | Experiment Items | Experiment Method And Conditions | Reference Documents |
|--------|------------------------------------|--|---------------------------------|
| 1 | Solder Resistance Test | Test 260°C± 5°C for 10 ± 2 sec. Immerse body into solder 1/16" ± 1/32" | MIL-STD-750D METHOD-2031.2 |
| 2 | Solderability Test | 230°C ±5°C for 5 sec. | MIL-STD-750D METHOD-2026.1 0 |
| 3 | Pull Test | 1 kg in axial lead direction for 10 sec. | MIL-STD-750D METHOD-2036.4 |
| 4 | Bend Test | 0.5Kg Weight Applied To Each Lead, Bending Arcs 90 °C ± 5 °C For 3 Times | MIL-STD-750D METHOD-2036.4 |
| 5 | High Temperature Reverse Bias Test | TA=100°C for 1000 Hours at VR=80% Rated VR | MIL-STD-750D METHOD-1038.4 |
| 6 | Forward Operation Life Test | TA=25°C Rated Average Rectified Current | MIL-STD-750D METHOD-1027.3 |
| 7 | Intermittent Operation Life Test | On state: 5 min with rated IRMS Power Off state: 5 min with Cool Forced Air. On and off for 1000 cycles. | MIL-STD-750D METHOD-1036.3 |
| 8 | Pressure Cooker Test | 15 PSIG, TA=121°C, 4 hours | MIL-S-19500 APPENOIXC |
| 9 | Temperature Cycling Test | -55°C~+125°C; 30 Minutes For Dwelled Time 5 minutes for transferred time. Total: 10 cycles. | MIL-STD-750D METHOD-1051.7 |
| 10 | Thermal Shock Test | 0°C for 5 minutes., 100°C for 5minutes, Total: 10 cycles | MIL-STD-750D METHOD-1056.7 |
| 11 | Forward Surge Test | 8.3ms Single Sale Sine-wave One Surge. | MIL-STD-750D METHOD-4066.4 |
| 12 | Humidity Test | TA=65°C, RH=98% for 1000 hours. | MIL-STD-750D METHOD-1021.3 |
| 13 | High Temperature Storage life Test | 150°C for 1000 Hours | MIL-STD-750D METHOD-1031.5 |

SMD TRANSIENT VOLTAGE SUPPRESSORS DIODES SMB SERIES

SUGGESTED REFLOW PROFILE (For Reference Only)



| | | |
|--|----------------------------------|-------------------|
| Profile Feature | | Pb-Free Assembly |
| Average Ramp-up Rate (Ts Max to Tp) | | 3°C/second Max |
| Preheat | Temperature Min (Ts Min.) | 150°C |
| | Temperature Max (Ts Max.) | 200°C |
| | Time (ts Min. to ts Max.) | 60 ~ 180 seconds |
| Time maintained above | Temperature (Tl) | 217°C |
| | Time (tl) | 60 ~ 150 seconds |
| Peak/Classification Temperature (Tp) | | 260 °C |
| Time within 5°C of actual Peak Temperature (tp) | | 20 ~ 40 seconds |
| Ramp-down rate | | 6 °C /Second Max. |
| Time 25 °C to Peak Temperature | | 8 minutes Max. |
| Suggest reflow times | | 3 Times Max. |

SMD TRANSIENT VOLTAGE SUPPRESSORS DIODES SMB SERIES

RATINGS AND CHARACTERISTIC CURVES (For Reference Only) - Ta= 25°C Unless Otherwise Specified

Figure 1. Peak Pulse Power Rating Curve

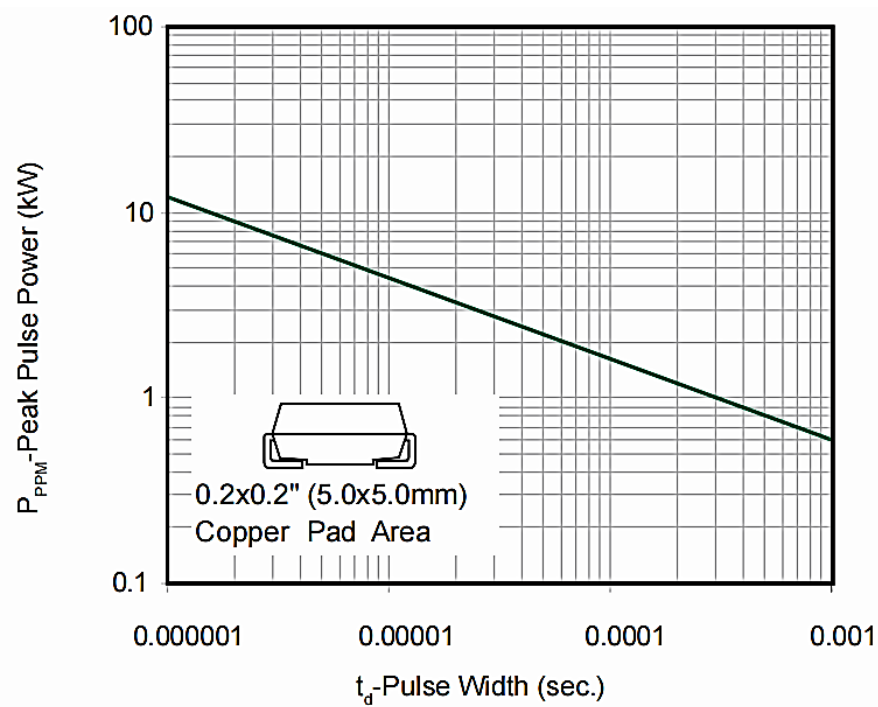
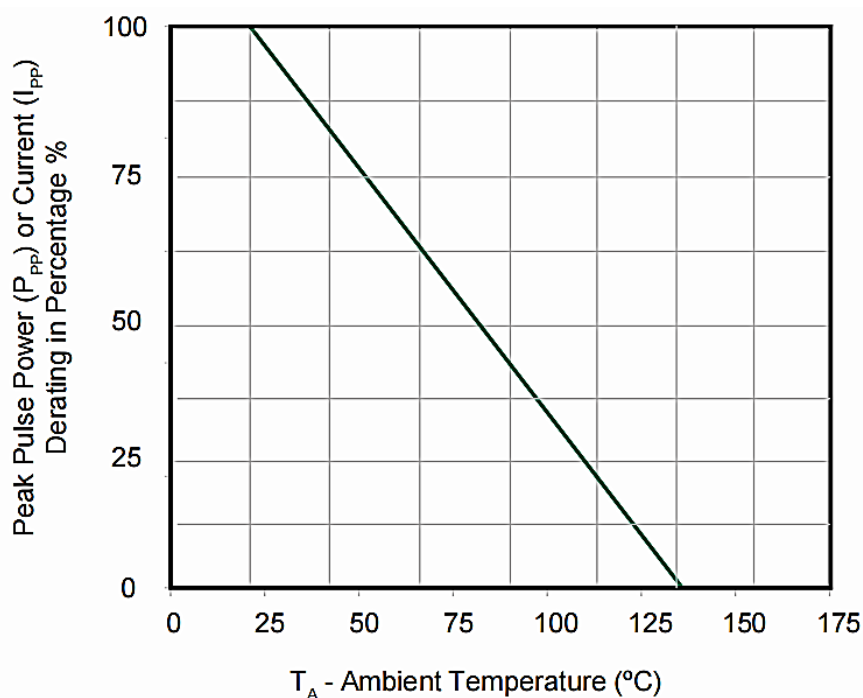

Figure 2. Pulse Derating Curve



SMD TRANSIENT VOLTAGE SUPPRESSORS DIODES SMB SERIES

RATINGS AND CHARACTERISTIC CURVES (For Reference Only) - Ta= 25°C Unless Otherwise Specified

Figure 3. Pulse Waveform

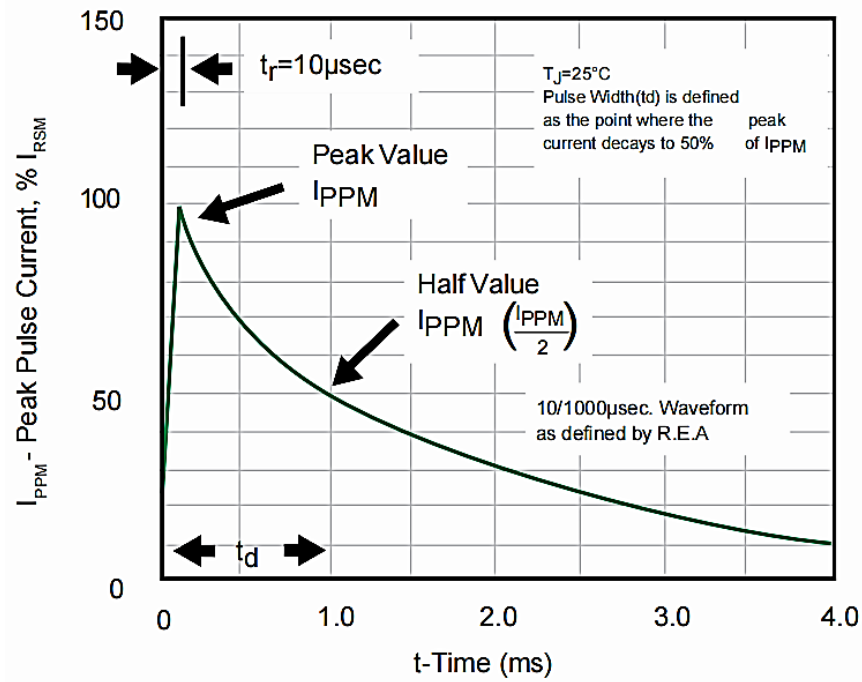
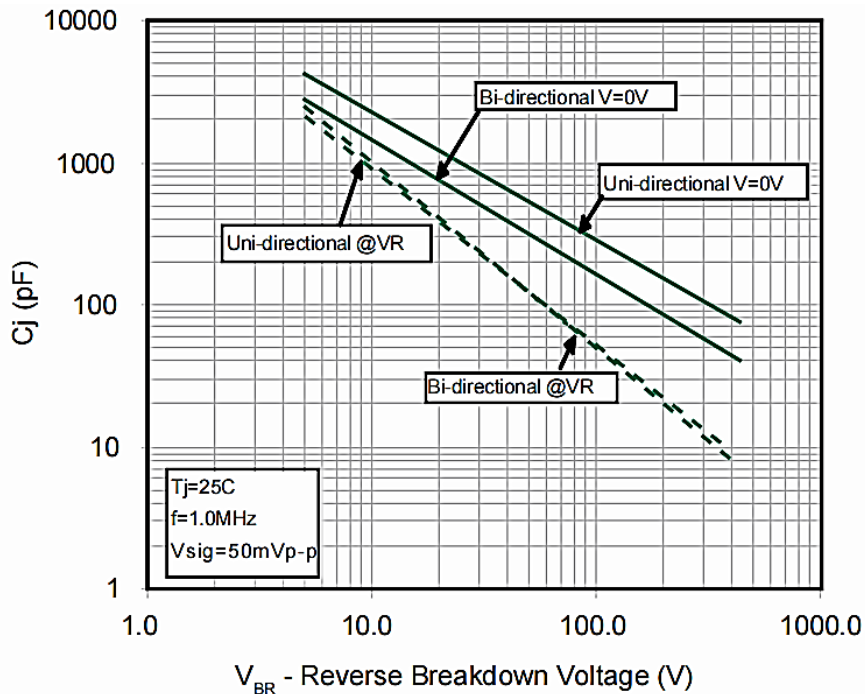

Figure 4. Typical Junction Capacitance



SMD TRANSIENT VOLTAGE SUPPRESSORS DIODES SMB SERIES

RATINGS AND CHARACTERISTIC CURVES (For Reference Only) - Ta= 25°C Unless Otherwise Specified

Figure 5. Steady State Power Dissipation Derating Curve

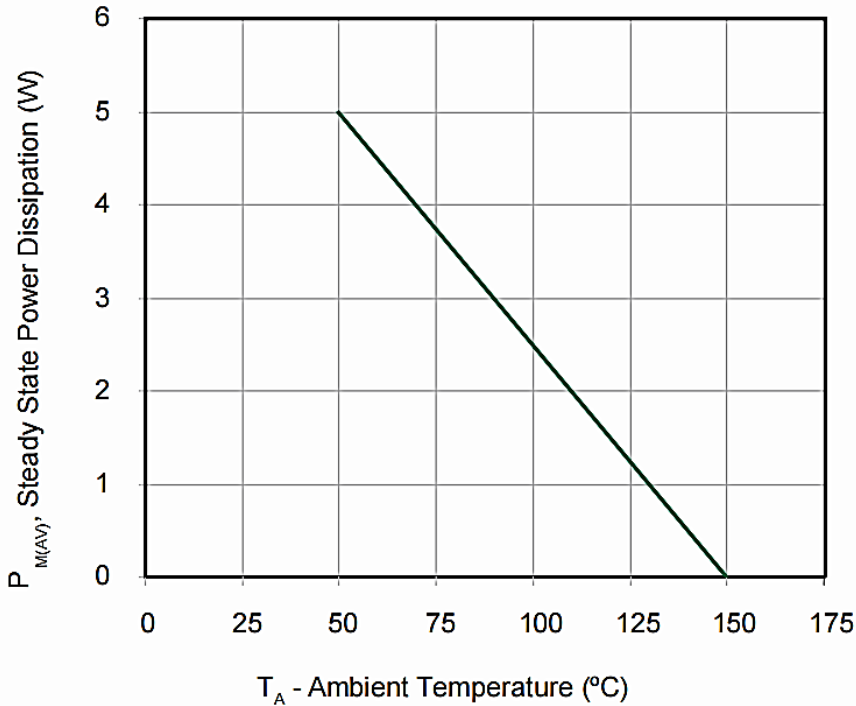
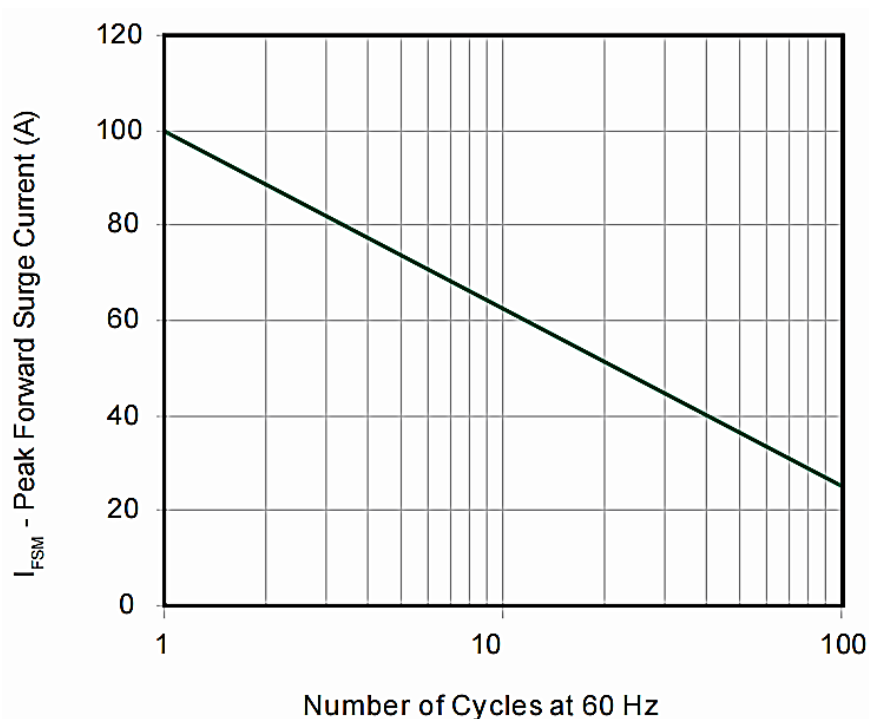

Figure 6. Maximum Non-Repetitive Peak Forward Surge Current Uni-Directional Only



SMD TRANSIENT VOLTAGE SUPPRESSORS DIODES SMB SERIES

TAPE/REEL (Unit: mm)

All Devices are packed in accordance with EIA standard RS-481-A and specifications.

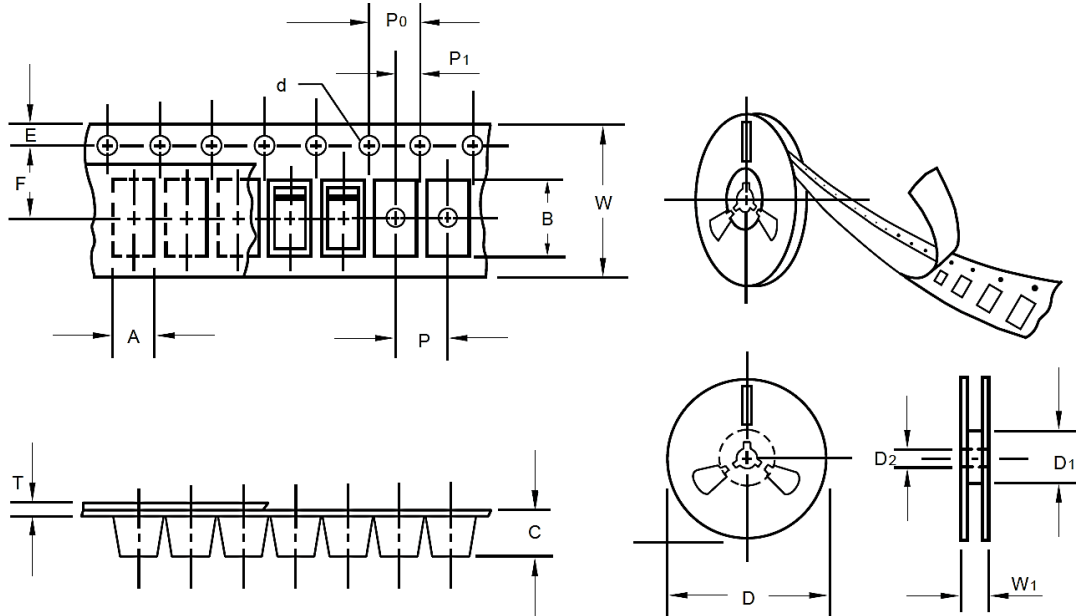

| Item | Symbol | Tolerance | SMB/DO-214AA |
|--------------------------|--------|-----------|--------------|
| Carrier width | A | 0.1 | 3.81 |
| Carrier Length | B | 0.1 | 5.41 |
| Carrier Depth | C | 0.1 | 2.42 |
| Sprocket hole | d | 0.05 | 1.50 |
| 13"Reel outside diameter | D | 2.0 | 330.00 |
| 13"Reel inner diameter | D1 | Min. | 50.00 |
| 7"Reel outside diameter | - | - | - |
| 7"Reel inner diameter | - | - | - |
| Feed hole diameter | D2 | 0.5 | 13.00 |
| Sprocket hole position | E | 0.1 | 1.75 |
| Punch hole position | F | 0.1 | 5.55 |
| Punch hole pitch | P | 0.1 | 8.00 |
| Sprocket hole pitch | P0 | 0.1 | 4.00 |
| Embossment center | P1 | 0.1 | 2.00 |
| Overall tape thickness | T | 0.1 | 0.30 |
| Tape width | W | 0.3 | 12.00 |
| Reel width | W1 | 1.0 | 12.30 |

SMD TRANSIENT VOLTAGE SUPPRESSORS DIODES SMB SERIES

PACKAGE For Reference Only

| Case Code | SMB |
|-----------|----------|
| Reel Size | 13" |
| Reel Size | 330 mm |
| SPQ/Reel | 3000 pcs |
| Qty. /Box | 6000 pcs |
| G.W/Box | / |

GENERAL RETURN/REFUND POLICY

NextGen requires that customers first obtain an RMA (Returned Merchandise Authorization) number prior to returning any products. Returns must be made within 30 days of the date of invoice, be in the original packaging, unused and like-new condition. At the time of quoting or purchasing, a product may say that it is Non-Cancelable/Non-Returnable (NCNR). These products are not returnable and not refundable.

IMPORTANT NOTICE AND DISCLAIMER

- 1) NextGen Component, Inc. reserves the right to make changes to this document and its products and specifications at any time without notice. Customers should obtain and confirm the latest product information and specifications before final design, purchase or use.
- 2) NextGen Component, Inc makes no warranty, representation or guarantee regarding the suitability of its products for any particular purpose, not does NextGen Component, Inc assume any liability for application assistance or customer product design.
- 3) NextGen Component, Inc does not warrant or accept any liability with products which are purchased or used for any unintended or unauthorized application. No license is granted by implication or otherwise under any intellectual property rights of NextGen Component, Inc
- 4) NextGen Component, Inc. products are not authorized for use as critical components in life support devices or systems without express written approval of NextGen Component, Inc.