



**SPECIFICATION SHEET**

|                                |  |
|--------------------------------|--|
| <b>SPECIFICATION SHEET NO.</b> | Q0801-SMBP6SMB36CASC   |
| <b>DATE</b>                    | Aug. 01, 2023  |
| <b>REVISION</b>                | A0   |
| <b>DESCRIPTION</b>             | <p>SMD Transient Voltage Suppressor (TVs) Diodes, SMB/DO-214AA series, P6SMB36CA Type, 2 Pads, Bidirectional</p> <p>Reverse Stand-off Voltage (V<sub>R</sub>) 30.8V</p> <p>Peak Pulse Power: 600 Watts.</p> <p>Operating Temp. Range -65°C ~+150°C</p> <p>Package in Tape/Reel, 3000pcs/13"Reel</p> <p>RoHS/RoHS III compliant</p> |
| <b>CUSTOMER</b>                |  |
| <b>CUSTOMER PART NUMBER</b>    |  |
| <b>CROSS REF. PART NUMBER</b>  |  |
| <b>ORIGINAL PART NUMBER</b>    | MDD P6SMB36CA  |
| <b>PART CODE</b>               | SMBP6SMB36CASC   |

|                         |   |  |
|-------------------------|---|--|
| <b>VENDOR APPROVE</b>   |   |  |
| Issued/Checked/Approved |    |  |
|                         |  |  |
| DATE: Aug. 01, 2023     |   |  |

|                         |  |
|-------------------------|--|
| <b>CUSTOMER APPROVE</b> |  |
|                         |  |
| DATE:                   |  |

**SMD TRANSIENT VOLTAGE SUPPRESSORS DIODES SMB SERIES**



**MAIN FEATURE**

- The Plastic Package Carries Underwriters Laboratory Flammability Classification 94V-0
- Low Profile Package
- Glass Passivated Junction
- Low Inductance
- 6.8V - 550V Standoff Voltages Average Value
- Excellent Clamping Capability
- 600W Peak Pulse Power Capability At 10/1000µs Waveform
- Fast Response Time
- Repetition Rate (Duty Cycle): 0.01%
- Typical IR Less Than 1µa Above 12V
- High Temperature Soldering
- Built-in Strain Relief

**APPLICATION**

- I/O Interface
- AC/DC Power Supply
- Low Frequency Signal Transmission Line (RS232, RS485, etc.)

**RFQ**

[Request For Quotation](#)

**PART CODE GUIDE**

| SMB | P6SMB36CA | SC |
|-----|-----------|----|
| 1   | 2         | 3  |

- 1) **SMB**: SMD Transient Voltage Suppressor (TVs) Diodes, SMB /DO-214AA series,
- 2) **P6SMB36CA**: Type code for original part number P6SMB36CA
- 3) **SC**: Internal Control Code, (A~Z or 1~9 or Blank) or custom parametric data code.

**SMD TRANSIENT VOLTAGE SUPPRESSORS DIODES SMB SERIES**

**DIMENSION (Unit: Inch/mm)**

Image for reference



**Marking:** standard

\* See Marking Code List

SMB/DO-214AA

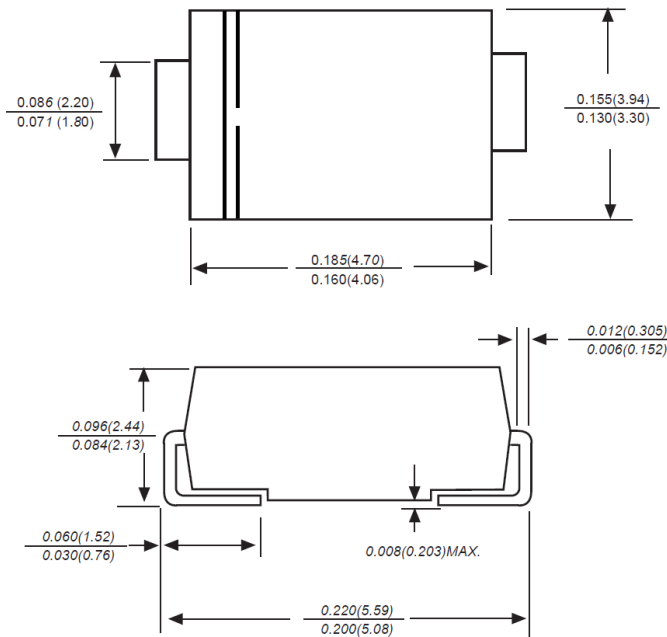

Recommend Pad Layout

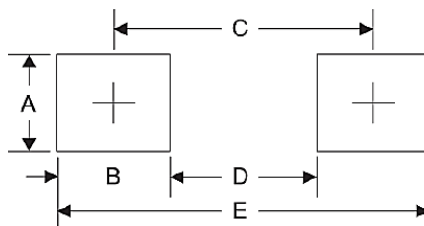

| Symbol | Unit (inch) | Unit (mm) |
|--------|-------------|-----------|
| A      | 0.110       | 2.80      |
| B      | 0.094       | 2.40      |
| C      | 0.181       | 4.60      |
| D      | 0.086       | 2.20      |
| E      | 0.276       | 7.00      |

## SMD TRANSIENT VOLTAGE SUPPRESSORS DIODES SMB SERIES

**MECHANICAL DATA**

| Case  | Terminals   | Polarity   | Mounting Position | Marking               | Weight per piece            |
|---|---|--|-------------------|-----------------------|-----------------------------|
| JEDEC<br>SMB/DO-214AA<br>molded plastic body<br>over glass<br>passivated junction | Matte Tin-plated leads, Solderable per JESD22-B102D | Color band denotes cathode except Bidirectional. | Any               | See Marking Code List | 0.003 ounce,<br>0.095 grams |

**MAX. RATING & CHARACTERISTICS - Ratings at 25°C Ambient Temperature Unless Otherwise Specified.**

| Parameter   | SYMBOLS    | VALUE                      | UNITS    |
|---|------------|----------------------------|----------|
| Peak Pulse Power Dissipation on TA=25°C by 10x1000µs waveform (Note 1,2, Fig 1) | P ppm      | 600                        | W        |
| Peak Forward Surge Current 8.3ms Single Half Sine Wave (Note 3)                 | I FSM      | 100                        | A        |
| Power Dissipation on infinite heat sink at T A=50°C                             | P M(AV)    | 5.0                        | W        |
| Maximum Instantaneous Forward Voltage at 50A for Unidirectional only            | V F        | 3.5/5.0                    | V        |
| Peak Pulse Current on 10/1000 us waveform (Note 1)                              | I PPM      | <i>See Table 1~Table 6</i> | W        |
| Typical Thermal Resistance Junction (Note 2)                                    | to Ambient | R θJA                      | 100 °C/W |
|   | to Lead    | R θJL                      | 20 °C/W  |
| Operating junction temperature range  | T J        | -65 ~ +150                 | °C       |
| Storage temperature range   | T stg      | -65 ~ +150                 | °C       |

**Notes**

1. Non-repetitive current pulse, per Fig 3 and derated above T A=25 °C per Fig 2
2. Mounted on 5.0\*5.0mm (0.2 x 0.2") copper pads to each terminal
3. VF<3.5V for devices of VBR<200V and VF<5.0V for devices of VBR>201V

# SMD TRANSIENT VOLTAGE SUPPRESSORS DIODES SMB SERIES

**UNIDIRECTIONAL TYPE- ELECTRICAL CHARACTERISTICS - Ta = 25°C**

Table 1

| Part Code      | Reverse Stand-off Voltage | Breakdown Voltage |      | Test Current | Reverse Leakage Max. | Max. Clamp Voltage | Peak Pulse Current | Marking Code |
|----------------|---------------------------|-------------------|------|--------------|----------------------|--------------------|--------------------|--------------|
|                |                           | V BR @ I T        |      |              |                      |                    |                    |              |
|                | V RMV                     | Min               | Max  | I T          | I R @ V RWM          | V C @ I PPM        | I PPM              |              |
|                | V                         | V                 | V    | mA           | µA                   | V                  | A                  |              |
| SMBP6SMB6V8ASA | 5.8                       | 6.45              | 7.14 | 10           | 1000                 | 10.5               | 58.1               | 6V8A         |
| SMBP6SMB7V5ASA | 6.4                       | 7.13              | 7.88 | 10           | 500                  | 11.3               | 54                 | 7V5A         |
| SMBP6SMB8V2ASA | 7.02                      | 7.79              | 8.61 | 10           | 200                  | 12.1               | 50.4               | 8V2A         |
| SMBP6SMB9V1ASA | 7.78                      | 8.65              | 9.55 | 1            | 50                   | 13.4               | 45.5               | 9V1A         |
| SMBP6SMB10AS0A | 8.55                      | 9.5               | 10.5 | 1            | 10                   | 14.5               | 42.1               | 10A          |
| SMBP6SMB11AS0A | 9.4                       | 10.5              | 11.6 | 1            | 5                    | 15.6               | 39.1               | 11A          |
| SMBP6SMB12AS0A | 10.2                      | 11.4              | 12.6 | 1            | 5                    | 16.7               | 36.5               | 12A          |
| SMBP6SMB13AS0A | 11.1                      | 12.4              | 13.7 | 1            | 1                    | 18.2               | 33.5               | 13A          |
| SMBP6SMB15AS0A | 12.8                      | 14.3              | 15.8 | 1            | 1                    | 21.2               | 28.8               | 15A          |
| SMBP6SMB16AS0A | 13.6                      | 15.2              | 16.8 | 1            | 1                    | 22.5               | 27.1               | 16A          |
| SMBP6SMB18AS0A | 15.3                      | 17.1              | 18.9 | 1            | 1                    | 25.5               | 24.2               | 18A          |
| SMBP6SMB20AS0A | 17.1                      | 19                | 21   | 1            | 1                    | 27.7               | 22                 | 20A          |
| SMBP6SMB22AS0A | 18.8                      | 20.9              | 23.1 | 1            | 1                    | 30.6               | 19.9               | 22A          |
| SMBP6SMB24AS0A | 20.5                      | 22.8              | 25.2 | 1            | 1                    | 33.2               | 18.4               | 24A          |
| SMBP6SMB27AS0A | 23.1                      | 25.7              | 28.4 | 1            | 1                    | 37.5               | 16.3               | 27A          |
| SMBP6SMB30AS0A | 25.6                      | 28.5              | 31.5 | 1            | 1                    | 41.4               | 14.7               | 30A          |
| SMBP6SMB33AS0A | 28.2                      | 31.4              | 34.7 | 1            | 1                    | 45.7               | 13.3               | 33A          |
| SMBP6SMB36AS0A | 30.8                      | 34.2              | 37.8 | 1            | 1                    | 49.9               | 12.2               | 36A          |
| SMBP6SMB39AS0A | 33.3                      | 37.1              | 41   | 1            | 1                    | 53.9               | 11.3               | 39A          |

# SMD TRANSIENT VOLTAGE SUPPRESSORS DIODES SMB SERIES

**UNIDIRECTIONAL TYPE- ELECTRICAL CHARACTERISTICS - Ta = 25°C**

Table 2

| Part Code      | Reverse Stand-off Voltage | Breakdown Voltage |      | Test Current | Reverse Leakage Max. | Max. Clamp Voltage | Peak Pulse Current | Marking Code |
|----------------|---------------------------|-------------------|------|--------------|----------------------|--------------------|--------------------|--------------|
|                |                           | V BR @ I T        |      |              |                      |                    |                    |              |
|                | V RMV                     | Min               | Max  | I T          | I R @ V RWM          | V C @ I PPM        | I PPM              |              |
|                | V                         | V                 | V    | mA           | µA                   | V                  | A                  |              |
| SMBP6SMB43AS0A | 36.8                      | 40.9              | 45.2 | 1            | 1                    | 59.3               | 10.3               | 43A          |
| SMBP6SMB47AS0A | 40.2                      | 44.7              | 49.4 | 1            | 1                    | 64.8               | 9.4                | 47A          |
| SMBP6SMB51AS0A | 43.6                      | 48.5              | 53.6 | 1            | 1                    | 70.1               | 8.7                | 51A          |
| SMBP6SMB56AS0A | 47.8                      | 53.2              | 58.8 | 1            | 1                    | 77                 | 7.9                | 56A          |
| SMBP6SMB62AS0A | 53                        | 58.9              | 65.1 | 1            | 1                    | 85                 | 7.2                | 62A          |
| SMBP6SMB68AS0A | 58.1                      | 64.6              | 71.4 | 1            | 1                    | 92                 | 6.6                | 68A          |
| SMBP6SMB75AS0A | 64.1                      | 71.3              | 78.8 | 1            | 1                    | 103                | 5.9                | 75A          |
| SMBP6SMB82AS0A | 70.1                      | 77.9              | 86.1 | 1            | 1                    | 113                | 5.4                | 82A          |
| SMBP6SMB91AS0A | 77.8                      | 86.5              | 95.5 | 1            | 1                    | 125                | 4.9                | 91A          |
| SMBP6SMB100ASA | 85.5                      | 95                | 105  | 1            | 1                    | 137                | 4.5                | 100A         |
| SMBP6SMB110ASA | 94                        | 105               | 116  | 1            | 1                    | 152                | 4                  | 110A         |
| SMBP6SMB120ASA | 102                       | 114               | 126  | 1            | 1                    | 165                | 3.7                | 120A         |
| SMBP6SMB130ASA | 111                       | 124               | 137  | 1            | 1                    | 179                | 3.4                | 130A         |
| SMBP6SMB150ASA | 128                       | 143               | 158  | 1            | 1                    | 207                | 2.9                | 150A         |
| SMBP6SMB160ASA | 136                       | 152               | 168  | 1            | 1                    | 219                | 2.8                | 160A         |
| SMBP6SMB170ASA | 145                       | 162               | 179  | 1            | 1                    | 234                | 2.6                | 170A         |
| SMBP6SMB180ASA | 154                       | 171               | 189  | 1            | 1                    | 246                | 2.5                | 180A         |
| SMBP6SMB200ASA | 171                       | 190               | 210  | 1            | 1                    | 274                | 2.2                | 200A         |
| SMBP6SMB220ASA | 185                       | 209               | 231  | 1            | 1                    | 328                | 1.9                | 220A         |

**SMD TRANSIENT VOLTAGE SUPPRESSORS DIODES SMB SERIES**

**UNIDIRECTIONAL TYPE- ELECTRICAL CHARACTERISTICS - Ta = 25°C**

Table 3

| Part Code      | Reverse Stand-off Voltage | Breakdown Voltage |       | Test Current | Reverse Leakage Max. | Max. Clamp Voltage | Peak Pulse Current | Marking Code |
|----------------|---------------------------|-------------------|-------|--------------|----------------------|--------------------|--------------------|--------------|
|                |                           | V BR @ I T        |       |              |                      |                    |                    |              |
|                | V RMV                     | Min               | Max   | I T          | I R @ V RWM          | V C @ I PPM        | I PPM              |              |
|                | V                         | V                 | V     | mA           | µA                   | V                  | A                  |              |
| SMBP6SMB250ASA | 214                       | 237               | 263   | 1            | 1                    | 344                | 1.8                | 250A         |
| SMBP6SMB300ASA | 256                       | 285               | 315   | 1            | 1                    | 414                | 1.5                | 300A         |
| SMBP6SMB350ASA | 300                       | 332               | 368   | 1            | 1                    | 482                | 1.3                | 350A         |
| SMBP6SMB400ASA | 342                       | 380               | 420   | 1            | 1                    | 548                | 1.1                | 400A         |
| SMBP6SMB440ASA | 376                       | 418               | 462   | 1            | 1                    | 602                | 1                  | 440A         |
| SMBP6SMB480ASA | 408                       | 456               | 504   | 1            | 1                    | 658                | 0.9                | 480A         |
| SMBP6SMB510ASA | 434                       | 485               | 535   | 1            | 1                    | 698                | 0.9                | 510A         |
| SMBP6SMB530ASA | 477                       | 503.5             | 556.5 | 1            | 1                    | 725                | 0.8                | 530A         |
| SMBP6SMB540ASA | 486                       | 513               | 567   | 1            | 1                    | 740                | 0.8                | 540A         |
| SMBP6SMB550ASA | 495                       | 522.5             | 577.5 | 1            | 1                    | 760                | 0.8                | 550A         |

**SMD TRANSIENT VOLTAGE SUPPRESSORS DIODES SMB SERIES**
**BIDIRECTIONAL TYPE- ELECTRICAL CHARACTERISTICS - Ta = 25°C**

Table 4

| Part Code             | Reverse Stand-off Voltage | Breakdown Voltage |             | Test Current | Reverse Leakage Max. | Max. Clamp Voltage | Peak Pulse Current | Marking Code |
|-----------------------|---------------------------|-------------------|-------------|--------------|----------------------|--------------------|--------------------|--------------|
|                       |                           | V BR @ I T        |             |              |                      |                    |                    |              |
|                       | V RMV                     | Min               | Max         | I T          | I R @ V RWM          | V C @ I PPM        | I PPM              |              |
|                       | V                         | V                 | V           | mA           | µA                   | V                  | A                  |              |
| SMBP6SMB6V8CAC        | 5.8V                      | 6.45              | 7.14        | 10           | 1000                 | 10.5               | 58.1               | 6V8C         |
| SMBP6SMB7V5CAC        | 6.4                       | 7.13              | 7.88        | 10           | 500                  | 11.3               | 54                 | 7V5C         |
| SMBP6SMB8V2CAC        | 7.02                      | 7.79              | 8.61        | 10           | 200                  | 12.1               | 50.4               | 8V2C         |
| SMBP6SMB9V1CAC        | 7.78                      | 8.65              | 9.55        | 1            | 50                   | 13.4               | 45.5               | 9V1C         |
| SMBP6SMB10CASC        | 8.55                      | 9.5               | 10.5        | 1            | 10                   | 14.5               | 42.1               | 10C          |
| SMBP6SMB11CASC        | 9.4                       | 10.5              | 11.6        | 1            | 5                    | 15.6               | 39.1               | 11C          |
| SMBP6SMB12CASC        | 10.2                      | 11.4              | 12.6        | 1            | 5                    | 16.7               | 36.5               | 12C          |
| SMBP6SMB13CASC        | 11.1                      | 12.4              | 13.7        | 1            | 1                    | 18.2               | 33.5               | 13C          |
| SMBP6SMB15CASC        | 12.8                      | 14.3              | 15.8        | 1            | 1                    | 21.2               | 28.8               | 15C          |
| SMBP6SMB16CASC        | 13.6                      | 15.2              | 16.8        | 1            | 1                    | 22.5               | 27.1               | 16C          |
| SMBP6SMB18CASC        | 15.3                      | 17.1              | 18.9        | 1            | 1                    | 25.5               | 24.2               | 18C          |
| SMBP6SMB20CASC        | 17.1                      | 19                | 21          | 1            | 1                    | 27.7               | 22                 | 20C          |
| SMBP6SMB22CASC        | 18.8                      | 20.9              | 23.1        | 1            | 1                    | 30.6               | 19.9               | 22C          |
| SMBP6SMB24CASC        | 20.5                      | 22.8              | 25.2        | 1            | 1                    | 33.2               | 18.4               | 24C          |
| SMBP6SMB27CASC        | 23.1                      | 25.7              | 28.4        | 1            | 1                    | 37.5               | 16.3               | 27C          |
| SMBP6SMB30CASC        | 25.6                      | 28.5              | 31.5        | 1            | 1                    | 41.4               | 14.7               | 30C          |
| SMBP6SMB33CASC        | 28.2                      | 31.4              | 34.7        | 1            | 1                    | 45.7               | 13.3               | 33C          |
| <b>SMBP6SMB36CASC</b> | <b>30.8</b>               | <b>34.2</b>       | <b>37.8</b> | <b>1</b>     | <b>1</b>             | <b>49.9</b>        | <b>12.2</b>        | <b>36C</b>   |
| SMBP6SMB39CASC        | 33.3                      | 37.1              | 41          | 1            | 1                    | 53.9               | 11.3               | 39C          |



**SMD TRANSIENT VOLTAGE SUPPRESSORS DIODES SMB SERIES**
**BIDIRECTIONAL TYPE- ELECTRICAL CHARACTERISTICS - Ta = 25°C**

Table 5

| Part Code      | Reverse Stand-off Voltage | Breakdown Voltage |      | Test Current | Reverse Leakage Max. | Max. Clamp Voltage | Peak Pulse Current | Marking Code |
|----------------|---------------------------|-------------------|------|--------------|----------------------|--------------------|--------------------|--------------|
|                |                           | V BR @ I T        |      |              |                      |                    |                    |              |
|                | V RMV                     | Min               | Max  | I T          | I R @ V RWM          | V C @ I PPM        | I PPM              |              |
|                | V                         | V                 | V    | mA           | µA                   | V                  | A                  |              |
| SMBP6SMB43CASC | 36.8                      | 40.9              | 45.2 | 1            | 1                    | 59.3               | 10.3               | 43C          |
| SMBP6SMB47CASC | 40.2                      | 44.7              | 49.4 | 1            | 1                    | 64.8               | 9.4                | 47C          |
| SMBP6SMB51CASC | 43.6                      | 48.5              | 53.6 | 1            | 1                    | 70.1               | 8.7                | 51C          |
| SMBP6SMB56CASC | 47.8                      | 53.2              | 58.8 | 1            | 1                    | 77                 | 7.9                | 56C          |
| SMBP6SMB62CASC | 53                        | 58.9              | 65.1 | 1            | 1                    | 85                 | 7.2                | 62C          |
| SMBP6SMB68CASC | 58.1                      | 64.6              | 71.4 | 1            | 1                    | 92                 | 6.6                | 68C          |
| SMBP6SMB75CASC | 64.1                      | 71.3              | 78.8 | 1            | 1                    | 103                | 5.9                | 75C          |
| SMBP6SMB82CASC | 70.1                      | 77.9              | 86.1 | 1            | 1                    | 113                | 5.4                | 82C          |
| SMBP6SMB91CASC | 77.8                      | 86.5              | 95.5 | 1            | 1                    | 125                | 4.9                | 91C          |
| SMBP6SMB100CAC | 85.5                      | 95                | 105  | 1            | 1                    | 137                | 4.5                | 100C         |
| SMBP6SMB110CAC | 94                        | 105               | 116  | 1            | 1                    | 152                | 4                  | 110C         |
| SMBP6SMB120CAC | 102                       | 114               | 126  | 1            | 1                    | 165                | 3.7                | 120C         |
| SMBP6SMB130CAC | 111                       | 124               | 137  | 1            | 1                    | 179                | 3.4                | 130C         |
| SMBP6SMB150CAC | 128                       | 143               | 158  | 1            | 1                    | 207                | 2.9                | 150C         |
| SMBP6SMB160CAC | 136                       | 152               | 168  | 1            | 1                    | 219                | 2.8                | 160C         |
| SMBP6SMB170CAC | 145                       | 162               | 179  | 1            | 1                    | 234                | 2.6                | 170C         |
| SMBP6SMB180CAC | 154                       | 171               | 189  | 1            | 1                    | 246                | 2.5                | 180C         |
| SMBP6SMB200CAC | 171                       | 190               | 210  | 1            | 1                    | 274                | 2.2                | 200C         |
| SMBP6SMB220CAC | 185                       | 209               | 231  | 1            | 1                    | 328                | 1.9                | 220C         |

**SMD TRANSIENT VOLTAGE SUPPRESSORS DIODES SMB SERIES**

**BIDIRECTIONAL TYPE- ELECTRICAL CHARACTERISTICS - Ta = 25°C**

Table 6

| Part Code      | Reverse Stand-off Voltage | Breakdown Voltage |       | Test Current | Reverse Leakage Max. | Max. Clamp Voltage | Peak Pulse Current | Marking Code |
|----------------|---------------------------|-------------------|-------|--------------|----------------------|--------------------|--------------------|--------------|
|                |                           | V BR @ I T        |       |              |                      |                    |                    |              |
|                | V RMV                     | Min               | Max   | I T          | I R @ V RWM          | V C @ I PPM        | I PPM              |              |
|                | V                         | V                 | V     | mA           | µA                   | V                  | A                  |              |
| SMBP6SMB250CAC | 214                       | 237               | 263   | 1            | 1                    | 344                | 1.8                | 250C         |
| SMBP6SMB300CAC | 256                       | 285               | 315   | 1            | 1                    | 414                | 1.5                | 300C         |
| SMBP6SMB350CAC | 300                       | 332               | 368   | 1            | 1                    | 482                | 1.3                | 350C         |
| SMBP6SMB400CAC | 342                       | 380               | 420   | 1            | 1                    | 548                | 1.1                | 400C         |
| SMBP6SMB440CAC | 376                       | 418               | 462   | 1            | 1                    | 602                | 1                  | 440C         |
| SMBP6SMB480CAC | 408                       | 456               | 504   | 1            | 1                    | 658                | 0.9                | 480C         |
| SMBP6SMB510CAC | 434                       | 485               | 535   | 1            | 1                    | 698                | 0.9                | 510C         |
| SMBP6SMB530CAC | 477                       | 503.5             | 556.5 | 1            | 1                    | 725                | 0.8                | 530C         |
| SMBP6SMB540CAC | 486                       | 513               | 567   | 1            | 1                    | 740                | 0.8                | 540C         |
| SMBP6SMB550CAC | 495                       | 522.5             | 577.5 | 1            | 1                    | 760                | 0.8                | 550C         |

# SMD TRANSIENT VOLTAGE SUPPRESSORS DIODES SMB SERIES

**RELIABILITY**

| Number | Experiment Items                   | Experiment Method And Conditions   | Reference Documents             |
|--------|------------------------------------|--|---------------------------------|
| 1      | Solder Resistance Test             | Test 260°C± 5°C for 10 ± 2 sec.<br>Immerse body into solder 1/16" ± 1/32"                                      | MIL-STD-750D<br>METHOD-2031.2   |
| 2      | Solderability Test                 | 230°C ±5°C for 5 sec.  | MIL-STD-750D<br>METHOD-2026.1 0 |
| 3      | Pull Test                          | 1 kg in axial lead direction for 10 sec.   | MIL-STD-750D<br>METHOD-2036.4   |
| 4      | Bend Test                          | 0.5Kg Weight Applied To Each Lead,<br>Bending Arcs 90 °C ± 5 °C For 3 Times                                    | MIL-STD-750D<br>METHOD-2036.4   |
| 5      | High Temperature Reverse Bias Test | TA=100°C for 1000 Hours at VR=80%<br>Rated VR  | MIL-STD-750D<br>METHOD-1038.4   |
| 6      | Forward Operation Life Test        | TA=25°C Rated Average Rectified<br>Current   | MIL-STD-750D<br>METHOD-1027.3   |
| 7      | Intermittent Operation Life Test   | On state: 5 min with rated IRMS Power<br>Off state: 5 min with Cool Forced Air.<br>On and off for 1000 cycles. | MIL-STD-750D<br>METHOD-1036.3   |
| 8      | Pressure Cooker Test               | 15 PSIG, TA=121°C, 4 hours   | MIL-S-19500<br>APPENOIXC        |
| 9      | Temperature Cycling Test           | -55°C~+125°C; 30 Minutes For Dwelled<br>Time 5 minutes for transferred time.<br>Total: 10 cycles.              | MIL-STD-750D<br>METHOD-1051.7   |
| 10     | Thermal Shock Test                 | 0°C for 5 minutes., 100°C for 5minutes,<br>Total: 10 cycles  | MIL-STD-750D<br>METHOD-1056.7   |
| 11     | Forward Surge Test                 | 8.3ms Single Sale Sine-wave One Surge.   | MIL-STD-750D<br>METHOD-4066.4   |
| 12     | Humidity Test                      | TA=65°C, RH=98% for 1000 hours.  | MIL-STD-750D<br>METHOD-1021.3   |
| 13     | High Temperature Storage life Test | 150°C for 1000 Hours   | MIL-STD-750D<br>METHOD-1031.5   |

**SMD TRANSIENT VOLTAGE SUPPRESSORS DIODES SMB SERIES**

**SUGGESTED REFLOW PROFILE (For Reference Only)**



|  |                                  |                   |
|--|----------------------------------|-------------------|
| <b>Profile Feature</b>                                 |                                  | Pb-Free Assembly  |
| <b>Average Ramp-up Rate (Ts Max to Tp)</b>             |                                  | 3°C/second Max    |
| <b>Preheat</b>   | <b>Temperature Min (Ts Min.)</b> | 150°C             |
|  | <b>Temperature Max (Ts Max.)</b> | 200°C             |
|  | <b>Time (ts Min. to ts Max.)</b> | 60 ~ 180 seconds  |
| <b>Time maintained above</b>                           | <b>Temperature (Tl)</b>          | 217°C             |
|  | <b>Time (tl)</b>                 | 60 ~ 150 seconds  |
| <b>Peak/Classification Temperature (Tp)</b>            |                                  | 260 °C            |
| <b>Time within 5°C of actual Peak Temperature (tp)</b> |                                  | 20 ~ 40 seconds   |
| <b>Ramp-down rate</b>                                  |                                  | 6 °C /Second Max. |
| <b>Time 25 °C to Peak Temperature</b>                  |                                  | 8 minutes Max.    |
| <b>Suggest reflow times</b>                            |                                  | 3 Times Max.      |

**SMD TRANSIENT VOLTAGE SUPPRESSORS DIODES SMB SERIES**

**RATINGS AND CHARACTERISTIC CURVES (For Reference Only) - Ta= 25°C Unless Otherwise Specified**

Figure 1. Peak Pulse Power Rating Curve

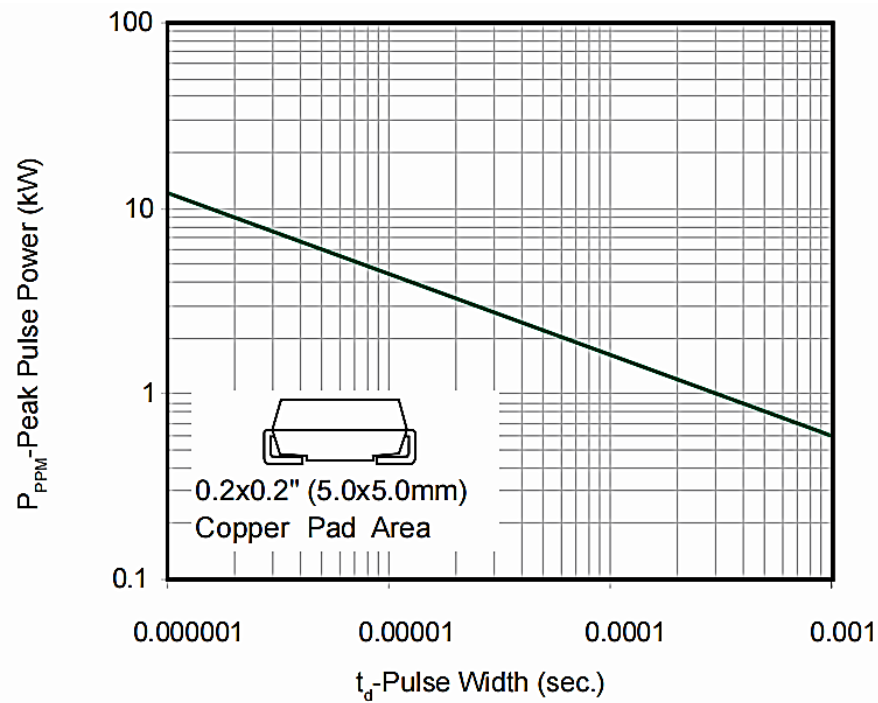
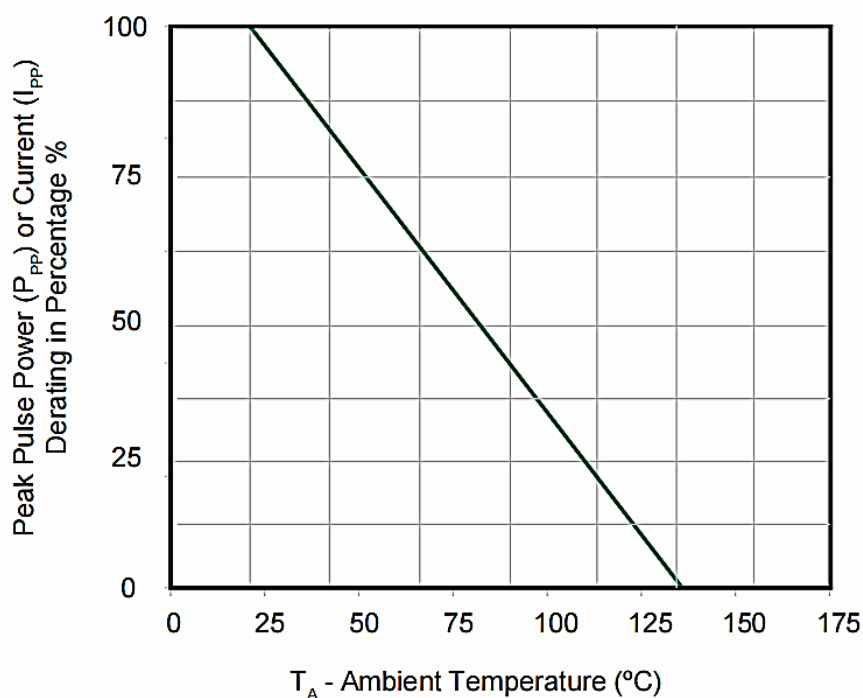

Figure 2. Pulse Derating Curve



**SMD TRANSIENT VOLTAGE SUPPRESSORS DIODES SMB SERIES**

RATINGS AND CHARACTERISTIC CURVES (For Reference Only) - Ta= 25°C Unless Otherwise Specified

Figure 3. Pulse Waveform

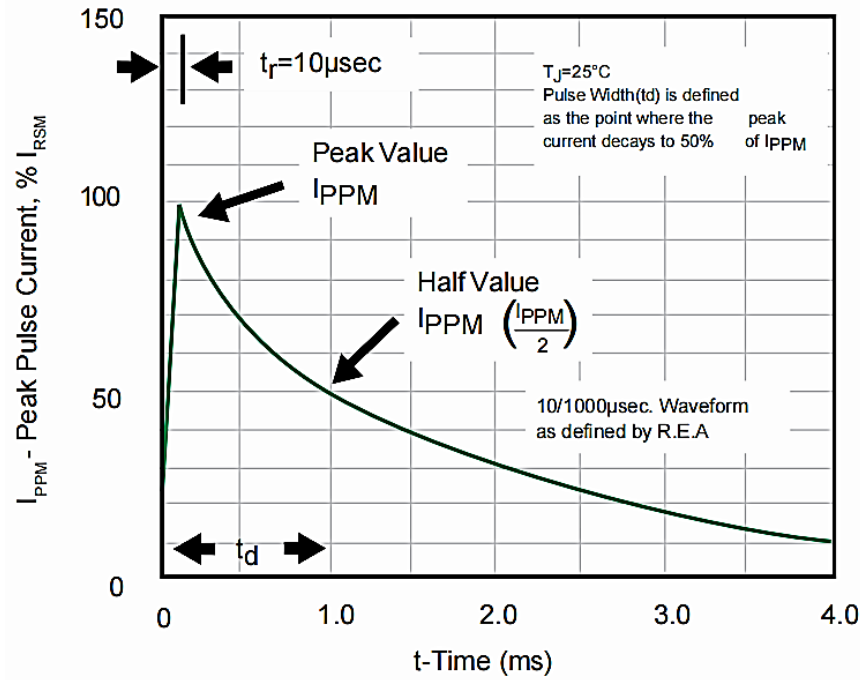
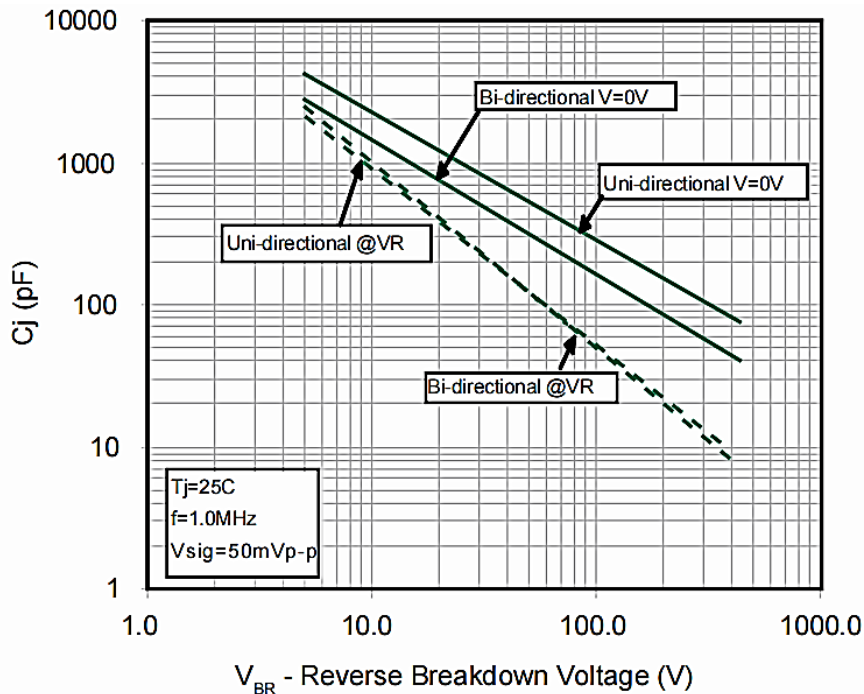

Figure 4. Typical Junction Capacitance



**SMD TRANSIENT VOLTAGE SUPPRESSORS DIODES SMB SERIES**

**RATINGS AND CHARACTERISTIC CURVES (For Reference Only) - Ta= 25°C Unless Otherwise Specified**

Figure 5. Steady State Power Dissipation Derating Curve

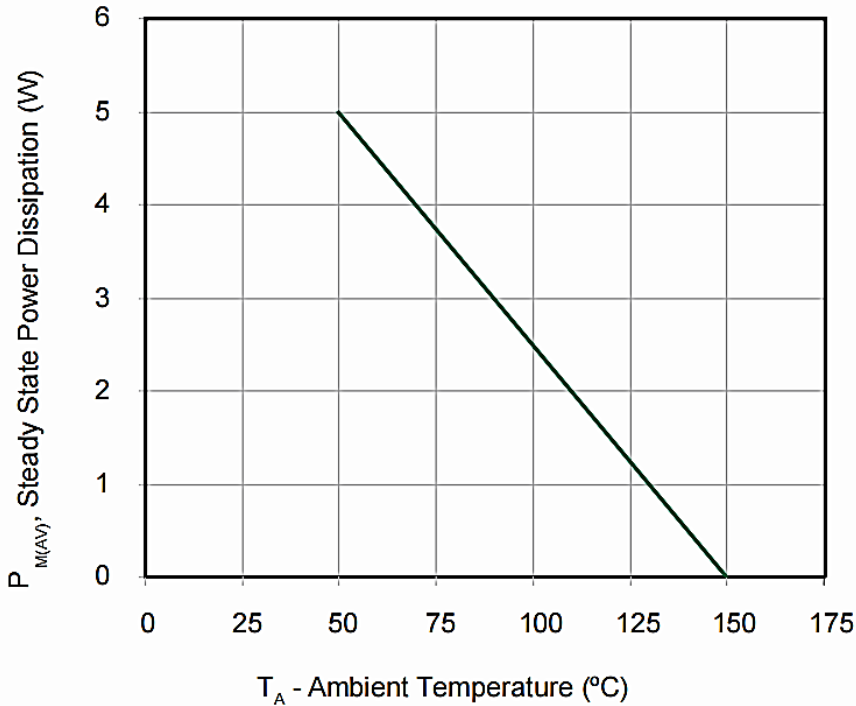
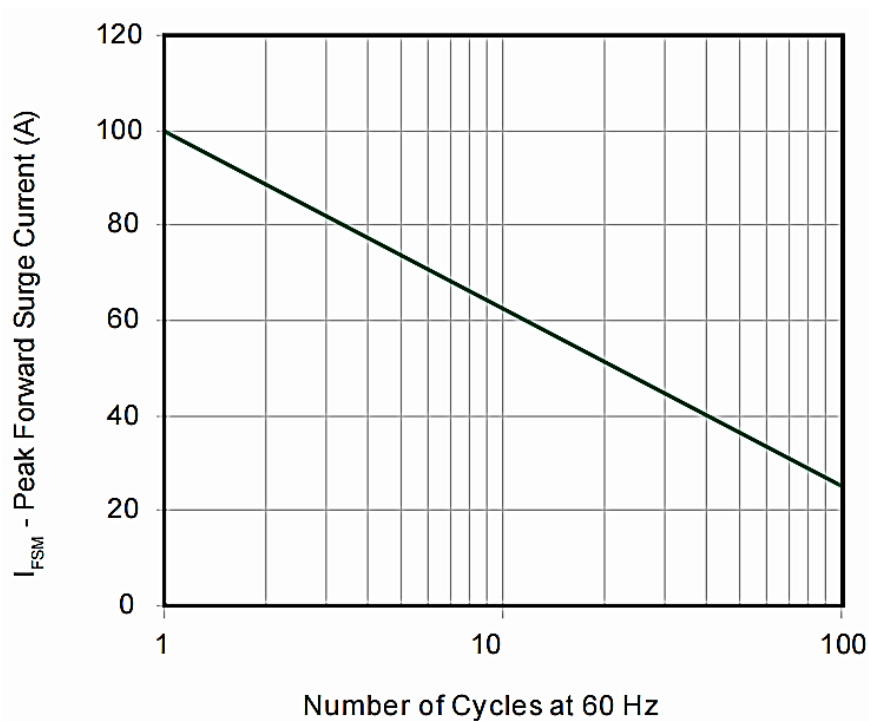

Figure 6. Maximum Non-Repetitive Peak Forward Surge Current Uni-Directional Only



**SMD TRANSIENT VOLTAGE SUPPRESSORS DIODES SMB SERIES**

**TAPE/REEL (Unit: mm)**

All Devices are packed in accordance with EIA standard RS-481-A and specifications.

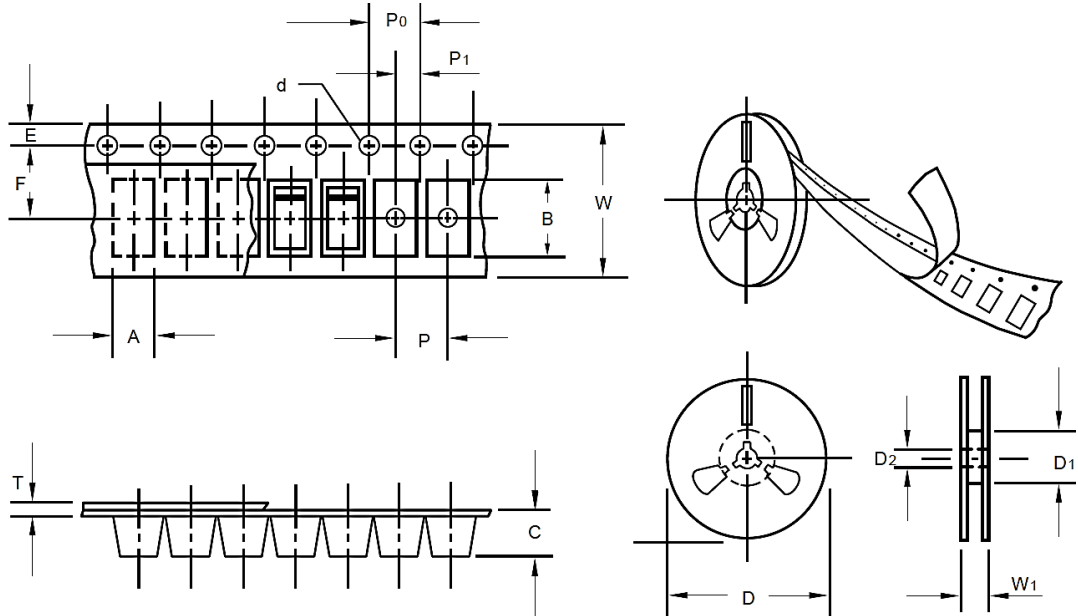

| Item                     | Symbol | Tolerance | SMB/DO-214AA |
|--------------------------|--------|-----------|--------------|
| Carrier width            | A      | 0.1       | 3.81         |
| Carrier Length           | B      | 0.1       | 5.41         |
| Carrier Depth            | C      | 0.1       | 2.42         |
| Sprocket hole            | d      | 0.05      | 1.50         |
| 13"Reel outside diameter | D      | 2.0       | 330.00       |
| 13"Reel inner diameter   | D1     | Min.      | 50.00        |
| 7"Reel outside diameter  | -      | -         | -            |
| 7"Reel inner diameter    | -      | -         | -            |
| Feed hole diameter       | D2     | 0.5       | 13.00        |
| Sprocket hole position   | E      | 0.1       | 1.75         |
| Punch hole position      | F      | 0.1       | 5.55         |
| Punch hole pitch         | P      | 0.1       | 8.00         |
| Sprocket hole pitch      | P0     | 0.1       | 4.00         |
| Embossment center        | P1     | 0.1       | 2.00         |
| Overall tape thickness   | T      | 0.1       | 0.30         |
| Tape width               | W      | 0.3       | 12.00        |
| Reel width               | W1     | 1.0       | 12.30        |



**SMD TRANSIENT VOLTAGE SUPPRESSORS DIODES SMB SERIES**

**PACKAGE For Reference Only**

| Case Code | SMB      |
|-----------|----------|
| Reel Size | 13"      |
| Reel Size | 330 mm   |
| SPQ/Reel  | 3000 pcs |
| Qty. /Box | 6000 pcs |
| G.W/Box   | /        |

**GENERAL RETURN/REFUND POLICY**

NextGen requires that customers first obtain an RMA (Returned Merchandise Authorization) number prior to returning any products. Returns must be made within 30 days of the date of invoice, be in the original packaging, unused and like-new condition. At the time of quoting or purchasing, a product may say that it is Non-Cancelable/Non-Returnable (NCNR). These products are not returnable and not refundable.

**IMPORTANT NOTICE AND DISCLAIMER**

- 1) NextGen Component, Inc. reserves the right to make changes to this document and its products and specifications at any time without notice. Customers should obtain and confirm the latest product information and specifications before final design, purchase or use.
- 2) NextGen Component, Inc makes no warranty, representation or guarantee regarding the suitability of its products for any particular purpose, not does NextGen Component, Inc assume any liability for application assistance or customer product design.
- 3) NextGen Component, Inc does not warrant or accept any liability with products which are purchased or used for any unintended or unauthorized application. No license is granted by implication or otherwise under any intellectual property rights of NextGen Component, Inc
- 4) NextGen Component, Inc. products are not authorized for use as critical components in life support devices or systems without express written approval of NextGen Component, Inc.