



cDAQ-T4202

CompactDAQ Temperature Measurement Bundle

Datasheet and Specifications

cDAQ 9174 and NI-9213

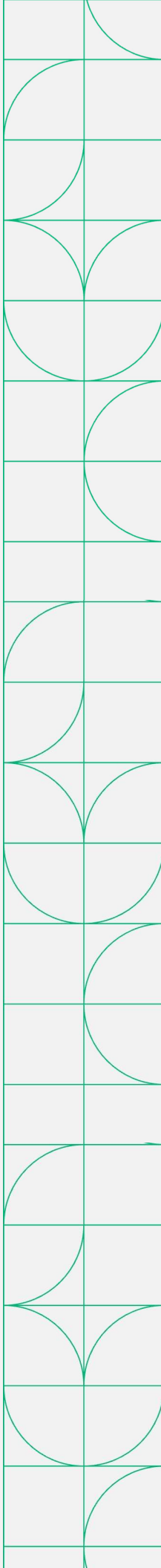

CompactDAQ Temperature Measurement Bundle

In-Box Components

cDAQ-T4202

System P/N: 868014-01



cDAQ-9174
(4-slot CompactDAQ Chassis
w/ Desktop Mounting)



NI-9213 (x2)
(Temperature Input Module)

Included Accessories:

- cRIO-9940 Backshell
- Desktop Mounting Kit
- USB A to B Cable
- AC/DC Power Supply*

*IEC Power Cord sold separately
based on geographic region

Recommended Software

FlexLogger

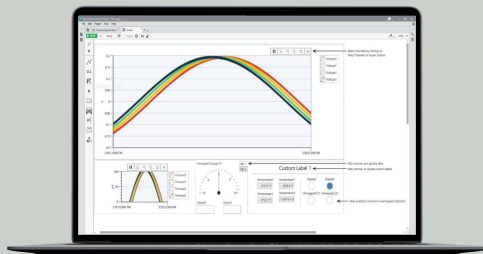

P/N: 785748-3501

No code software that accelerates measurement configuration and logging with NI DAQ Hardware.

- Acquire data and log test results to .tdms or .csv files
- Inline calculations for simple math, filtering, Boolean logic, and more
- Integrated TDMS Viewer for interactive data review

Table of Contents

This document combines the PDFs of this system together. The page numbers in the table of contents correspond to the page number of PDF the component's documentation begins.

cDAQ 9174 Specifications.....	3
NI-9213 Specifications.....	14
cRIO-9940 Dimensional Drawings.....	29

cDAQ-9174

Specifications



SPECIFICATIONS

NI cDAQ™ -9174

NI CompactDAQ Four-Slot USB Chassis

These specifications are for the National Instruments CompactDAQ 9174 chassis only. These specifications are typical at 25 °C unless otherwise noted. For the C Series I/O module specifications, refer to the documentation for the C Series I/O module you are using.

Analog Input

Input FIFO size.....	127 samples per slot
Maximum sample rate ¹	Determined by the C Series I/O module or modules
Timing accuracy ²	50 ppm of sample rate
Timing resolution ³	12.5 ns
Number of channels supported.....	Determined by the C Series I/O module or modules

Analog Output

Number of channels supported	
Hardware-timed task	
Onboard regeneration.....	16
Non-regeneration.....	Determined by the C Series I/O module or modules

¹ Performance dependent on type of installed C Series I/O module and number of channels in the task.

² Does not include group delay. For more information, refer to the documentation for each C Series I/O module.

³ Does not include group delay. For more information, refer to the documentation for each C Series I/O module.

Non-hardware-timed task.....	Determined by the C Series I/O module or modules
Maximum update rate	
Onboard regeneration.....	1.6 MS/s (multi-channel, aggregate)
Non-regeneration.....	Determined by the C Series I/O module or modules
Timing accuracy.....	50 ppm of sample rate
Timing resolution.....	12.5 ns
Output FIFO size	
Onboard regeneration.....	8,191 samples shared among channels used
Non-regeneration.....	127 samples per slot
AO waveform modes.....	Non-periodic waveform, periodic waveform regeneration mode from onboard memory, periodic waveform regeneration from host buffer including dynamic update

Digital Waveform Characteristics

Waveform acquisition (DI) FIFO.....	127 samples per slot
Waveform generation (DO) FIFO.....	2,047 samples
Digital input sample clock frequency	
Streaming to application.....	System-dependent memory
Finite.....	0 to 10 MHz
Digital output sample clock frequency	
Streaming from application.....	System-dependent memory
Regeneration from FIFO.....	0 to 10 MHz
Finite.....	0 to 10 MHz
Timing accuracy.....	50 ppm

General-Purpose Counters/Timers

Number of counters/timers.....	4
Resolution.....	32 bits
Counter measurements.....	Edge counting, pulse, semi-period, period, two-edge separation, pulse width
Position measurements.....	X1, X2, X4 quadrature encoding with Channel Z reloading; two-pulse encoding
Output applications.....	Pulse, pulse train with dynamic updates, frequency division, equivalent time sampling
Internal base clocks.....	80 MHz, 20 MHz, 100 kHz
External base clock frequency.....	0 to 20 MHz
Base clock accuracy.....	50 ppm
Output frequency.....	0 to 20 MHz
Inputs.....	Gate, Source, HW_Arm, Aux, A, B, Z, Up_Down
Routing options for inputs.....	Any module PFI, analog trigger, many internal signals
FIFO.....	Dedicated 127-sample FIFO

Frequency Generator

Number of channels.....	1
Base clocks.....	20 MHz, 10 MHz, 100 kHz
Divisors.....	1 to 16 (integers)
Base clock accuracy.....	50 ppm
Output.....	Any module PFI terminal

Module PFI Characteristics

Functionality.....	Static digital input, static digital output, timing input, and timing output
Timing output sources ⁴	Many analog input, analog output, counter, digital input, and digital output timing signals
Timing input frequency.....	0 to 20 MHz
Timing output frequency.....	0 to 20 MHz

Digital Triggers

Source.....	Any module PFI terminal
Polarity.....	Software-selectable for most signals
Analog input function.....	Start Trigger, Reference Trigger, Pause Trigger, Sample Clock, Sample Clock Timebase
Analog output function.....	Start Trigger, Pause Trigger, Sample Clock, Sample Clock Timebase
Counter/timer function.....	Gate, Source, HW_Arm, Aux, A, B, Z, Up_Down

Module I/O States

At power-on.....	Module-dependent. Refer to the documentation for each C Series I/O module.
------------------	--



Note The chassis may revert the input/output of the modules to their power-on state when the USB cable is removed.

⁴ Actual signals available dependent on type of installed C Series I/O module.

Power Requirements



Caution You must use a National Electric Code (NEC) Class 2 power source with the NI cDAQ-9174 chassis.



Note Some C Series I/O modules have additional power requirements. For more information about C Series I/O module power requirements, refer to the documentation for each C Series I/O module.



Note Sleep mode for C Series I/O modules is not supported in the NI cDAQ-9174.

Input voltage range.....	9 to 30 V
Maximum required input power ⁵	15 W
Power input connector.....	2 positions 3.5 mm pitch pluggable screw terminal with screw locks similar to Sauro CTMH020F8-0N001
Power input mating connector.....	Sauro CTF020V8, Phoenix Contact 1714977, or equivalent
Power consumption from USB,.....	500 μ A maximum 4.10 to 5.25 V

Bus Interface

USB specification.....	USB 2.0 Hi-Speed
High-performance data streams.....	7
Data stream types available.....	Analog input, analog output, digital input, digital output, counter/timer input, counter/timer output, NI-XNET ⁶



Note If you are connecting the NI cDAQ-9174 chassis to a USB hub, the hub must be externally powered.

⁵ Includes maximum 1 W module load per slot across rated temperature and product variations.

⁶ When a session is active, CAN or LIN (NI-XNET) C Series modules use a total of two data streams regardless of the number of NI-XNET modules in the chassis.

Physical Characteristics

Weight (unloaded).....Approx. 574 g (20.2 oz)

Dimensions (unloaded).....159.5 mm × 88.1 mm × 58.9 mm
 (6.28 in. × 3.47 in. × 2.3 in.) Refer to the following figure.

If you need to clean the chassis, wipe it with a dry towel.

Figure 1. NI cDAQ-9174 Dimensions

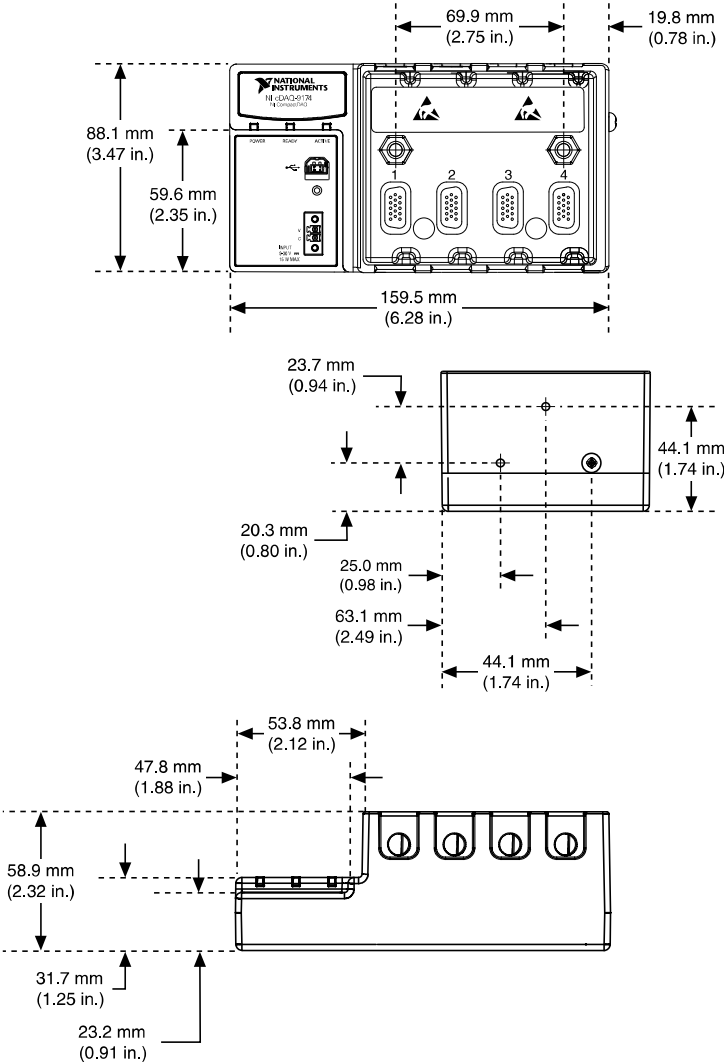

Environmental

Operating temperature ⁷	-20 °C to 55 °C (IEC-60068-2-1 and IEC-60068-2-2)
Storage temperature.....	-40 °C to 85 °C (IEC-60068-2-1 and IEC-60068-2-2)
Ingress protection.....	IP 30
Operating humidity.....	10 to 90% RH, noncondensing (IEC-60068-2-56)
Storage humidity	5 to 95% RH, noncondensing (IEC-60068-2-56)
Pollution Degree (IEC 60664).....	2
Maximum altitude.....	5,000 m
Indoor use only.	

Shock and Vibration

To meet these specifications, you must panel mount the NI cDAQ-9174 system, use an NI locking USB cable, and affix ferrules to the ends of the terminal lines.

Operational shock.....	30 g peak, half-sine, 11 ms pulse (Tested in accordance with IEC 60068-2-27. Test profile developed in accordance with MIL-PRF-28800F.)
Random vibration	
Operating.....	5 to 500 Hz, 0.3 g _{rms}
Non-operating.....	5 to 500 Hz, 2.4 g _{rms} (Tested in accordance with IEC 60068-2-64. Non-operating test profile exceeds the requirements of MIL PRF-28800F, Class 3.)

⁷ When operating the NI cDAQ-9174 in temperatures below 0 °C, you must use the PS-15 power supply or another power supply rated for below 0 °C.

Safety

This product meets the requirements of the following standards of safety for electrical equipment for measurement, control, and laboratory use:

- IEC 61010-1, EN 61010-1
- UL 61010-1, CSA 61010-1



Note For UL and other safety certifications, refer to the product label or the *Online Product Certification* section.

Electromagnetic Compatibility

This product meets the requirements of the following EMC standards for electrical equipment for measurement, control, and laboratory use:

- EN 61326-1 (IEC 61326-1): Class A emissions; Basic immunity
- EN 55011 (CISPR 11): Group 1, Class A emissions
- AS/NZS CISPR 11: Group 1, Class A emissions
- FCC 47 CFR Part 15B: Class A emissions
- ICES-001: Class A emissions



Note In the United States (per FCC 47 CFR), Class A equipment is intended for use in commercial, light-industrial, and heavy-industrial locations. In Europe, Canada, Australia, and New Zealand (per CISPR 11) Class A equipment is intended for use only in heavy-industrial locations.



Note Group 1 equipment (per CISPR 11) is any industrial, scientific, or medical equipment that does not intentionally generate radio frequency energy for the treatment of material or inspection/analysis purposes.



Note For EMC declarations and certifications, refer to the *Online Product Certification* section.

CE Compliance

This product meets the essential requirements of applicable European Directives as follows:

- 2006/95/EC; Low-Voltage Directive (safety)
- 2004/108/EC; Electromagnetic Compatibility Directive (EMC)

Online Product Certification

To obtain product certifications and the DoC for this product, visit ni.com/certification, search by model number or product line, and click the appropriate link in the Certification column.

Environmental Management

NI is committed to designing and manufacturing products in an environmentally responsible manner. NI recognizes that eliminating certain hazardous substances from our products is beneficial not only to the environment but also to NI customers.

For additional environmental information, refer to the *Minimize Our Environmental Impact* web page at ni.com/environment. This page contains the environmental regulations and directives with which NI complies, as well as other environmental information not included in this document.

Waste Electrical and Electronic Equipment (WEEE)



EU Customers At the end of the product life cycle, all products must be sent to a WEEE recycling center. For more information about WEEE recycling centers, National Instruments WEEE initiatives, and compliance with WEEE Directive 2002/96/EC on Waste Electrical and Electronic Equipment, visit ni.com/environment/weee.

电子信息产品污染控制管理办法（中国 RoHS）



中国客户 National Instruments 符合中国电子信息产品中限制使用某些有害物质指令 (RoHS)。关于 National Instruments 中国 RoHS 合规性信息，请登录 ni.com/environment/rohs_china。(For information about China RoHS compliance, go to ni.com/environment/rohs_china.)

Refer to the *NI Trademarks and Logo Guidelines* at ni.com/trademarks for information on National Instruments trademarks. Other product and company names mentioned herein are trademarks or trade names of their respective companies. For patents covering National Instruments products/technology, refer to the appropriate location: **Help»Patents** in your software, the `patents.txt` file on your media, or the *National Instruments Patent Notice* at ni.com/patents. You can find information about end-user license agreements (EULAs) and third-party legal notices in the readme file for your NI product. Refer to the *Export Compliance Information* at ni.com/legal/export-compliance for the National Instruments global trade compliance policy and how to obtain relevant HTS codes, ECCNs, and other import/export data.

© 2013 National Instruments. All rights reserved.

374045A-01 May13

NI-9213

DataSheet



DATASHEET



NI 9213

16 TC, ± 78 mV, 24 Bit, 75 S/s Aggregate



- Spring-terminal connectivity
- 50 Hz/60 Hz noise rejection
- Up to 0.02 °C measurement sensitivity
- 250 Vrms, CAT II, channel-to-earth isolation

The NI 9213 is a high-density thermocouple module for CompactDAQ and CompactRIO chassis. Designed for higher-channel-count systems, the NI 9213 adds thermocouples to mixed-signal test systems without taking up too many slots.

	Kit Contents <ul style="list-style-type: none">• NI 9213• NI 9213 Getting Started Guide
	Accessories <ul style="list-style-type: none">• NI 9940 Backshell Connector Kit

C SERIES THERMOCOUPLE MODULE COMPARISON							
Product Name	Channels	Maximum Accuracy* (°C)	Sample Rate	Software Selectable OTD	Autozero	Connectivity	Isolation Continuous
NI 9211	4	2.11	14 S/s	No	Yes	Screw Terminal	250 Vrms Ch-Earth
NI 9212	8	1.29	95 S/s/ch	No	No	Isothermal Terminal Block	250 Vrms Ch-Ch
NI 9213	16	2.25	75 S/s	No	Yes	Spring Terminal	250 Vrms Ch-Earth
NI 9214	16	1.24	68 S/s	Yes	Yes	Isothermal Terminal Block	250 Vrms Ch-Earth

* For a J type thermocouple at 100 °C using high-resolution mode when applicable.

NI C Series Overview



NI provides more than 100 C Series modules for measurement, control, and communication applications. C Series modules can connect to any sensor or bus and allow for high-accuracy measurements that meet the demands of advanced data acquisition and control applications.

- Measurement-specific signal conditioning that connects to an array of sensors and signals
- Isolation options such as bank-to-bank, channel-to-channel, and channel-to-earth ground
- -40 °C to 70 °C temperature range to meet a variety of application and environmental needs
- Hot-swappable

The majority of C Series modules are supported in both CompactRIO and CompactDAQ platforms and you can move modules from one platform to the other with no modification.

CompactRIO



CompactRIO combines an open-embedded architecture with small size, extreme ruggedness, and C Series modules in a platform powered by the NI LabVIEW reconfigurable I/O (RIO) architecture. Each system contains an FPGA for custom timing, triggering, and processing with a wide array of available modular I/O to meet any embedded application requirement.

CompactDAQ

CompactDAQ is a portable, rugged data acquisition platform that integrates connectivity, data acquisition, and signal conditioning into modular I/O for directly interfacing to any sensor or signal. Using CompactDAQ with LabVIEW, you can easily customize how you acquire, analyze, visualize, and manage your measurement data.



Software

LabVIEW Professional Development System for Windows

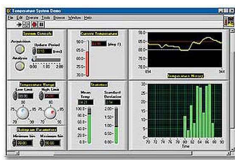

- Use advanced software tools for large project development
- Generate code automatically using DAQ Assistant and Instrument I/O Assistant
- Use advanced measurement analysis and digital signal processing
- Take advantage of open connectivity with DLLs, ActiveX, and .NET objects
- Build DLLs, executables, and MSI installers

NI LabVIEW FPGA Module

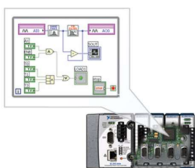

- Design FPGA applications for NI RIO hardware
- Program with the same graphical environment used for desktop and real-time applications
- Execute control algorithms with loop rates up to 300 MHz
- Implement custom timing and triggering logic, digital protocols, and DSP algorithms
- Incorporate existing HDL code and third-party IP including Xilinx IP generator functions
- Purchase as part of the LabVIEW Embedded Control and Monitoring Suite

NI LabVIEW Real-Time Module

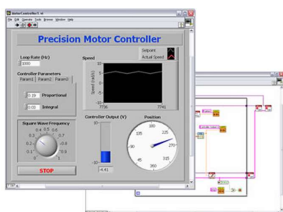

- Design deterministic real-time applications with LabVIEW graphical programming
- Download to dedicated NI or third-party hardware for reliable execution and a wide selection of I/O
- Take advantage of built-in PID control, signal processing, and analysis functions
- Automatically take advantage of multicore CPUs or set processor affinity manually
- Take advantage of real-time OS, development and debugging support, and board support
- Purchase individually or as part of a LabVIEW suite

NI 9213 Circuitry

Each channel passes through a differential filter and then is multiplexed and sampled by a 24-bit analog-to-digital converter (ADC). The channels share a common ground, COM, that is isolated from other modules in the system.

Figure 1. Input Circuitry for One Channel of the NI 9213

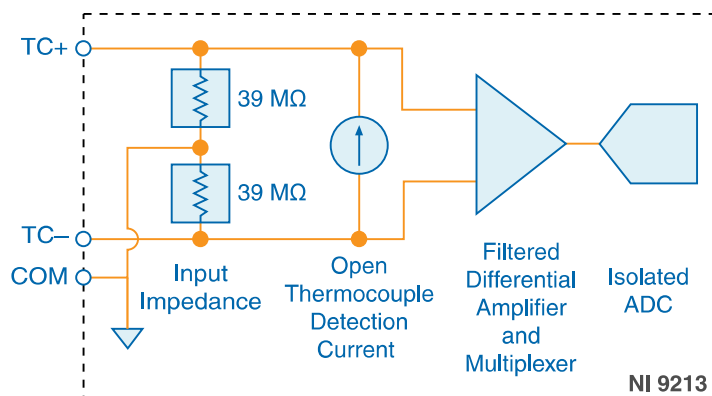

Common-Mode Voltage

The NI 9213 common-mode range is the maximum voltage between any channel and COM. If COM is not connected, then the common-mode voltage range is the maximum voltage between any two channels. The NI 9213 measures the common-mode voltage level of each channel and returns a warning in the software if the signal is outside the common-mode voltage range.

Open Thermocouple Detection

Each channel has an open thermocouple detection (OTD) circuit, which consists of a current source between the TC+ and TC- terminals. If an open thermocouple is connected to the channel, the current source forces a full-scale voltage across the terminals.

Input Impedance

Each channel has a resistor that produces an input impedance between the TC and COM terminals. The gain and offset errors resulting from the source impedance of connected thermocouples are negligible for most applications. Thermocouples with a higher lead resistance can introduce more significant errors.

Thermocouple Measurement Accuracy

Thermocouple measurement errors depend partly on the following factors:

- the type of thermocouple
- the accuracy of the thermocouple
- the temperature that you are measuring
- the resistance of the thermocouple wires
- the cold-junction temperature

For the best accuracy performance, follow these guidelines:

- Set up the NI 9213 according to the getting started guide on ni.com/manuals to minimize thermal gradients across the NI 9213 terminals.
- Use the autozero channel to compensate for offset errors.

Cold-Junction Accuracy

Heat dissipated by adjacent C Series modules or nearby heat sources can cause errors in thermocouple measurements by heating the NI 9213 terminals to a different temperature than the cold-junction compensation sensor. Thermal gradient across the terminals can cause the terminals of different NI 9213 channels to be at different temperatures, which creates accuracy errors and affects the relative accuracy between channels.

The temperature measurement accuracy specifications include errors caused by the thermal gradient across the NI 9213 terminals for configurations with the NI 9213 terminals facing forward or upward.

Autozero Channel

The NI 9213 has an internal autozero channel, which can be subtracted from each thermocouple reading to compensate for offset errors. Use of the autozero channel is optional, however the NI 9213 specifications assume that autozero is applied to every sample. Refer to the documentation for the software that you are using with the NI 9213 for information about using the autozero channel.

Timing Modes

The NI 9213 supports high-resolution and high-speed timing modes. High-resolution timing mode optimizes accuracy and noise and rejects power line frequencies. High-speed timing mode optimizes sample rate and signal bandwidth.

NI 9213 Specifications

The following specifications are typical for the range -40 °C to 70 °C unless otherwise noted.



Caution Do not operate the NI 9213 in a manner not specified in this document. Product misuse can result in a hazard. You can compromise the safety protection built into the product if the product is damaged in any way. If the product is damaged, return it to NI for repair.

Warm-up time	15 minutes
--------------	------------

Input Characteristics

Number of channels	16 thermocouple channels, 1 internal autozero channel, 1 internal cold-junction compensation channel
ADC resolution	24 bits
Type of ADC	Delta-Sigma
Sampling mode	Scanned
Voltage measurement range	±78.125 mV
Temperature measurement ranges	Works over temperature ranges defined by NIST (J, K, T, E, N, B, R, S thermocouple types)

Table 1. Timing Modes

Timing Mode	Conversion Time (Per Channel)	Sample Rate ¹ (All Channels ²)
High-resolution	55 ms	1 S/s
High-speed	740 µs	75 S/s

Common-mode voltage range

Channel-to-COM	±1.2 V minimum
COM-to-earth ground	±250 V

¹ If you are using fewer than all channels, the sample rate might be faster. The maximum sample rate = $1 / (\text{Conversion Time} \times \text{Number of Channels})$, or 100 S/s, whichever is smaller. Sampling faster than the maximum sample rate may result in the degradation of accuracy.

² Including the autozero and cold-junction channels.

Common-mode rejection ratio

High-resolution mode (at DC and 50 Hz to 60 Hz)	
Channel-to-COM	100 dB
COM-to-earth ground	>170 dB
High-speed mode (at 0 Hz to 60 Hz)	
Channel-to-COM	70 dB
COM-to-earth ground	>150 dB
Input bandwidth	
High-resolution mode	14.4 Hz
High-speed mode	78 Hz
High-resolution noise rejection (at 50 Hz and 60 Hz)	60 dB
Overvoltage protection	± 30 V between any two inputs
Differential input impedance	78 M Ω
Input current	50 nA
Input noise	
High-resolution mode	200 nV _{rms}
High-speed mode	7 μ V _{rms}
Gain error	
High-resolution mode	
at 25 °C	0.03% typical
at -40 °C to 70 °C	0.07% typical, 0.15% maximum
High-speed mode	
at 25 °C	0.04% typical
at -40 °C to 70 °C	0.08% typical, 0.16% maximum
Offset error	
High-resolution mode	4 μ V typical, 6 μ V maximum
High-speed mode	14 μ V typical, 17 μ V maximum
Offset error from source impedance	Add 0.05 μ V per Ω , when source impedance >50 Ω

Cold-junction compensation accuracy

0 °C to 70 °C	0.8 °C typical, 1.7 °C maximum
-40 °C to 70 °C	1.1 °C typical, 2.1 °C maximum
MTBF	852,407 hours at 25 °C; Bellcore Issue 2, Method 1, Case 3, Limited Part Stress Method

Temperature Measurement Accuracy

Measurement sensitivity³

High-resolution mode	
Types J, K, T, E, N	<0.02 °C
Types B, R, S	<0.15 °C
High-speed mode	
Types J, K, T, E	<0.25 °C
Type N	<0.35 °C
Type B	<1.2 °C
Types R, S	<2.8 °C

The following figures show the errors for each thermocouple type when connected to the NI 9213 with the autozero channel on. The figures display the maximum errors over a full temperature range and typical errors at room temperature. The figures account for gain errors, offset errors, differential and integral nonlinearity, quantization errors, noise errors, 50 Ω lead wire resistance, and cold-junction compensation errors. The figures do not account for the accuracy of the thermocouple itself.

³ Measurement sensitivity represents the smallest change in a temperature that a sensor can detect. It is a function of noise. The values assume the full measurement range of the standard thermocouple sensor according to ASTM E230-87.

Figure 2. Thermocouple Types J and N Errors

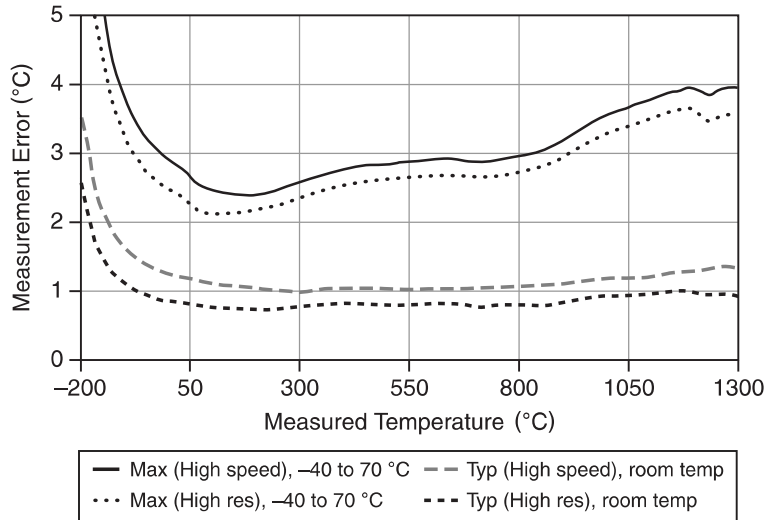

Figure 3. Thermocouple Type K Errors

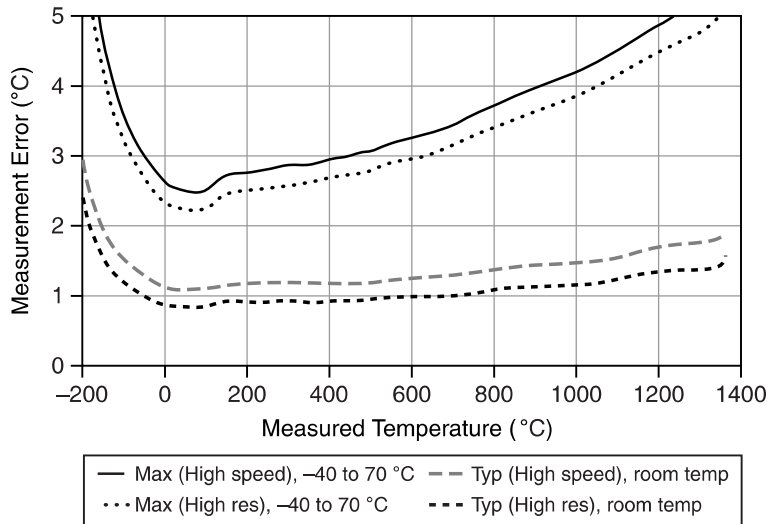

Figure 4. Thermocouple Types T and E Errors

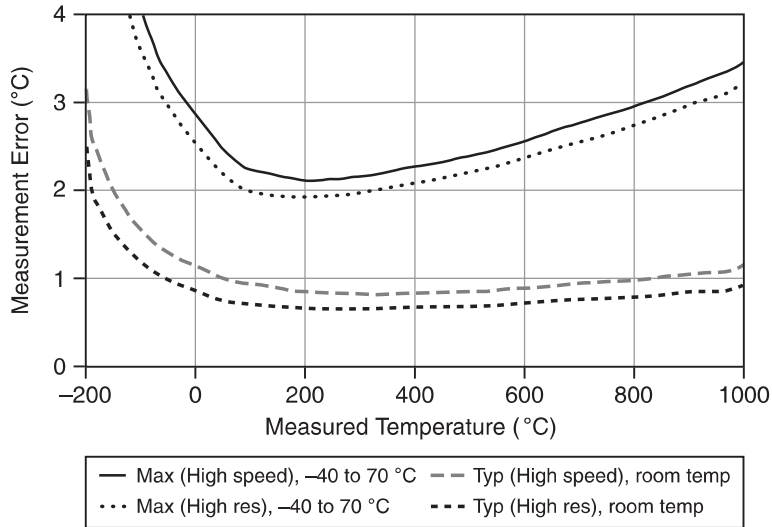

Figure 5. Thermocouple Type B Errors

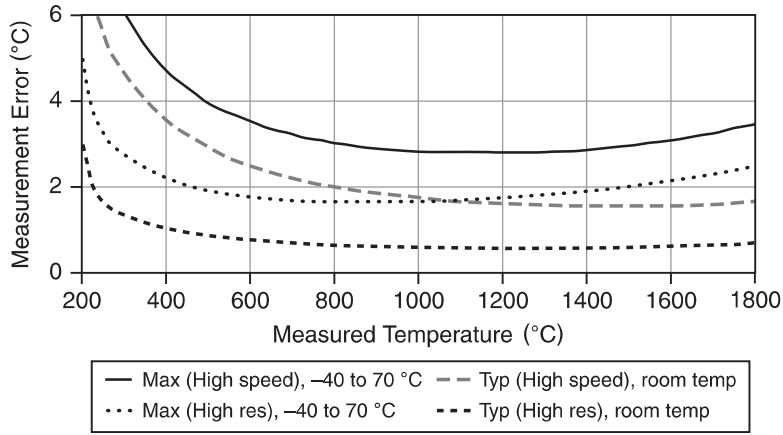
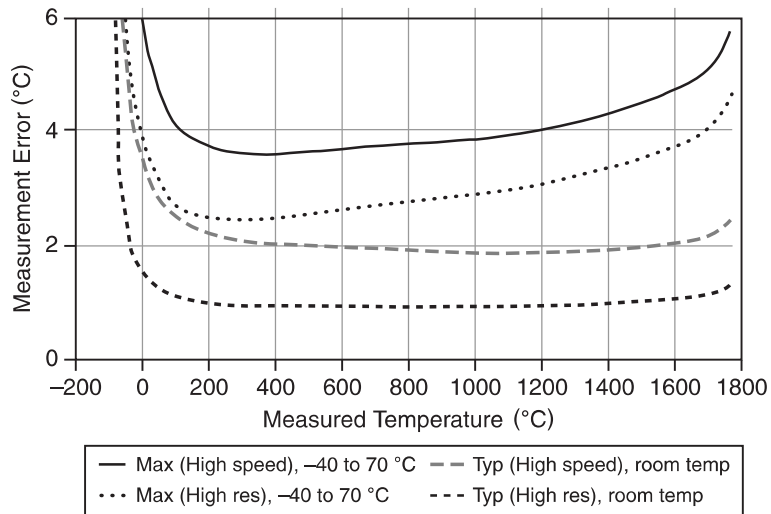

Figure 6. Thermocouple Types R and S Errors



Power Requirements

Power consumption from chassis	
Active mode	490 mW maximum
Sleep mode	25 μ W maximum
Thermal dissipation (at 70 °C)	
Active mode	840 mW maximum
Sleep mode	710 mW maximum

Physical Characteristics

If you need to clean the module, wipe it with a dry towel.



Tip For two-dimensional drawings and three-dimensional models of the C Series module and connectors, visit ni.com/dimensions and search by module number.

Spring-terminal wiring	
Gauge	0.08 mm ² to 1.0 mm ² (28 AWG to 18 AWG) copper conductor wire
Wire strip length	7 mm (0.28 in.) of insulation stripped from the end
Temperature rating	90 °C minimum
Wires per spring terminal	One wire per spring terminal
Connector securement	
Securement type	Screw flanges provided
Torque for screw flanges	0.2 N · m (1.80 lb · in.)
Weight	159 g (5.6 oz)

Safety Voltages

Connect only voltages that are within the following limits:

Between any two terminals	\pm 30 V maximum
Isolation	
Channel-to-channel	None
Channel-to-earth ground	
Continuous	250 Vrms, Measurement Category II
Withstand	2,300 Vrms, verified by a 5 s dielectric withstand test

Measurement Category II is for measurements performed on circuits directly connected to the electrical distribution system. This category refers to local-level electrical distribution, such as that provided by a standard wall outlet, for example, 115 V for U.S. or 230 V for Europe.



Caution Do not connect the NI 9213 to signals or use for measurements within Measurement Categories III or IV.

Hazardous Locations

U.S. (UL)	Class I, Division 2, Groups A, B, C, D, T4; Class I, Zone 2, AEx nA IIC T4
Canada (C-UL)	Class I, Division 2, Groups A, B, C, D, T4; Class I, Zone 2, Ex nA IIC T4
Europe (ATEX) and International (IECEX)	Ex nA IIC T4 Gc

Safety and Hazardous Locations Standards

This product is designed to meet the requirements of the following electrical equipment safety standards for measurement, control, and laboratory use:

- IEC 61010-1, EN 61010-1
- UL 61010-1, CSA 61010-1
- EN 60079-0:2012, EN 60079-15:2010
- IEC 60079-0: Ed 6, IEC 60079-15; Ed 4
- UL 60079-0; Ed 5, UL 60079-15; Ed 3
- CSA 60079-0:2011, CSA 60079-15:2012



Note For UL and other safety certifications, refer to the product label or the [Online Product Certification](#) section.

Electromagnetic Compatibility

This product meets the requirements of the following EMC standards for sensitive electrical equipment for measurement, control, and laboratory use:

- EN 61326 (IEC 61326): Class A emissions; Industrial immunity
- EN 55011 (CISPR 11): Group 1, Class A emissions
- AS/NZS CISPR 11: Group 1, Class A emissions
- FCC 47 CFR Part 15B: Class A emissions
- ICES-001: Class A emissions



Note For the standards applied to assess the EMC of this product, refer to the [Online Product Certification](#) section.



Note For EMC compliance, operate this device with double-shielded cables.

CE Compliance

This product meets the essential requirements of applicable European Directives, as follows:

- 2014/35/EU; Low-Voltage Directive (safety)
- 2014/30/EU; Electromagnetic Compatibility Directive (EMC)
- 94/9/EC; Potentially Explosive Atmospheres (ATEX)

Online Product Certification

Refer to the product Declaration of Conformity (DoC) for additional regulatory compliance information. To obtain product certifications and the DoC for this product, visit ni.com/certification, search by model number or product line, and click the appropriate link in the Certification column.

Shock and Vibration

To meet these specifications, you must panel mount the system.

Operating vibration	
Random (IEC 60068-2-64)	5 g _{rms} , 10 Hz to 500 Hz
Sinusoidal (IEC 60068-2-6)	5 g, 10 Hz to 500 Hz
Operating shock (IEC 60068-2-27)	30 g, 11 ms half sine; 50 g, 3 ms half sine; 18 shocks at 6 orientations

Environmental

Refer to the manual for the chassis you are using for more information about meeting these specifications.

Operating temperature (IEC 60068-2-1, IEC 60068-2-2)	-40 °C to 70 °C
Storage temperature (IEC 60068-2-1, IEC 60068-2-2)	-40 °C to 85 °C
Ingress protection	IP40
Operating humidity (IEC 60068-2-78)	10% RH to 90% RH, noncondensing
Storage humidity (IEC 60068-2-78)	5% RH to 95% RH, noncondensing
Pollution Degree	2
Maximum altitude	2,000 m

Indoor use only.

Environmental Management

NI is committed to designing and manufacturing products in an environmentally responsible manner. NI recognizes that eliminating certain hazardous substances from our products is beneficial to the environment and to NI customers.

For additional environmental information, refer to the *Minimize Our Environmental Impact* web page at ni.com/environment. This page contains the environmental regulations and directives with which NI complies, as well as other environmental information not included in this document.

Waste Electrical and Electronic Equipment (WEEE)



EU Customers At the end of the product life cycle, all NI products must be disposed of according to local laws and regulations. For more information about how to recycle NI products in your region, visit ni.com/environment/weee.

电子信息产品污染控制管理办法（中国 RoHS）



中国客户 National Instruments 符合中国电子信息产品中限制使用某些有害物质指令 (RoHS)。关于 National Instruments 中国 RoHS 合规性信息，请登录 ni.com/environment/rohs_china。(For information about China RoHS compliance, go to ni.com/environment/rohs_china.)

Calibration

You can obtain the calibration certificate and information about calibration services for the NI 9213 at ni.com/calibration.

Calibration interval	1 year
----------------------	--------

Refer to the *NI Trademarks and Logo Guidelines* at ni.com/trademarks for information on NI trademarks. Other product and company names mentioned herein are trademarks or trade names of their respective companies. For patents covering NI products/technology, refer to the appropriate location: **Help»Patents** in your software, the `patents.txt` file on your media, or the *National Instruments Patent Notice* at ni.com/patents. You can find information about end-user license agreements (EULAs) and third-party legal notices in the readme file for your NI product. Refer to the *Export Compliance Information* at ni.com/legal/export-compliance for the NI global trade compliance policy and how to obtain relevant HTS codes, ECCNs, and other import/export data. NI MAKES NO EXPRESS OR IMPLIED WARRANTIES AS TO THE ACCURACY OF THE INFORMATION CONTAINED HEREIN AND SHALL NOT BE LIABLE FOR ANY ERRORS. U.S. Government Customers: The data contained in this manual was developed at private expense and is subject to the applicable limited rights and restricted data rights as set forth in FAR 52.227-14, DFAR 252.227-7014, and DFAR 252.227-7015.

© 2016 National Instruments. All rights reserved.

374916A-02 Jan16

cRIO-9940

Dimensional Drawing



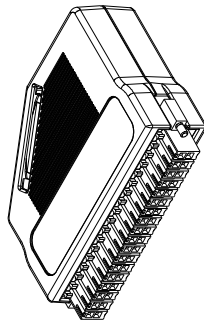

ISOMETRIC VIEW WITH 36 PIN CONNECTOR

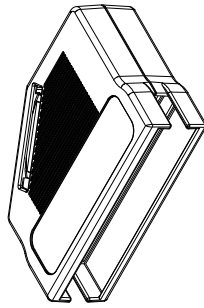
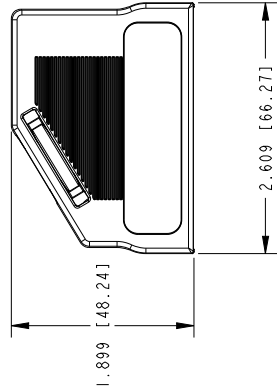
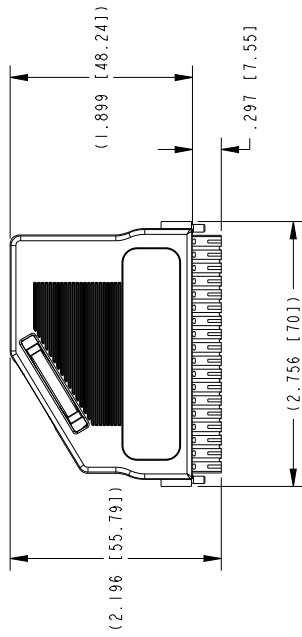

ISOMETRIC VIEW BACKSHELL ONLY

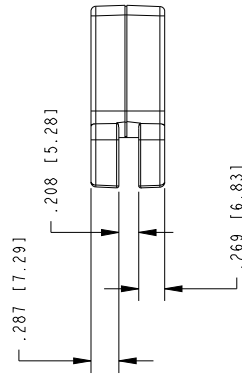
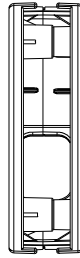
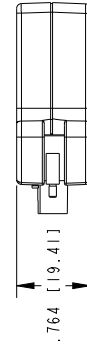
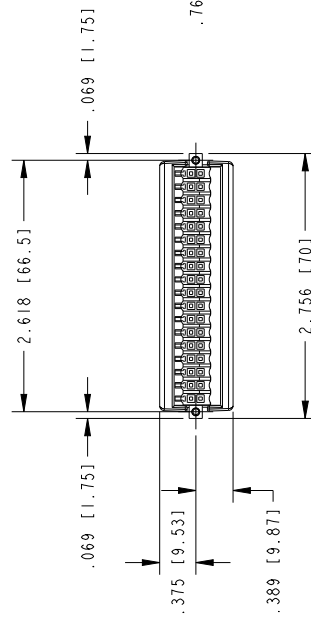
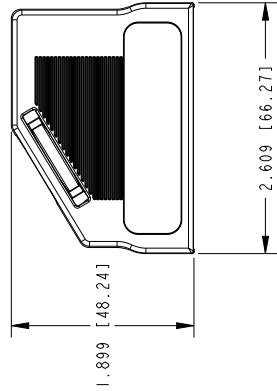

2. DIMENSIONS IN () ARE FOR REFERENCE ONLY.
 1. REFER TO PRODUCT MANUAL ON NI.COM FOR MORE DETAILS
 NOTES: UNLESS OTHERWISE SPECIFIED.

CUSTOMER DRAWING

UNLESS OTHERWISE SPECIFIED, DIMENSIONS ARE IN INCHES AND (MILLIMETERS).

DO NOT SCALE DRAWING

THIRD ANGLE PROJECTION

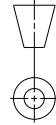

AUSTIN, TEXAS

NI 9940
 36 PIN WEIDMULLER
 CONNECTOR BLOCK

SIZE CODE IDENT NO: IMM/DD/YYYY

C7U296 03/11/2016

SCALE: 1/1/1

SHEET 1 OF 1

CU-NI-9940