



cDAQ-T1100

CompactDAQ Temperature Measurement Bundle

Datasheet and Specifications

cDAQ-9171 and NI-9210

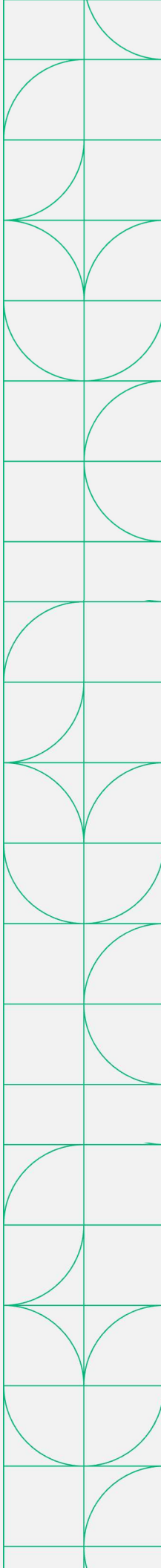

CompactDAQ Temperature Measurement Bundle

In-Box Components

cDAQ-T1100 Bundle System P/N: 865662-01



NI-9210
(Thermocouple Module)



cDAQ-9171
(1-Slot CompactDAQ Chassis)



USB Cable
(USB-A to USB-B)

Recommended Software

FlexLogger



P/N: 785748-3501

No code software that accelerates measurement configuration and logging with NI DAQ Hardware.

- Acquire data and log test results to .tdms or .csv files
- Inline calculations for simple math, filtering, Boolean logic, and more
- Integrated TDMS Viewer for interactive data review

Table of Contents

This document combines the PDFs of this system together. The page numbers in the table of contents correspond to the page number of PDF the component's documentation begins.

cDAQ-9171 Specifications.....	3
NI-9210 Specifications.....	13

cDAQ-9171 Specifications



DEVICE SPECIFICATIONS

NI cDAQ™ -9171

NI CompactDAQ One-Slot Bus-Powered USB Chassis

These specifications are for the NI cDAQ-9171 chassis only. These specifications are typical at 25 °C unless otherwise noted. For the C Series module specifications, refer to the documentation for the C Series module you are using.

Analog Input

Input FIFO size	127 samples
Maximum sample rate ¹	Determined by the C Series module
Timing accuracy ²	50 ppm of sample rate
Timing resolution ²	12.5 ns
Number of channels supported	Determined by the C Series module

Analog Output

Number of channels supported	
Hardware-timed task	
Onboard regeneration	16
Non-regeneration	Determined by the C Series module
Non-hardware-timed task	Determined by the C Series module
Maximum update rate	
Onboard regeneration	1.6 MS/s (multi-channel, aggregate)
Non-regeneration	Determined by the C Series module

¹ Performance dependent on type of installed C Series module and number of channels in the task.

² Does not include group delay. For more information, refer to the documentation for each C Series module.

Timing accuracy	50 ppm of sample rate
Timing resolution	12.5 ns
Output FIFO size	
Onboard regeneration	8,191 samples shared among channels used
Non-regeneration	127 samples
AO waveform modes	Non-periodic waveform, periodic waveform regeneration mode from onboard memory, periodic waveform regeneration from host buffer including dynamic update

Digital Waveform Characteristics

Waveform acquisition (DI) FIFO	
Parallel modules	511 samples
Serial modules	63 samples
Waveform generation (DO) FIFO	
Parallel modules	2,047 samples
Serial modules	63 samples
Digital input sample clock frequency	
Streaming to application memory	System-dependent
Finite	0 MHz to 10 MHz
Digital output sample clock frequency	
Streaming from application memory	System-dependent
Regeneration from FIFO	0 MHz to 10 MHz
Finite	0 MHz to 10 MHz
Timing accuracy	50 ppm

General-Purpose Counters/Timers

Number of counters/timers	4
Resolution	32 bits
Counter measurements	Edge counting, pulse, semi-period, period, two-edge separation, pulse width
Position measurements	X1, X2, X4 quadrature encoding with Channel Z reloading; two-pulse encoding

Output applications	Pulse, pulse train with dynamic updates, frequency division, equivalent time sampling
Internal base clocks	80 MHz, 20 MHz, 100 kHz
External base clock frequency	0 MHz to 20 MHz
Base clock accuracy	50 ppm
Output frequency	0 MHz to 20 MHz
Inputs	Gate, Source, HW_Arm, Aux, A, B, Z, Up_Down
Routing options for inputs	Any module PFI, analog trigger, many internal signals
FIFO	Dedicated 127-sample FIFO

Frequency Generator

Number of channels	1
Base clocks	20 MHz, 10 MHz, 100 kHz
Divisors	1 to 16 (integers)
Base clock accuracy	50 ppm
Output	Any module PFI terminal

Module PFI Characteristics

Functionality	Static digital input, static digital output, timing input, and timing output
Timing output sources ³	Many analog input, analog output, counter, digital input, and digital output timing signals
Timing input frequency	0 MHz to 20 MHz
Timing output frequency	0 MHz to 20 MHz

Digital Triggers

Source	Any module PFI terminal
Polarity	Software-selectable for most signals

³ Actual available signals are dependent on type of installed C Series module.

Analog input function	Start Trigger, Reference Trigger, Pause Trigger, Sample Clock, Sample Clock Timebase
Analog output function	Start Trigger, Pause Trigger, Sample Clock, Sample Clock Timebase
Counter/timer function	Gate, Source, HW_Arm, Aux, A, B, Z, Up_Down

Module I/O States

At power-on	Module-dependent. Refer to the documentation for each C Series module.
-------------	--



Note The NI cDAQ-9171 may revert the input/output of the modules to their power-on state when the USB cable is removed.

Bus Interface

USB specification	USB 2.0 Hi-Speed
High-performance data streams	6
Data stream types available	Analog input, analog output, digital input, digital output, counter/timer input, counter/timer output, NI-XNET ⁴



Note If you are connecting the NI cDAQ-9171 to a USB hub, the hub must be externally powered.

Power Requirements



Caution The protection provided by the NI cDAQ-9171 chassis can be impaired if it is used in a manner not described in this document.



Note Some C Series modules have additional power requirements. For more information about C Series module power requirements, refer to the documentation for each C Series module.

⁴ When a session is active, CAN or LIN (NI-XNET) C Series modules use a total of two data streams regardless of the number of NI-XNET modules in the chassis.



Note Sleep mode for C Series modules is not supported in the NI cDAQ-9171.

Power consumption from USB	5 V, 500 mA maximum
Suspend mode	2.5 mA maximum

Physical Characteristics

Weight (unloaded)	353 g (12.5 oz)
Dimensions (unloaded)	131.4 mm × 88.6 mm × 33.3 mm (5.17 in. × 3.49 in. × 1.31 in.) Refer to the following figure.
USB connector securement	
USB securement type	Jackscrew provided on locking USB cable (part number 198506-01 or 780534-01)
Torque for jackscrew	0.41 N · m (3.6 lb · in.)
Chassis ground	
Gauge	1.31 mm ² (16 AWG) or larger wire
Torque for ground screw	0.76 N · m (6.7 lb · in.)

If you need to clean the chassis, wipe it with a dry towel.

Figure 1. NI cDAQ-9171 Dimensions

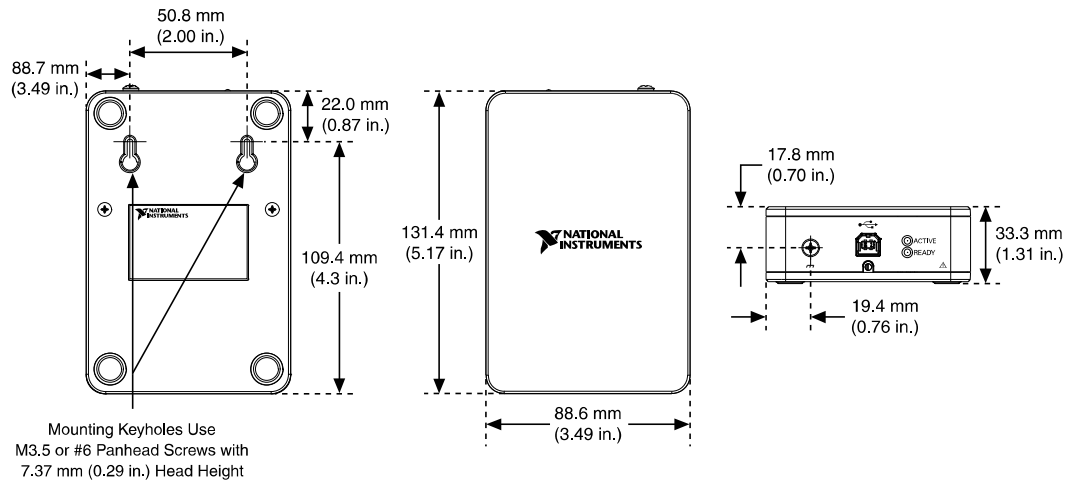

Environmental

Operating temperature (IEC-60068-2-1 and IEC-60068-2-2)	-20 °C to 55 °C
Storage temperature (IEC-600068-2-1 and IEC-60068-2-2)	-40 °C to 85 °C
Operating humidity (IEC-60068-2-56)	10% to 90% RH, noncondensing
Storage humidity (IEC-60068-2-56)	5% to 95% RH, noncondensing
Pollution Degree (IEC 60664)	2
Maximum altitude	5,000 m

Indoor use only.

Hazardous Locations

U.S. (UL)	Class I, Division 2, Groups A, B, C, D, T4; Class I, Zone 2, AEx nA IIC T4
Canada (C-UL)	Class I, Division 2, Groups A, B, C, D, T4; Class I, Zone 2, Ex nA IIC T4
Europe (ATEX) and International (IECEX)	Ex nA IIC T4 Gc

Shock and Vibration

To meet these specifications, you must panel mount the NI cDAQ-9171 system, use an NI locking USB cable, and affix ferrules to the ends of the terminal lines.

Operational shock	30 g peak, half-sine, 11 ms pulse (Tested in accordance with IEC 60068-2-27. Test profile developed in accordance with MIL-PRF-28800F.)
Random vibration	
Operating	5 Hz to 500 Hz, 0.3 g _{rms}
Non-operating	5 Hz to 500 Hz, 2.4 g _{rms} (Tested in accordance with IEC 60068-2-64. Non-operating test profile exceeds the requirements of MIL PRF-28800F, Class 3.)

Safety and Hazardous Locations Standards

This product is designed to meet the requirements of the following electrical equipment safety standards for measurement, control, and laboratory use:

- IEC 61010-1, EN 61010-1
- UL 61010-1, CSA 61010-1
- EN 60079-0:2012, EN 60079-15:2010
- IEC 60079-0: Ed 6, IEC 60079-15; Ed 4
- UL 60079-0; Ed 6, UL 60079-15; Ed 4
- CSA 60079-0:2011, CSA 60079-15:2012



Note For UL and other safety certifications, refer to the product label or the [Online Product Certification](#) section.

Electromagnetic Compatibility

This product meets the requirements of the following EMC standards for electrical equipment for measurement, control, and laboratory use:

- EN 61326-1 (IEC 61326-1): Class A emissions; Basic immunity
- EN 55011 (CISPR 11): Group 1, Class A emissions
- EN 55022 (CISPR 22): Class A emissions
- EN 55024 (CISPR 24): Immunity
- AS/NZS CISPR 11: Group 1, Class A emissions
- AS/NZS CISPR 22: Class A emissions
- FCC 47 CFR Part 15B: Class A emissions
- ICES-001: Class A emissions



Note In the United States (per FCC 47 CFR), Class A equipment is intended for use in commercial, light-industrial, and heavy-industrial locations. In Europe, Canada, Australia and New Zealand (per CISPR 11) Class A equipment is intended for use only in heavy-industrial locations.



Note Group 1 equipment (per CISPR 11) is any industrial, scientific, or medical equipment that does not intentionally generate radio frequency energy for the treatment of material or inspection/analysis purposes.



Note For EMC declarations and certifications, and additional information, refer to the [Online Product Certification](#) section.

CE Compliance

This product meets the essential requirements of applicable European Directives, as follows:

- 2014/35/EU; Low-Voltage Directive (safety)
- 2014/30/EU; Electromagnetic Compatibility Directive (EMC)
- 2014/34/EU; Potentially Explosive Atmospheres (ATEX)

Online Product Certification

Refer to the product Declaration of Conformity (DoC) for additional regulatory compliance information. To obtain product certifications and the DoC for this product, visit ni.com/certification, search by model number or product line, and click the appropriate link in the Certification column.

Environmental Management

NI is committed to designing and manufacturing products in an environmentally responsible manner. NI recognizes that eliminating certain hazardous substances from our products is beneficial to the environment and to NI customers.

For additional environmental information, refer to the *Minimize Our Environmental Impact* web page at ni.com/environment. This page contains the environmental regulations and directives with which NI complies, as well as other environmental information not included in this document.

Waste Electrical and Electronic Equipment (WEEE)



EU Customers At the end of the product life cycle, all NI products must be disposed of according to local laws and regulations. For more information about how to recycle NI products in your region, visit ni.com/environment/weee.

电子信息产品污染控制管理办法（中国 RoHS）



中国客户 National Instruments 符合中国电子信息产品中限制使用某些有害物质指令 (RoHS)。关于 National Instruments 中国 RoHS 合规性信息，请登录 ni.com/environment/rohs_china。(For information about China RoHS compliance, go to ni.com/environment/rohs_china.)

Refer to the *NI Trademarks and Logo Guidelines* at ni.com/trademarks for information on NI trademarks. Other product and company names mentioned herein are trademarks or trade names of their respective companies. For patents covering NI products/technology, refer to the appropriate location: **Help»Patents** in your software, the `patents.txt` file on your media, or the *National Instruments Patent Notice* at ni.com/patents. You can find information about end-user license agreements (EULAs) and third-party legal notices in the readme file for your NI product. Refer to the *Export Compliance Information* at ni.com/legal/export-compliance for the NI global trade compliance policy and how to obtain relevant HTS codes, ECCNs, and other import/export data. NI MAKES NO EXPRESS OR IMPLIED WARRANTIES AS TO THE ACCURACY OF THE INFORMATION CONTAINED HEREIN AND SHALL NOT BE LIABLE FOR ANY ERRORS. U.S. Government Customers: The data contained in this manual was developed at private expense and is subject to the applicable limited rights and restricted data rights as set forth in FAR 52.227-14, DFAR 252.227-7014, and DFAR 252.227-7015.

© 2013—2016 National Instruments. All rights reserved.

NI-9210

DataSheet



DATASHEET

NI 9210

4-Channel, 14 S/s Aggregate, ± 80 mV C Series Temperature Input Module





- Mini-TC or spring terminal connectivity
- 50 Hz/60 Hz noise rejection
- 60 V DC, CAT I, channel-to-earth isolation (mini-TC); 250 V RMS, CAT II, channel-to-earth isolation (spring terminal)



Note In this document, the NI 9210 with mini-TC and the NI 9210 with spring terminal are referred to inclusively as the NI 9210.

The NI 9210 includes anti-aliasing filters, open-thermocouple detection, and cold-junction compensation for high-accuracy thermocouple measurements. The NI 9210 features NIST-traceable calibration and a channel-to-earth ground isolation barrier for safety, noise immunity, and high common-mode voltage range.

	Kit Contents	<ul style="list-style-type: none">• NI 9210• NI 9210 Getting Started Guide
	Accessories	<ul style="list-style-type: none">• Thermocouple Connectors

C Series Thermocouple Module Comparison

Product	Channels	Connectivity	Accuracy ¹	Max Sample Rate, Scanned ²	Max Sample Rate, Simultaneous ³	Max Sample Rate, All Filtered ⁴	OTD ⁵	Isolation ⁶
NI 9210	4	Screw Terminal	0.8°C	14 S/s	–	2.3 Scans/s	Yes	Ch-Earth
		Mini-TC	0.84°C					
NI 9211	4	Screw Terminal	0.9°C	14 S/s	–	2.3 Scans/s	Yes	Ch-Earth
NI 9212	8	Screw Terminal	0.4°C	–	95 S/s/Ch	7.1 Scans/s	Yes	Ch-Ch
		Mini-TC	0.7°C					
NI 9213	16	Spring Terminal†	0.8°C	100 S/s	–	1.0 Scans/s	Yes	Ch-Earth
NI 9214	16	Screw Terminal	0.4°C	100 S/s	–	0.96 Scans/s	Selectable	Ch-Earth
NI 9219	4	Spring Terminal	1.6°C	–	50 S/s/Ch	7.1 Scans/s	No	Ch-Ch

¹ Typical at 23±5°C operating temperature, For J-type sensor measuring 100°C.

² This is the fastest rate of the module for a single channel. When scanning more than one channel, the sample rate is reduced, see data sheets for details.

³ This is the fastest rate of the module; it can sample all channels simultaneously at this rate.

⁴ This is the fastest rate of the module using all of its channels at the same time, with optimized rejection of standard power line frequencies. See data sheets for details about specific powerline frequencies.

⁵ Open Thermocouple Detection.

⁶ Ch-Ch isolation means that the channels are isolated from earth ground and from each other. Ch-Earth isolation means that the channels are isolated from earth ground but not from each other.

† These connectors feature tool-less wire entry, meaning that solid core wires (AWG 26 - AWG 16) can be inserted without using a tool.

C Series Millivolt-Capable Module Comparison						
Product Name	Differential Channels	Connectivity	Accuracy ¹	Max Sample Rate, Scanned ²	Max Sample Rate, Simultaneous ³	Isolation ⁴
NI 9210	4	Screw Terminal	20 μ V + 0.1%	14 S/s	–	Ch-Earth
		Mini-TC				
NI 9211	4	Screw Terminal	20 μ V + 0.1%	14 S/s	–	Ch-Earth
NI 9212	8	Screw Terminal	14 μ V + 0.12%	–	95 S/s/Ch	Ch-Ch
		Mini-TC				
NI 9213	16	Spring Terminal†	6 μ V + 0.15%	100 S/s	–	Ch-Earth
NI 9214	16	Screw Terminal	8 μ V + 0.15%	100 S/s	–	Ch-Earth
NI 9219	4	Spring Terminal	90 μ V + 0.18%	–	50 S/s/Ch	Ch-Ch
NI 9205	16	DSUB	185 μ V + 0.06%‡	250 kS/s	–	Ch-Earth
		Spring Terminal				
NI 9206	16	Spring Terminal	185 μ V + 0.06%‡	250 kS/s	–	Ch-Earth
NI 9218	2	Lemo 1B	130 μ V + 0.2%	–	51.2 kS/s/Ch	Ch-Ch
		DSUB				
NI 9238	4	Screw Terminal	300 μ V + 0.2%	–	50 kS/s/Ch	Ch-Ch

¹ Maximum over full operating temperature range of –40 to +70°C.

² This is the fastest rate of the module for a single channel. When scanning more than one channel, the sample rate is reduced, see data sheets for details.

³ This is the fastest rate of the module; it can sample all channels simultaneously at this rate.

⁴ Ch-Ch isolation means that the channels are isolated from earth ground and from each other. Ch-Earth isolation means that the channels are isolated from earth ground but not from each other.

† These connectors feature tool-less wire entry, meaning that solid core wires (AWG 26 - AWG 16) can be inserted without using a tool.

‡ Within $\pm 5^\circ$ of the last internal calibration.

NI C Series Overview



NI provides more than 100 C Series modules for measurement, control, and communication applications. C Series modules can connect to any sensor or bus and allow for high-accuracy measurements that meet the demands of advanced data acquisition and control applications.

- Measurement-specific signal conditioning that connects to an array of sensors and signals
- Isolation options such as bank-to-bank, channel-to-channel, and channel-to-earth ground
- -40 °C to 70 °C temperature range to meet a variety of application and environmental needs
- Hot-swappable

The majority of C Series modules are supported in both CompactRIO and CompactDAQ platforms and you can move modules from one platform to the other with no modification.

CompactRIO



CompactRIO combines an open-embedded architecture with small size, extreme ruggedness, and C Series modules in a platform powered by the NI LabVIEW reconfigurable I/O (RIO) architecture. Each system contains an FPGA for custom timing, triggering, and processing with a wide array of available modular I/O to meet any embedded application requirement.

CompactDAQ

CompactDAQ is a portable, rugged data acquisition platform that integrates connectivity, data acquisition, and signal conditioning into modular I/O for directly interfacing to any sensor or signal. Using CompactDAQ with LabVIEW, you can easily customize how you acquire, analyze, visualize, and manage your measurement data.



Software

LabVIEW Professional Development System for Windows

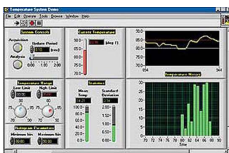

- Use advanced software tools for large project development
- Generate code automatically using DAQ Assistant and Instrument I/O Assistant
- Use advanced measurement analysis and digital signal processing
- Take advantage of open connectivity with DLLs, ActiveX, and .NET objects
- Build DLLs, executables, and MSI installers

NI LabVIEW FPGA Module

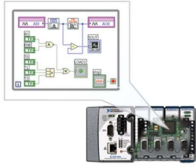

- Design FPGA applications for NI RIO hardware
- Program with the same graphical environment used for desktop and real-time applications
- Execute control algorithms with loop rates up to 300 MHz
- Implement custom timing and triggering logic, digital protocols, and DSP algorithms
- Incorporate existing HDL code and third-party IP including Xilinx IP generator functions
- Purchase as part of the LabVIEW Embedded Control and Monitoring Suite

NI LabVIEW Real-Time Module

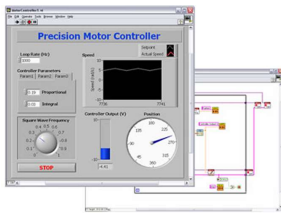

- Design deterministic real-time applications with LabVIEW graphical programming
- Download to dedicated NI or third-party hardware for reliable execution and a wide selection of I/O
- Take advantage of built-in PID control, signal processing, and analysis functions
- Automatically take advantage of multicore CPUs or set processor affinity manually
- Take advantage of real-time OS, development and debugging support, and board support
- Purchase individually or as part of a LabVIEW suite

Circuitry

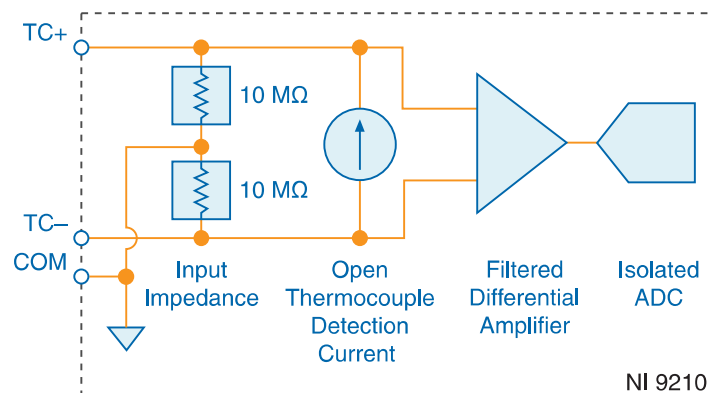

The channels of the NI 9210 share a common ground isolated from other modules in the system. Each channel passes through a filter and then a 24-bit analog-to-digital converter (ADC) samples the channel.

Open Thermocouple Detection

Each channel has an open thermocouple detection (OTD) circuit, which consists of a current source between the TC+ and TC- terminals. If an open thermocouple is connected to the channel, the current source forces a full-scale voltage across the terminals.

Input Impedance

Each channel has a resistor that produces an input impedance between the TC and COM terminals. The gain and offset errors resulting from the source impedance of connected thermocouples are negligible for most applications. Thermocouples with a higher lead resistance can introduce more significant errors.

Thermocouple Measurement Accuracy

Thermocouple measurement errors depend partly on the following factors:

- Type of thermocouple
- Accuracy of the thermocouple
- Temperature that you are measuring
- Resistance of the thermocouple wires
- Cold-junction temperature

For the best accuracy performance, set up the NI 9210 according to the getting started guide on ni.com/manuals to minimize thermal gradients across the NI 9210 terminals.

Cold-Junction Accuracy

Heat dissipated by adjacent C Series modules or nearby heat sources can cause errors in thermocouple measurements by heating the NI 9210 terminals to a different temperature than the cold-junction compensation sensor. Thermal gradient across the terminals can cause the terminals of different NI 9210 channels to be at different temperatures, which creates accuracy errors and affects the relative accuracy between channels.

The temperature measurement accuracy specifications include errors caused by the thermal gradient across the NI 9210 terminals for configurations with the NI 9210 terminals facing forward or upward.

Autozero Channel

The NI 9210 has an internal autozero channel, which can be subtracted from each thermocouple reading to compensate for offset errors. Use the autozero channel if the ambient temperature is less than 15 °C or more than 35 °C. Refer to the documentation for the software that you are using for information about using the NI 9210 autozero channel.

NI 9210 Specifications

The following specifications are typical for the range -40 °C to 70 °C unless otherwise noted.



Caution Do not operate the NI 9210 in a manner not specified in this document. Product misuse can result in a hazard. You can compromise the safety protection built into the product if the product is damaged in any way. If the product is damaged, return it to NI for repair.

Input Characteristics

Number of channels	4 thermocouple channels, 1 internal autozero channel, 1 internal cold-junction compensation channel
ADC resolution	24 bits
Type of ADC	Delta-Sigma
Sampling mode	Scanned
Voltage measurement range	± 80 mV
Temperature measurement ranges	Works over temperature ranges defined by NIST (J, K, T, E, N, B, R, S thermocouple types)
Conversion time	70 ms per channel; 420 ms total for all channels including the autozero and cold-junction channels
Common-mode voltage range	
Channel-to-COM	± 1.5 V
COM-to-earth ground	
NI 9210 with mini-TC	60 V RMS
NI 9210 with spring terminal	250 V RMS
Common-mode rejection ratio (0 Hz to 60 Hz)	
Channel-to-COM	95 dB
COM-to-earth ground	>170 dB
Input bandwidth (-3 dB)	15 Hz
Noise rejection (at 50 Hz and 60 Hz)	85 dB minimum
Overvoltage protection	
Between any input and COM	± 30 V
Between any two inputs	± 30 V
Differential input impedance	20 M Ω
Input current	50 nA
Input noise	1 μ V RMS

Gain error (at -40 °C to 70 °C)	0.06% typical 0.1% maximum
Offset error (with autozero channel on)	±15 µV typical ±20 µV maximum
Gain error from source impedance	Add 0.05 ppm per Ω when source impedance >50 Ω
Offset error from source impedance	Add ±0.05 µV typical, ±0.07 µV maximum per Ω when source impedance >50 Ω
Cold-junction compensation sensor accuracy	
NI 9210 with mini-TC	
23 °C, ±5 °C	0.35 °C typical
-40 °C to 70 °C	0.55 °C typical 0.95 °C maximum
NI 9210 with spring terminal	
23 °C ± 5 °C	0.55 °C typical
-40 °C to 70 °C	0.75 °C typical 1.5 °C maximum

Temperature Measurement Accuracy



Caution The input terminals of this device are not protected from electromagnetic interference. As a result, this device may experience reduced measurement accuracy or other temporary performance degradation when connected cables are routed in an environment with radiated or conducted radio frequency electromagnetic interference. To limit radiated emissions and to ensure that this device functions within specifications in its operational electromagnetic environment, take precautions when designing, selecting, and installing measurement probes and cables.

Measurement sensitivity¹

With autozero channel on	
Types J, K, T, E, N	<0.07 °C
Type B	<0.25 °C
Types R, S	<0.60 °C

¹ Measurement sensitivity represents the smallest change in temperature that a sensor can detect. It is a function of noise. The values assume the full measurement range of the standard thermocouple sensor according to ASTM E230-87.

With autozero channel off

Types J, K, T, E, N	<0.05 °C
Type B	<0.20 °C
Types R, S	<0.45 °C

The following figures show the typical and maximum errors for each thermocouple type when used with the NI 9210 over the full temperature range and autozero on as well as the typical errors at 23 °C, ±5 °C without autozero. The figures account for gain errors, offset errors, differential and integral nonlinearity, quantization errors, noise errors, and isothermal errors. The figures do not account for the accuracy of the thermocouple itself.

Figure 1. NI 9210 with Mini-TC Thermocouple Type J and N Errors

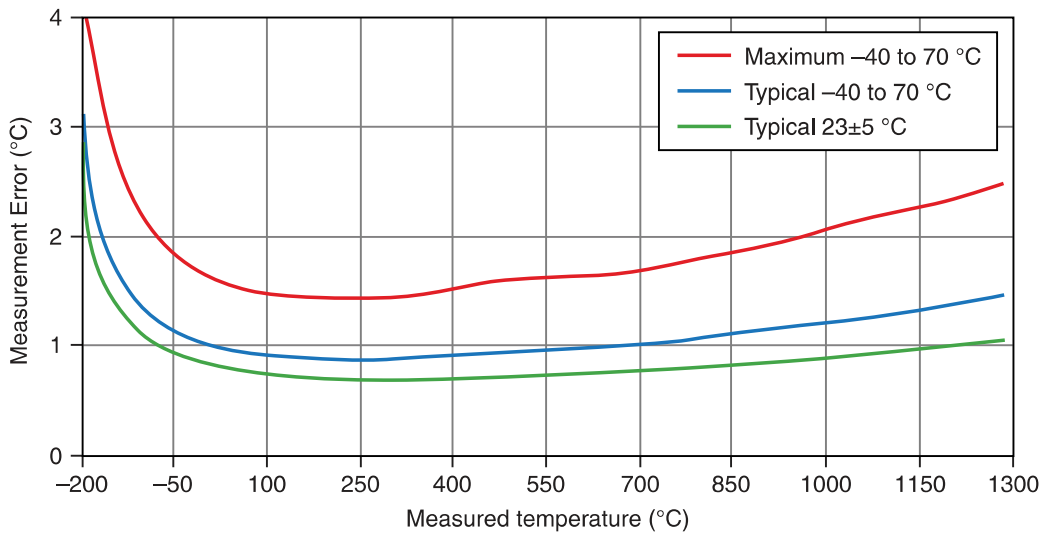

Figure 2. NI 9210 with Spring Terminal Thermocouple Type J and N Errors

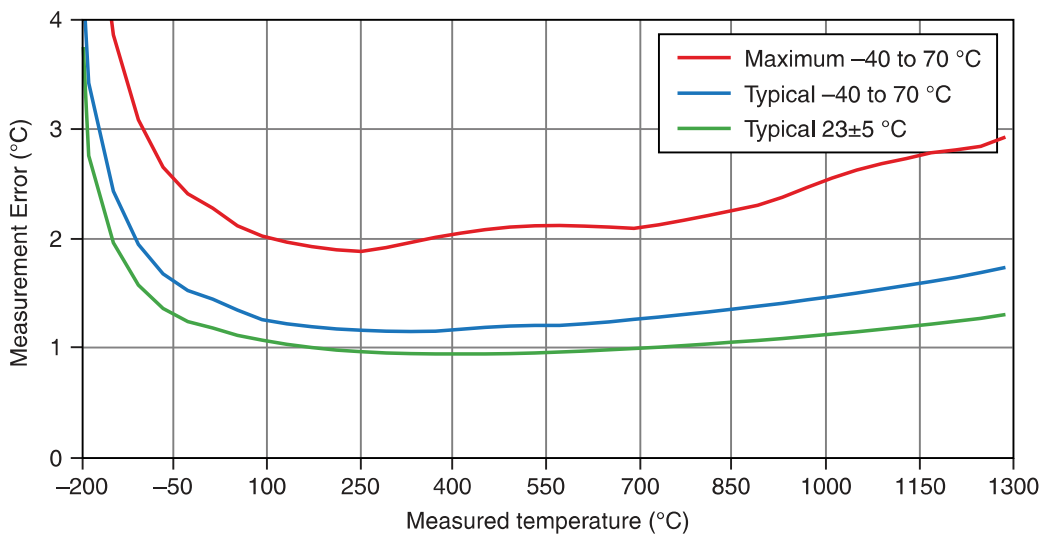

Figure 3. NI 9210 with Mini-TC Thermocouple Type K Errors

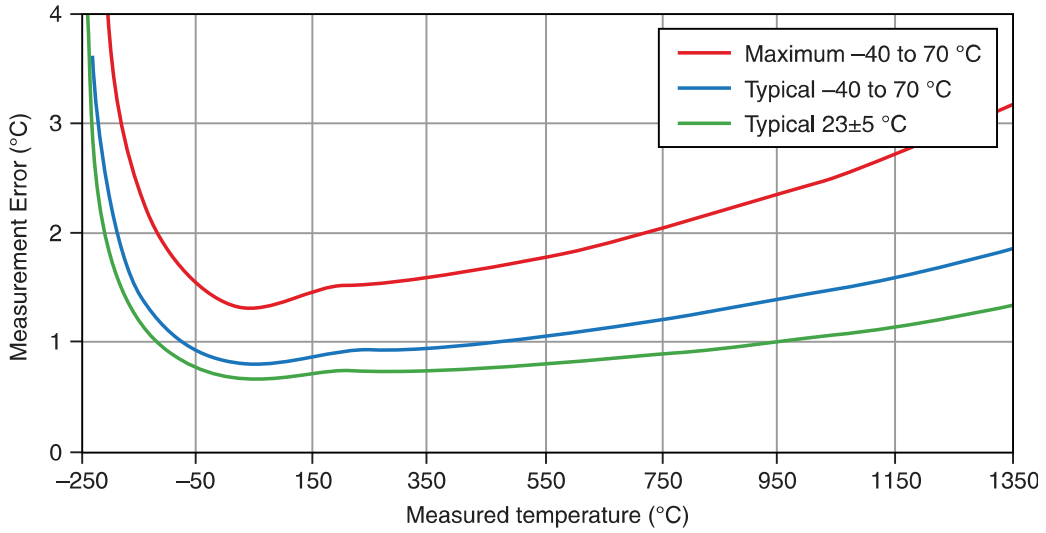

Figure 4. NI 9210 with Spring Terminal Thermocouple Type K Errors

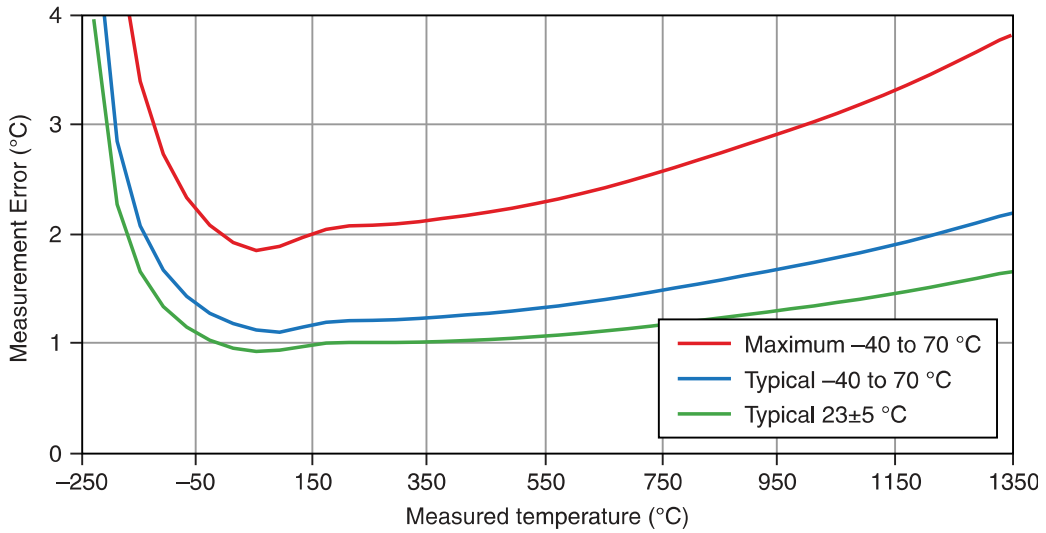

Figure 5. NI 9210 with Mini-TC Thermocouple Type T and E Errors

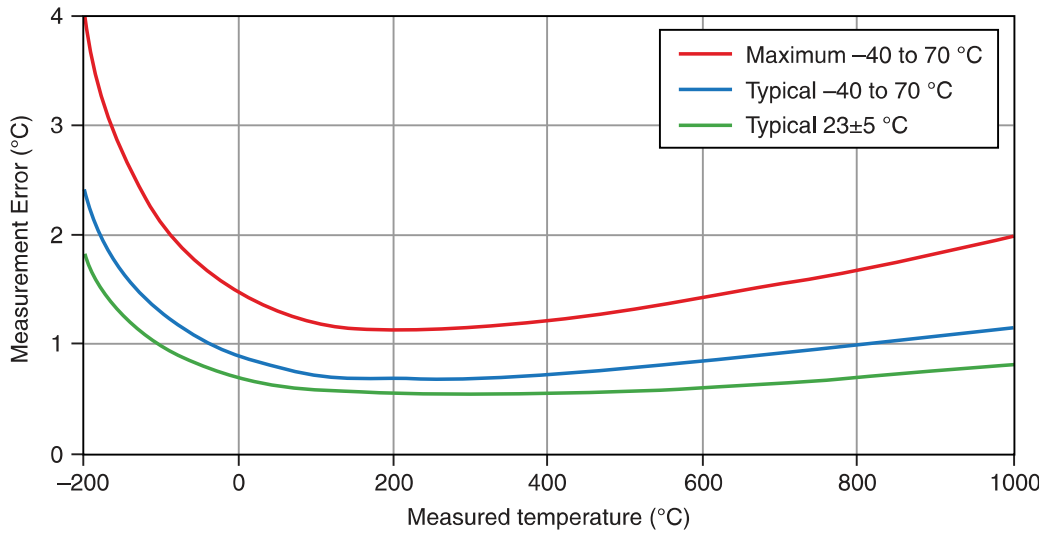

Figure 6. NI 9210 with Spring Terminal Thermocouple Type T and E Errors

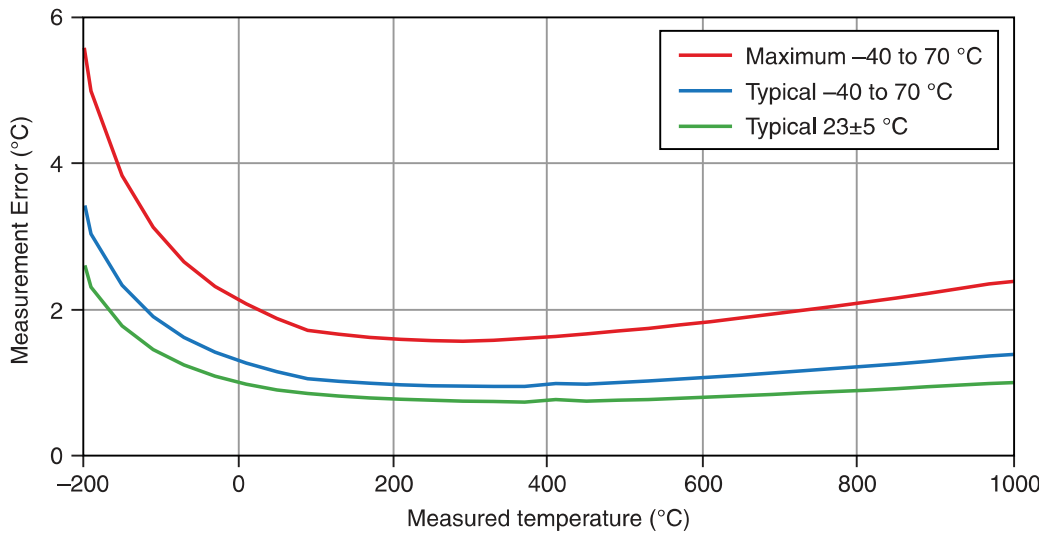

Figure 7. NI 9210 with Mini-TC Thermocouple Type B Errors

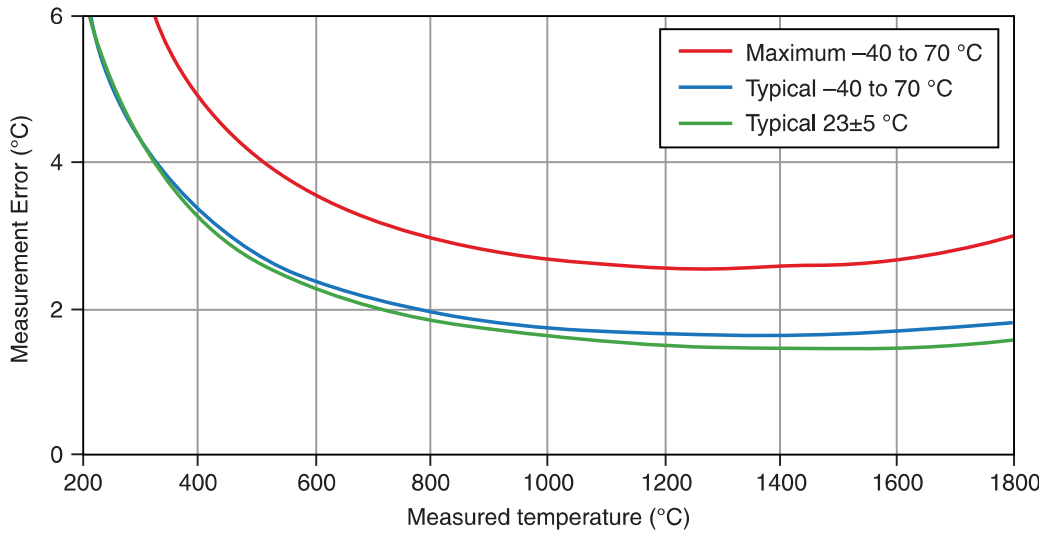

Figure 8. NI 9210 with Spring Terminal Thermocouple Type B Errors

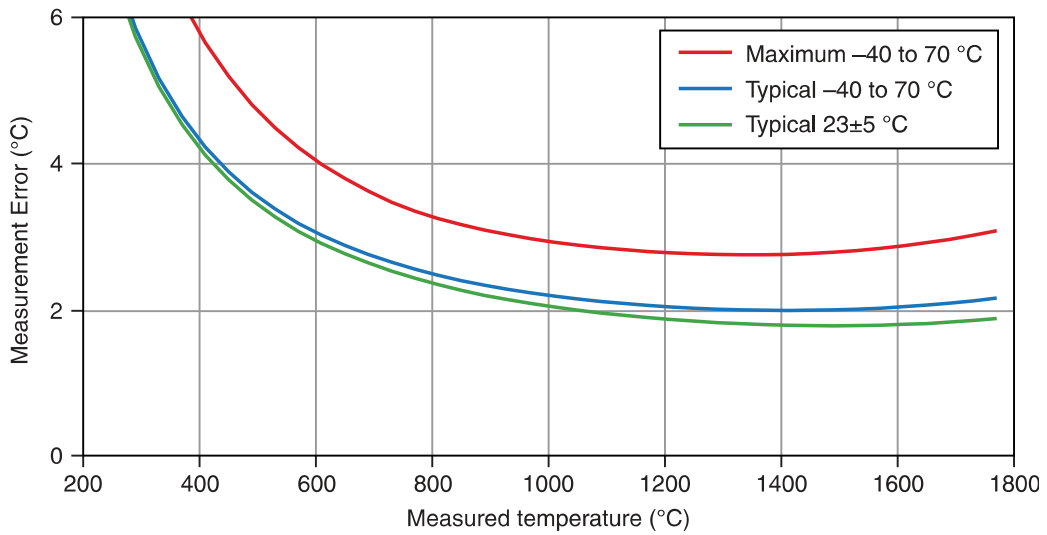

Figure 9. NI 9210 with Mini-TC Thermocouple Type R and S Errors

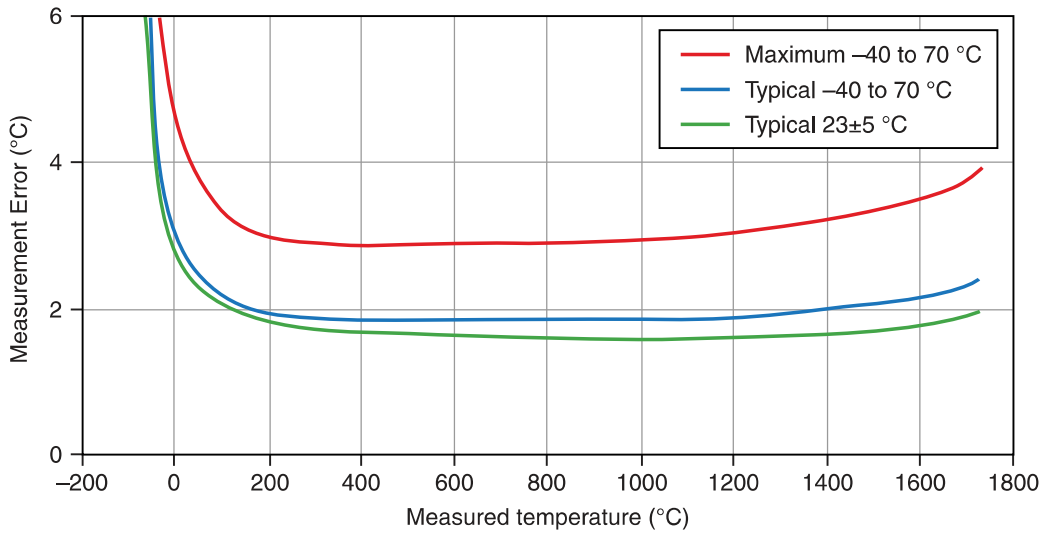
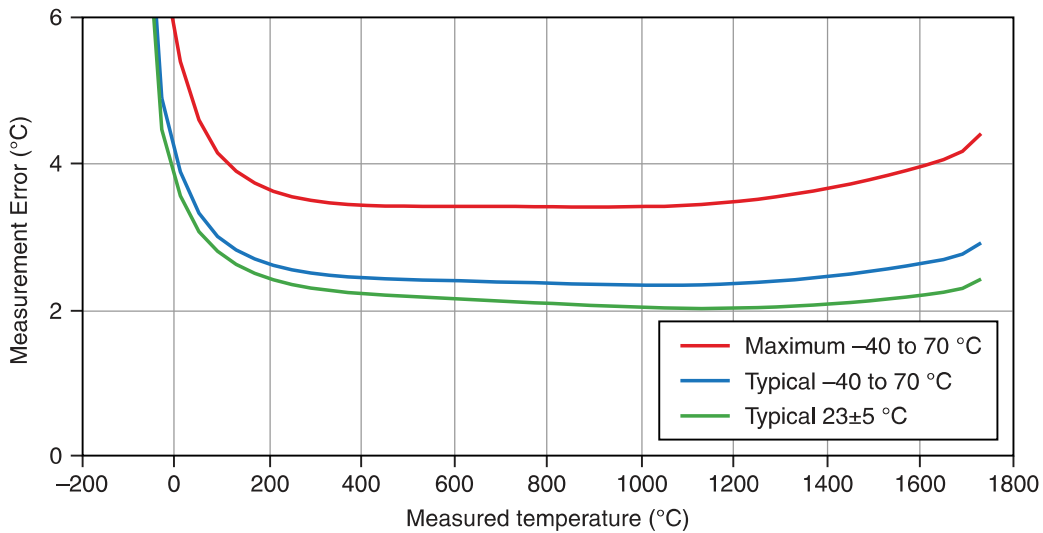

Figure 10. NI 9210 with Spring Terminal Thermocouple Type R and S Errors



Power Requirements

Power consumption from chassis

Active mode	200 mW maximum
Sleep mode	10 mW maximum

Thermal dissipation (at 70 °C)

Active mode	200 mW maximum
Sleep mode	10 mW maximum

NI 9210 with Mini-TC Safety Voltages

Connect only voltages that are within the following limits:

Isolation

Channel-to-channel	None
Channel-to-earth ground	
Continuous	60 V DC, Measurement Category I
Withstand	1,000 V RMS, verified by a 5 s dielectric withstand test

Measurement Category I is for measurements performed on circuits not directly connected to the electrical distribution system referred to as *MAINS* voltage. *MAINS* is a hazardous live electrical supply system that powers equipment. This category is for measurements of voltages from specially protected secondary circuits. Such voltage measurements include signal levels, special equipment, limited-energy parts of equipment, circuits powered by regulated low-voltage sources, and electronics.



Caution Do not connect the NI 9210 with mini-TC to signals or use for measurements within Measurement Categories II, III, or IV.



Note Measurement Categories CAT I and CAT O are equivalent. These test and measurement circuits are for other circuits not intended for direct connection to the *MAINS* building installations of Measurement Categories CAT II, CAT III, or CAT IV.

NI 9210 with Spring Terminal Safety Voltages

Connect only voltages that are within the following limits:

Isolation

Channel-to-channel	None
Channel-to-earth ground	
Continuous	250 V RMS, Measurement Category II
Withstand	3,000 V RMS, verified by a 5 s dielectric withstand test

Measurement Category II is for measurements performed on circuits directly connected to the electrical distribution system. This category refers to local-level electrical distribution, such as that provided by a standard wall outlet, for example, 115 V for U.S. or 230 V for Europe.



Caution Do not connect the NI 9210 with spring terminal to signals or use for measurements within Measurement Categories III or IV.

Physical Characteristics

If you need to clean the module, wipe it with a dry towel.



Tip For two-dimensional drawings and three-dimensional models of the C Series module and connectors, visit ni.com/dimensions and search by module number.

NI 9210 with mini-TC

Input connection

Miniature Thermocouple Jack

Type	Universal
------	-----------

COM connection

Spring terminal wiring

Gauge	0.14 mm ² to 1.5 mm ² (26 AWG to 16 AWG) copper conductor wire
-------	---

Wire strip length	10 mm (0.394 in.) of insulation stripped from the end
-------------------	---

Temperature rating	90 °C, minimum
--------------------	----------------

Wires per spring terminal	Two wires per spring terminal using a 2-wire ferrule
---------------------------	--

Connector securement

Securement type	Screw flanges provided
-----------------	------------------------

Torque for screw flanges	0.2 N · m to 0.25 N · m (1.77 lb · in. to 2.21 lb · in.)
--------------------------	--

Weight	153 g (5.40 oz)
--------	-----------------

NI 9210 with spring terminal

Spring terminal wiring

Gauge	0.2 mm ² to 1.5 mm ² (24 AWG to 16 AWG) thermocouple wire
-------	--

Wire strip length	8 mm of insulation stripped from the end
-------------------	--

Temperature rating	90 °C, minimum
--------------------	----------------

Wires per spring terminal	One wire per spring terminal
---------------------------	------------------------------

Ferrules

Single ferrule, uninsulated	0.2 mm ² to 1 mm ² (26 AWG to 18 AWG)
-----------------------------	---

Single ferrule, insulated	0.2 mm ² to 0.75 mm ² (26 AWG to 18 AWG)
---------------------------	--

Connector securement

Securement type	Screw flanges provided
Torque for screw flanges	0.2 N · m (1.80 lb · in.)
Weight	162 g (5.71 oz)

Hazardous Locations

U.S. (UL)	Class I, Division 2, Groups A, B, C, D, T4; Class I, Zone 2, AEx nA IIC T4 Gc
Canada (C-UL)	Class I, Division 2, Groups A, B, C, D, T4; Ex nA IIC T4 Gc
Europe (ATEX) and International (IECEX)	Ex nA IIC T4 Gc

Safety and Hazardous Locations Standards

This product is designed to meet the requirements of the following electrical equipment safety standards for measurement, control, and laboratory use:

- IEC 61010-1, EN 61010-1
- UL 61010-1, CSA C22.2 No. 61010-1
- EN 60079-0:2012, EN 60079-15:2010
- IEC 60079-0: Ed 6, IEC 60079-15; Ed 4
- UL 60079-0; Ed 6, UL 60079-15; Ed 4
- CSA C22.2 No. 60079-0, CSA C22.2 No. 60079-15



Note For UL and other safety certifications, refer to the product label or the [Online Product Certification](#) section.

Electromagnetic Compatibility

This product meets the requirements of the following EMC standards for electrical equipment for measurement, control, and laboratory use:

- EN 61326-1 (IEC 61326-1): Class A emissions; Industrial immunity
- EN 55011 (CISPR 11): Group 1, Class A emissions
- EN 55022 (CISPR 22): Class A emissions
- EN 55024 (CISPR 24): Immunity
- AS/NZS CISPR 11: Group 1, Class A emissions
- AS/NZS CISPR 22: Class A emissions
- FCC 47 CFR Part 15B: Class A emissions
- ICES-001: Class A emissions



Note In the United States (per FCC 47 CFR), Class A equipment is intended for use in commercial, light-industrial, and heavy-industrial locations. In Europe,

Canada, Australia and New Zealand (per CISPR 11) Class A equipment is intended for use only in heavy-industrial locations.



Note Group 1 equipment (per CISPR 11) is any industrial, scientific, or medical equipment that does not intentionally generate radio frequency energy for the treatment of material or inspection/analysis purposes.



Note For EMC declarations and certifications, and additional information, refer to the [Online Product Certification](#) section.

CE Compliance

This product meets the essential requirements of applicable European Directives, as follows:

- 2014/35/EU; Low-Voltage Directive (safety)
- 2014/30/EU; Electromagnetic Compatibility Directive (EMC)
- 2014/34/EU; Potentially Explosive Atmospheres (ATEX)

Online Product Certification

Refer to the product Declaration of Conformity (DoC) for additional regulatory compliance information. To obtain product certifications and the DoC for this product, visit ni.com/certification, search by model number or product line, and click the appropriate link in the Certification column.

Shock and Vibration

To meet these specifications, you must panel mount the system.

Operating vibration

Random (IEC 60068-2-64)	5 g _{rms} , 10 Hz to 500 Hz
Sinusoidal (IEC 60068-2-6)	5 g, 10 Hz to 500 Hz
Operating shock (IEC 60068-2-27)	30 g, 11 ms half sine; 50 g, 3 ms half sine; 18 shocks at 6 orientations

Environmental

Refer to the manual for the chassis you are using for more information about meeting these specifications.

Operating temperature (IEC 60068-2-1, IEC 60068-2-2)	-40 °C to 70 °C
Storage temperature (IEC 60068-2-1, IEC 60068-2-2)	-40 °C to 85 °C
Ingress protection (with COM plug mated)	IP40
Operating humidity (IEC 60068-2-78)	10% RH to 90% RH, noncondensing

Storage humidity (IEC 60068-2-78)	5% RH to 95% RH, noncondensing
Pollution Degree	2
Maximum altitude	5,000 m

Indoor use only.

Environmental Management

NI is committed to designing and manufacturing products in an environmentally responsible manner. NI recognizes that eliminating certain hazardous substances from our products is beneficial to the environment and to NI customers.

For additional environmental information, refer to the *Minimize Our Environmental Impact* web page at ni.com/environment. This page contains the environmental regulations and directives with which NI complies, as well as other environmental information not included in this document.

Waste Electrical and Electronic Equipment (WEEE)



EU Customers At the end of the product life cycle, all NI products must be disposed of according to local laws and regulations. For more information about how to recycle NI products in your region, visit ni.com/environment/weee.

电子信息产品污染控制管理办法（中国 RoHS）



中国客户 National Instruments 符合中国电子信息产品中限制使用某些有害物质指令 (RoHS)。关于 National Instruments 中国 RoHS 合规性信息，请登录 ni.com/environment/rohs_china。(For information about China RoHS compliance, go to ni.com/environment/rohs_china.)

Calibration

You can obtain the calibration certificate and information about calibration services for the NI 9210 at ni.com/calibration.

Calibration interval	1 year
----------------------	--------

Information is subject to change without notice. Refer to the *NI Trademarks and Logo Guidelines* at ni.com/trademarks for information on NI trademarks. Other product and company names mentioned herein are trademarks or trade names of their respective companies. For patents covering NI products/technology, refer to the appropriate location: **Help»Patents** in your software, the `patents.txt` file on your media, or the *National Instruments Patent Notice* at ni.com/patents. You can find information about end-user license agreements (EULAs) and third-party legal notices in the readme file for your NI product. Refer to the *Export Compliance Information* at ni.com/legal/export-compliance for the NI global trade compliance policy and how to obtain relevant HTS codes, ECCNs, and other import/export data. NI MAKES NO EXPRESS OR IMPLIED WARRANTIES AS TO THE ACCURACY OF THE INFORMATION CONTAINED HEREIN AND SHALL NOT BE LIABLE FOR ANY ERRORS. U.S. Government Customers: The data contained in this manual was developed at private expense and is subject to the applicable limited rights and restricted data rights as set forth in FAR 52.227-14, DFAR 252.227-7014, and DFAR 252.227-7015.

© 2017—2018 National Instruments. All rights reserved.

376338B-02 March 28, 2018