

60 & 40 W, Efficient, Compact Non-Dimmable CV Class 2 / Class II LED Drivers

Nominal Input Voltage	Max. Output Power	Nominal Output Voltage	Max. Output Current	Efficiency	Max. Case Temperature	THD	Power Factor
120 & 277 Vac, 220 to 240 Vac	60 W	12, 24, 48 Vdc	5, 2.5, 1.25 A	up to 90% typical	90°C (measured at the hot spot)	< 20%	> 0.9

Models with Flying Leads, Aluminum Case (VLMXXW Models):

L 130.0 x W 19.65 x H 19.8 mm
(L 5.12 x W 0.77 x H 0.78 in)
VLMXXE dimensions on page 14

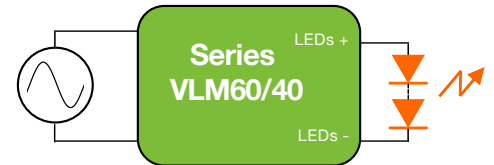

Typical Application Diagram

Models with "-S" Suffix, Bottom Leads with Studs, Aluminum Case:

L 130 x W 19.65 x H 23.85 mm
(L 5.12 x W 0.77 x H 0.94 in)

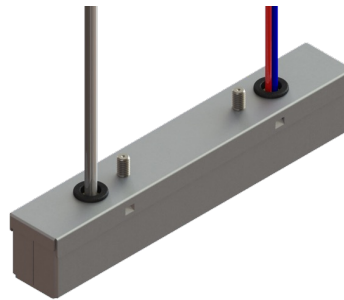

(): Wire Color for VLMXXE models (220-240 Vac)

Wiring Diagram

Models with "-T" Suffix (Terminal Blocks), Aluminum Case:

L 183.2 x W 19.9 x H 19.85 mm
(L 7.12 x W 0.78 x H 0.78 in)

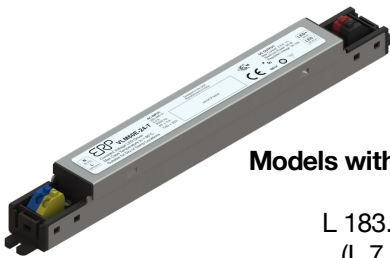

FEATURES

- Very high power density of 20 W/in³
- Class 2 power supply
- Class II power supply per IEC 61347
- IP20-rated case with silicone-based potting
- 90°C maximum case hot spot temperature
- Complies with ENERGY STAR®, DLC (DesignLight Consortium®) and CA Title 24 technical requirements
- Lifetime: 50,000 hours min at 70°C case temperature
- UL Class P
- Worldwide safety approvals SELV Class 2
- Additional safety approvals when using the optional strain reliefs for models with "-T" suffix

TYPICAL APPLICATIONS

- Strip lights
- Pendants
- Linears
- Cove Lights



Note: The VLM series is a dedicated constant voltage LED driver. Some alternative loads may have large input capacitance or other drive current demands not compatible for use with the VLM series. The performance of the VLM series must be tested and qualified thoroughly when being used to drive alternative electronic circuit loads other than LED loads. The VLM series drivers are designed and characterized to be compatible with Lumenetix brand light engines.

60 & 40 W, Efficient, Compact Non-Dimmable CV Class 2 / Class II LED Drivers

1 - ORDERING INFORMATION

ERP Part Number	Nominal Input Voltage (Vac)	Pout Max (W)	Vout Nom (Vdc)	Iout Min (A)	Iout Max (A)	Open Loop Voltage (No Load Vout Max) (Vdc)	Comments	Safety, EMC Compliance
VLM40W								
VLM40W-12	120 & 277	40	12	0.1	3.3	12.84	Aluminum case with flying leads	UL, cUL, FCC
VLM40W-24	120 & 277	40	24	0.05	1.67	25.68	Aluminum case with flying leads	UL, cUL, FCC
VLM40W-48	120 & 277	40	48	0.025	0.83	51.36	Aluminum case with flying leads	UL, cUL, FCC
VLM40W-12-S	120 & 277	40	12	0.1	3.3	12.84	Aluminum case with bottom leads and studs	UL, cUL, FCC
VLM40W-24-S	120 & 277	40	24	0.05	1.67	25.68	Aluminum case with bottom leads and studs	UL, cUL, FCC
VLM40W-48-S	120 & 277	40	48	0.025	0.83	51.36	Aluminum case with bottom leads and studs	UL, cUL, FCC
VLM60W								
VLM60W-12	120 & 277	60	12	0.1	5	12.84	Aluminum case with flying leads	UL, cUL, FCC
VLM60W-24	120 & 277	60	24	0.05	2.5	25.68	Aluminum case with flying leads	UL, cUL, FCC
VLM60W-36	120 & 277	60	36	0.033	1.67	38.52	Aluminum case with flying leads	UL, cUL, FCC
VLM60W-48	120 & 277	60	48	0.025	1.25	51.36	Aluminum case with flying leads	UL, cUL, FCC
VLM60W-12-S	120 & 277	60	12	0.1	5	12.84	Aluminum case with bottom leads and studs	UL, cUL, FCC
VLM60W-24-S	120 & 277	60	24	0.05	2.5	25.68	Aluminum case with bottom leads and studs	UL, cUL, FCC
VLM60W-48-S	120 & 277	60	48	0.025	1.25	51.36	Aluminum case with bottom leads and studs	UL, cUL, FCC
VLM40E								
VLM40E-12-T	220 to 240	40	12	0.1	3.3	12.84	Aluminum case with terminal blocks	CB, ENEC,CE
VLM40E-24-T	220 to 240	40	24	0.05	1.67	25.68	Aluminum case with terminal blocks	CB, ENEC,CE
VLM40E-48-T	220 to 240	40	48	0.025	0.83	51.36	Aluminum case with terminal blocks	CB, ENEC,CE
VLM60E								
VLM60E-24	220 to 240	60	24	0.05	2.5	25.68	Aluminum case with flying leads	CB, ENEC,CE
VLM60E-48	220 to 240	60	48	0.025	1.25	51.36	Aluminum case with flying leads	CB, ENEC,CE
VLM60E-12-T	220 to 240	60	12	0.1	5	12.84	Aluminum case with terminal blocks	CB, ENEC,CE
VLM60E-24-T	220 to 240	60	24	0.05	2.5	25.68	Aluminum case with terminal blocks	CB, ENEC,CE
VLM60E-48-T	220 to 240	60	48	0.025	1.25	51.36	Aluminum case with terminal blocks	CB, ENEC,CE

Notes:

1. Strain reliefs for "-T" models are not included and can be ordered separately using part number SR1. Order quantity for SR1 is per strain relief, and 2 strain reliefs are needed for each driver.

60 & 40 W, Efficient, Compact Non-Dimmable CV Class 2 / Class II LED Drivers

2 - INPUT SPECIFICATION (@25° C ambient temperature)

	Units	Minimum	Typical	Maximum	Notes
Input Voltage Range (Vin) - VLMXXW models	Vac	90	120 & 277	305	<ul style="list-style-type: none"> The rated output voltage for each model is achieved at $V_{in} \geq 105$ Vac & at $V_{in} \geq 249$ Vac for VLMXXW models, and at $V_{in} \geq 209$ Vac for VLMXXE models. At maximum load, as specified in section 1.
		198	230	264	
Input Frequency Range - VLMXXW models	Hz	47	60	63	
		47	50/60	63	
Input Current (Iin)	A			0.7 A @ 120 Vac 0.4 A @ 230 vac 0.3 A @ 277 Vac	
Max Units on a 16 A Circuit Breaker		VLM40: 38 (120 Vac), 71 (230 Vac), 88 (277 Vac) units VLM60: 25 (120 Vac), 48 (230 Vac), 59 (277 Vac) units			The maximum number of units allowed per 16 A circuit breaker is based on worst-case conditions at 100% output.
Power Factor (PF)		0.9	> 0.9		<ul style="list-style-type: none"> At nominal input voltage From 100% to 60% of rated power
Inrush Current	A	Meets NEMA-410 requirements			At any point on the sine wave and 25°C
Leakage Current	µA			400 µA @ 120 Vac 700 µA @ 230 Vac 920 µA @ 277 Vac	Measured per IEC60950-1
Input Harmonics	Complies with IEC61000-3-2 for Class C equipment				
Total Harmonics Distortion (THD)				20%	<ul style="list-style-type: none"> At nominal input voltage From 100% to 60% of rated power Complies with DLC (Design Light Consortium) technical requirements
Efficiency	%	-	up to 90%	-	Measured with nominal input voltage
Isolation	The AC input to the main DC output is isolated.				

3 - MAIN OUTPUT SPECIFICATION (@25° C ambient temperature)

	Units	Minimum	Typical	Maximum	Notes
Output Voltage (Vout)	Vdc		12, 24, 48		See ordering information for details
Output Current (Iout)	A			12 Vdc: 5.0 A 24 Vdc: 2.5 A 48 Vdc: 1.25 A	The rated output voltage for each model is achieved at $V_{in} \geq 105$ Vac & at $V_{in} \geq 249$ Vac for VLMXXW models, and at $V_{in} \geq 209$ Vac for VLMXXE models.
Output Voltage Regulation	%	-5		5	<ul style="list-style-type: none"> At nominal AC line voltage Includes load and current set point variations.
Output Voltage Overshoot	%	-	-	10	The driver does not operate outside of the regulation requirements for more than 500 ms during power on with maximum load.
Ripple Voltage	≤ 5% of rated output voltage for each model				<ul style="list-style-type: none"> Measured at maximum load and nominal input voltage Calculated in accordance with the IES Lighting Handbook, 9th edition
Start-up Time	ms			500	<ul style="list-style-type: none"> Measured from application of AC line voltage to 100% light output Complies with California Title 24 and ENERGY STAR® luminaire specification.

60 & 40 W, Efficient, Compact Non-Dimmable CV Class 2 / Class II LED Drivers

4 - ENVIRONMENTAL CONDITIONS

	Units	Minimum	Typical	Maximum	Notes
Operating Ambient Temperature (Ta)	°C	-20		50	50°C is the non-derated temperature (Refer to section 7 "Output power de-rating at higher temperatures").
Maximum Case Temperature (Tc)	°C			+90	Case temperature measured at the hot spot •tc (see label in page 13)
Storage Temperature	°C	-40		+85	
Humidity	%	5	-	95	Non-condensing
Cooling	Convection cooled				
Acoustic Noise	dBa			22	Measured at a distance of 1 foot (30 cm)
Mechanical Shock Protection	per EN60068-2-27				
Vibration Protection	per EN60068-2-6 & EN60068-2-64				
MTBF	> 200,000 hours when operated at nominal input and output conditions, and at Tc ≤ 70°C				
Lifetime	50,000 hours at Tc ≤ 70°C maximum case hot spot temperature (see hot spot •tc on label in page 13)				

5 - EMC COMPLIANCE AND SAFETY APPROVALS

EMC Compliance

Conducted and Radiated EMI	<ul style="list-style-type: none"> •VLMXXW models: Compliant with FCC CFR Title 47 Part 15 Class B at 120 Vac & Class A at 277 Vac •VLMXXE models: EN55015 (CISPR 15) compliant at 220, 230, and 240 Vac 				
Harmonic Current Emissions	IEC61000-3-2		For Class C equipment		
Voltage Fluctuations & Flicker	IEC61000-3-3				
Immunity Compliance	ESD (Electrostatic Discharge)	IEC61000-4-2	6 kV contact discharge, 8 kV air discharge, level 3		
	RF Electromagnetic Field Susceptibility	IEC61000-4-3	3 V/m, 80 - 1000 MHz, 80% modulated at a distance of 3 meters		
	Electrical Fast Transient	IEC61000-4-4	± 2 kV on AC power port for 1 minute, ±1 kV on signal/control lines		
	Surge	IEC61000-4-5	± 2 kV line to line (differential mode) / ± 2 kV line to common mode ground		
		ANSI/IEEE c62.41.1-2002 & c62.41.2-2002 category A, 2.5 kV ring wave			
	Conducted RF Disturbances	IEC61000-4-6	3V, 0.15-80 MHz, 80% modulated		
Voltage Dips	IEC61000-4-11	>95% dip, 0.5 period; 30% dip, 25 periods; 95% reduction, 250 periods			

Safety Agency Approvals

UL	VLMXXW models: UL8750 listed Class 2
cUL	VLMXXW models: CAN/CSA C22.2 No. 250.13-14 LED equipment for lighting applications
CE	VLMXXE models: IEC61347-2-13 electronic control gear for LED Modules & EN55015 (EMC compliance)
CB	VLMXXE models
ENEC	VLMXXE models

Safety

	Units	Minimum	Typical	Maximum	Notes
Hi Pot (High Potential) or Dielectric voltage-withstand - VLMXXW models	Vdc	2500			<ul style="list-style-type: none"> •Insulation between the input (AC line and Neutral) and the output •Tested at the RMS voltage equivalent of 1768 Vac
- VLMXXE models		4242			<ul style="list-style-type: none"> •Tested at the RMS voltage equivalent of 3000 Vac •Meets class II reinforced/double insulation 

60 & 40 W, Efficient, Compact Non-Dimmable CV Class 2 / Class II LED Drivers

6 - PROTECTION FEATURES

Under-Voltage (Brownout)

The VLM60/40 series provides protection circuitry such that an application of an input voltage below the minimum stated in section 1 (Input Specification) shall not cause damage to the driver.

Short Circuit and Over Current Protection

The VLM60/40 series is protected against short-circuit such that a short from any output to return shall not result in a fire hazard or shock hazard. The driver shall hiccup as a result of a short circuit or over current fault. Removal of the fault will return the driver to within normal operation. The driver shall recover, with no damage, from a short across the output for an indefinite period of time.

Internal Over temperature Protection

The VLM60/40 is equipped with an internal temperature sensor on the primary power train. Failure to stay within the convection power rating will cause the driver to shut down. The main output current will be resumed when the temperature of the built-in temperature sensor cools adequately.

Output Open Load

The VLM60/40 is not intended to be operated in a no load condition; however, a no load condition will not damage the VLM60/40 or cause a hazardous condition. The driver will remain stable and operate normally after application of a load. When the LED load is removed, the output voltage of the VLM60/40 series is limited to 7% about the output voltage of each model.

Over Power Protection

The VLM60/40 will shut down and auto recover when its input power exceeds approximately 110% of 96 W. This condition will cause no damage to the power supply.

Input Over Current Protection

The VLM60/40 series incorporates a primary AC line fuse for input over current protection.

7 - OUTPUT POWER DE-RATING AT ELEVATED TEMPERATURES

The VLM60/40 series can be operated with cooling air temperatures above 50°C by linearly de-rating the total maximum output power (or current) by 2.5%/°C from 50°C to 70°C (see figure 1).

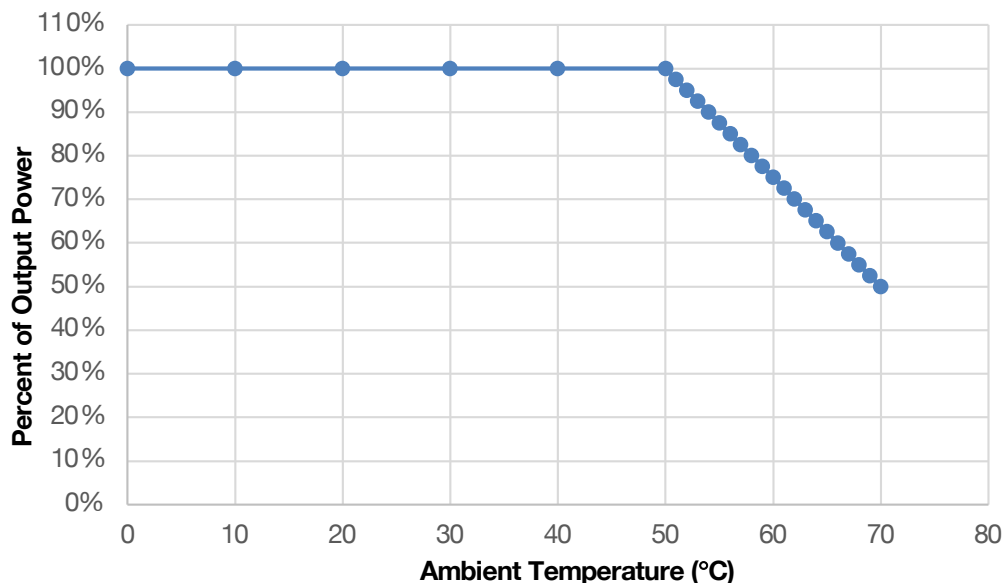

Figure 1

60 & 40 W, Efficient, Compact Non-Dimmable CV Class 2 / Class II LED Drivers

8 - PREDICTED LIFETIME VERSUS CASE AND AMBIENT TEMPERATURE

Lifetime is defined by the measurement of the temperatures of all the electrolytic capacitors whose failure would affect light output under the nominal LED load and worst case AC line voltage. The graphs in figures 2 and 3 are determined by the electrolytic capacitor with the shortest lifetime, among all electrolytic capacitors. It represents a worst case scenario in which the LED driver is powered 24 hours/day, 7 days/week. The lifetime of an electrolytic capacitor is measured when any of the following changes in performance are observed:

- 1) Capacitance changes more than 20% of initial value
- 2) Dissipation Factor ($\tan \delta$): 150% or less of initial specified value
- 3) Equivalent Series Resistance (ESR): 150% or less of initial specified value
- 4) Leakage current: less of initial specified value

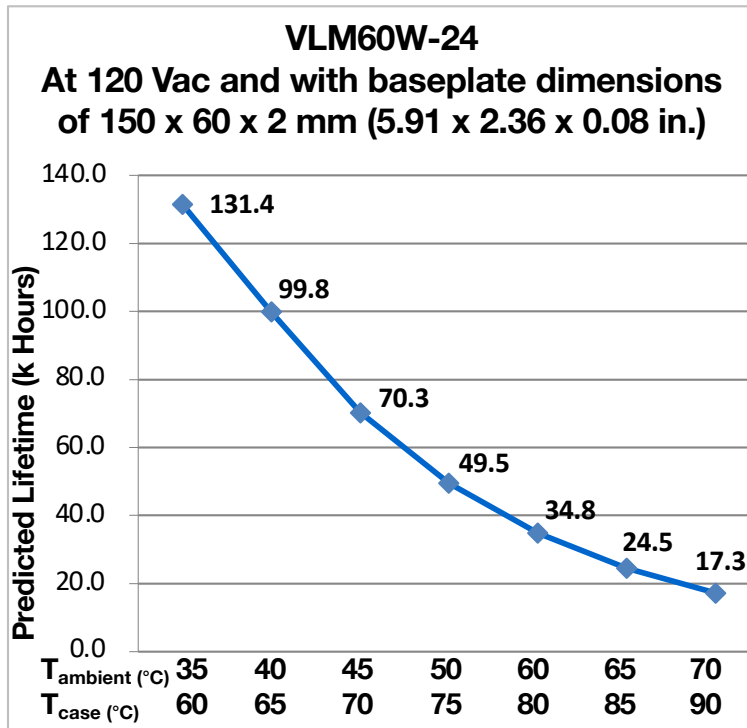

Figure 2

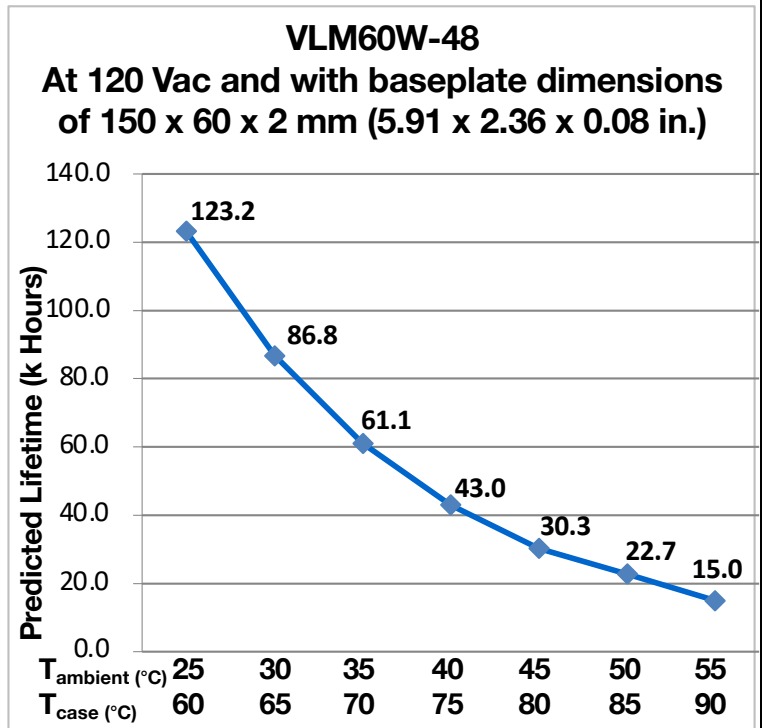

Figure 3

Notes:

- The ambient temperature T_{ambient} and the differential between T_{ambient} and T_{case} mentioned in the above graphs are relevant only as long as both the driver and the light fixture are exposed to the same ambient room temperature. If the LED driver is housed in an enclosure or covered by insulation material, then the ambient room temperature is no longer valid. In this situation, please refer only to the case temperature T_{case} .
- It should be noted the graph "Lifetime vs. Ambient Temperature" may have an error induced in the final application if the mounting has restricted convection flow around the case. For applications where this is evident, the actual case temperature measured at the T_c point in the application should be used for reliability calculations.

60 & 40 W, Efficient, Compact Non-Dimmable CV Class 2 / Class II LED Drivers

9 – EFFICIENCY VERSUS LOAD

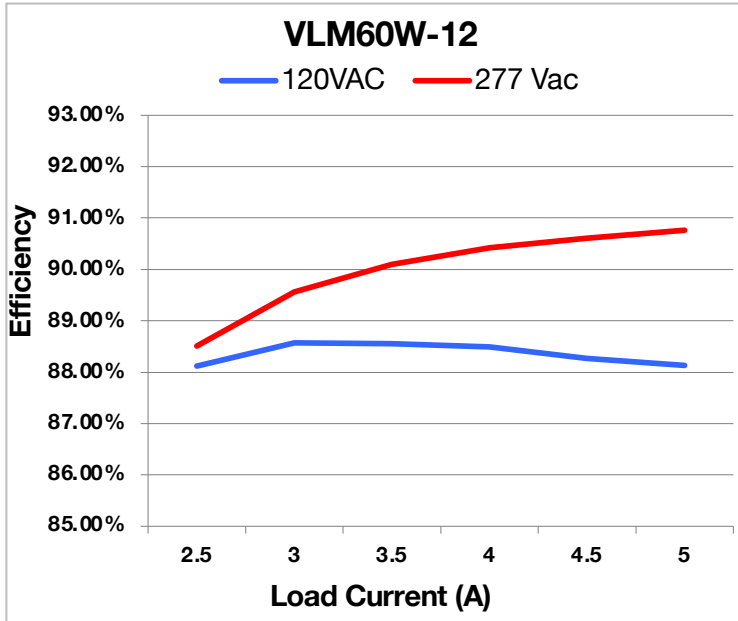

Figure 4

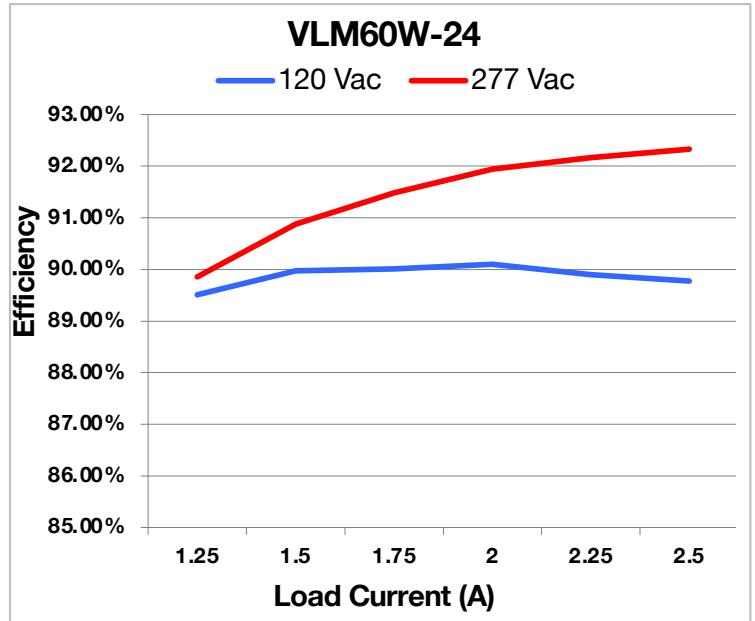

Figure 5

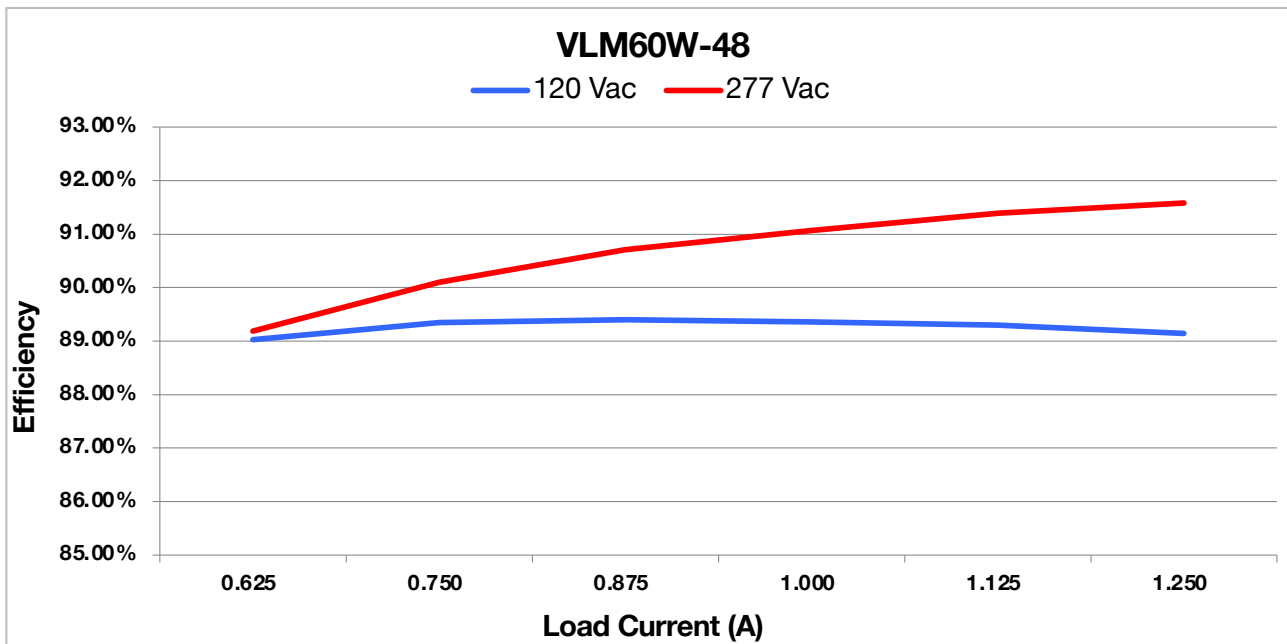

Figure 6

60 & 40 W, Efficient, Compact Non-Dimmable CV Class 2 / Class II LED Drivers

9 – EFFICIENCY VERSUS LOAD (CONTINUED)

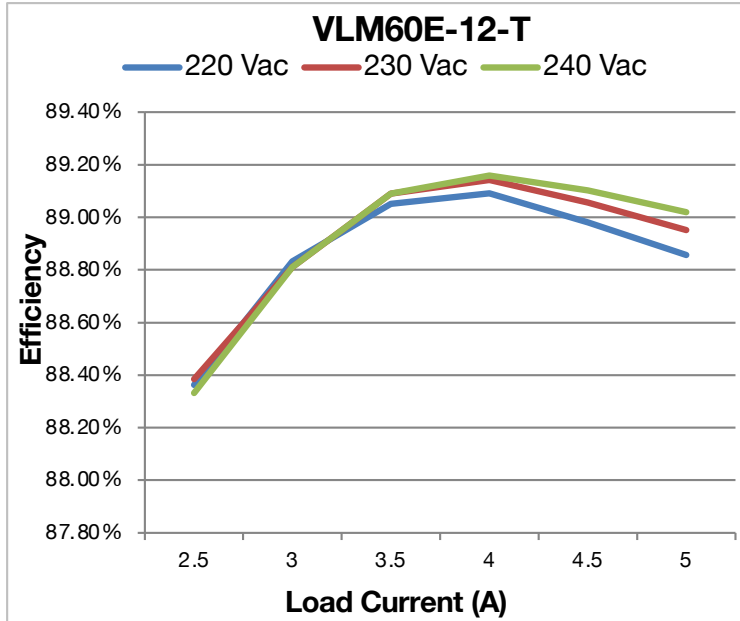

Figure 7

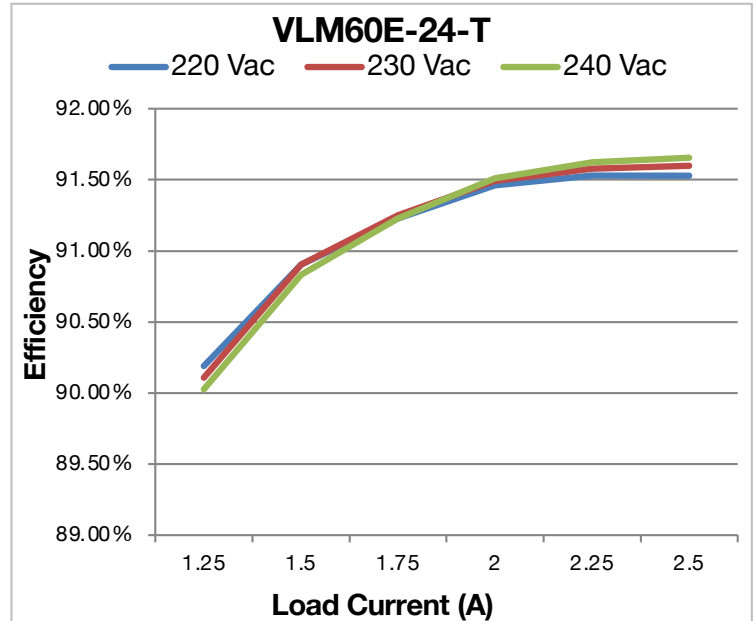

Figure 8

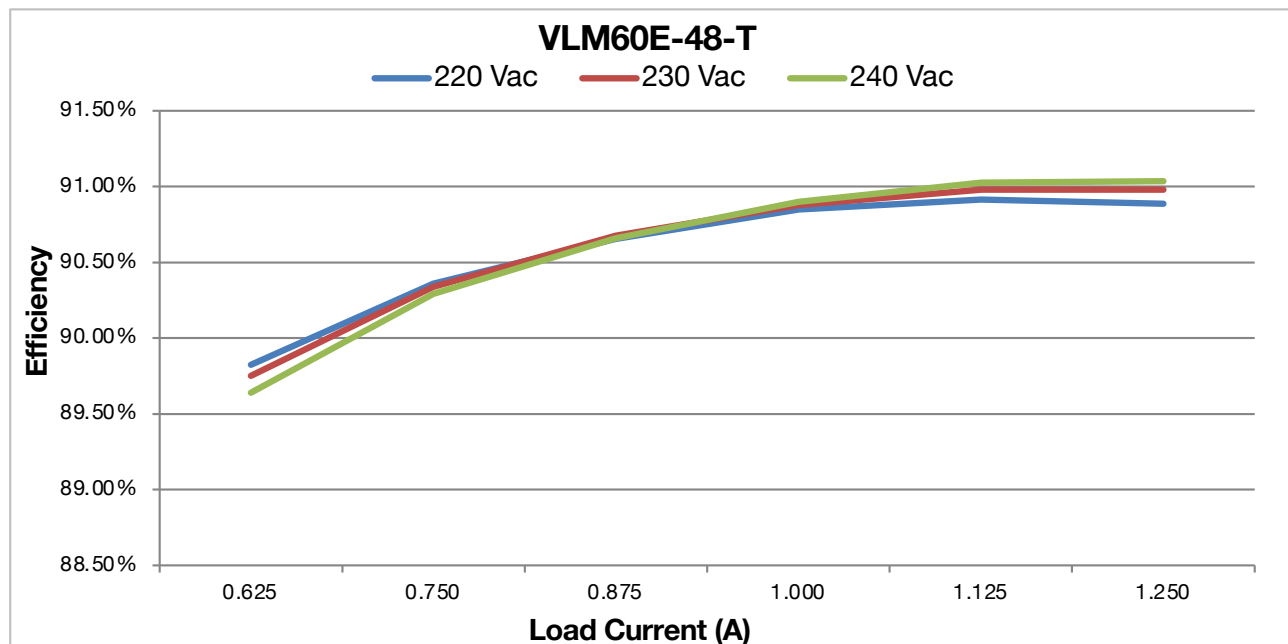

Figure 9

60 & 40 W, Efficient, Compact Non-Dimmable CV Class 2 / Class II LED Drivers

10 – POWER FACTOR VERSUS LOAD

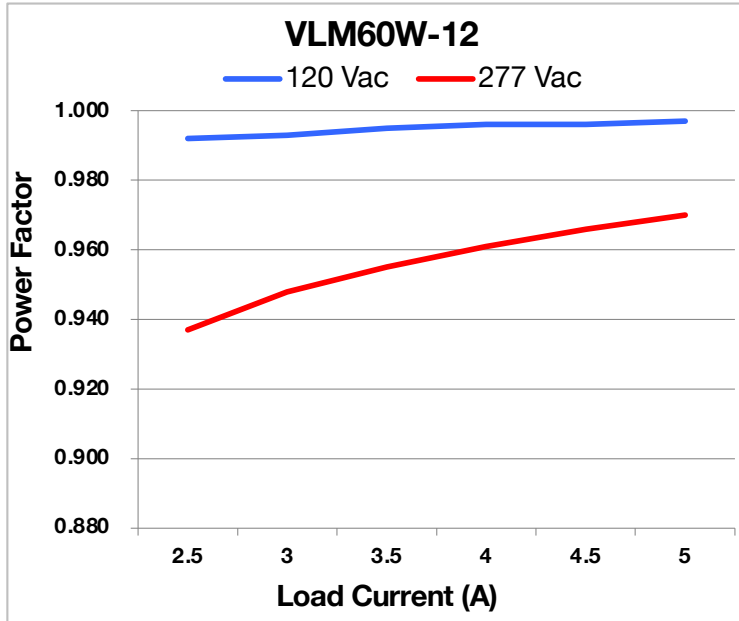

Figure 10

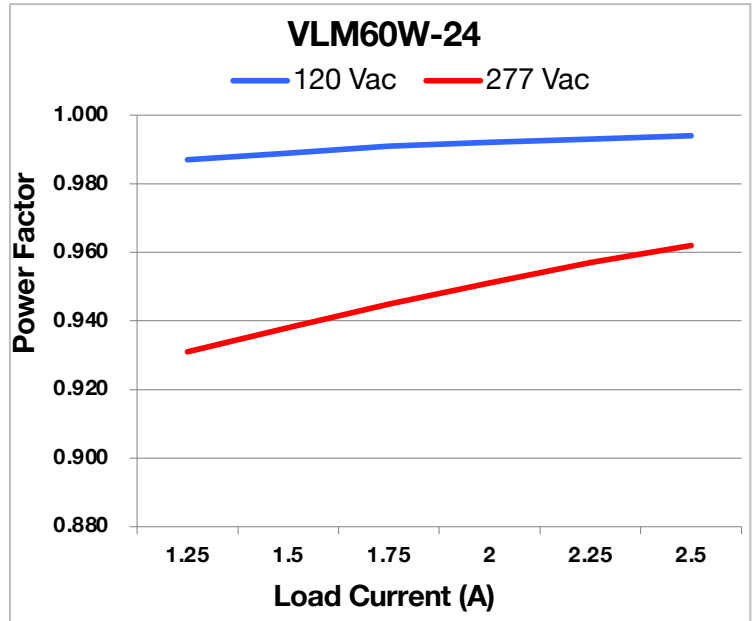

Figure 11

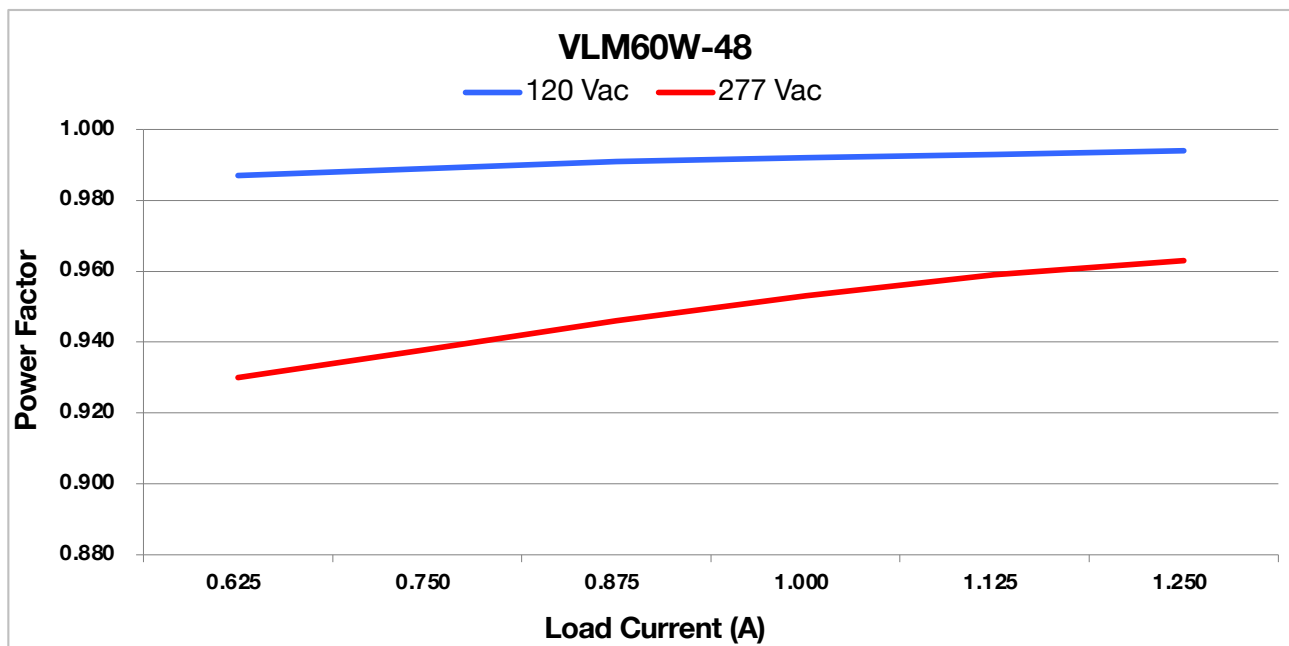

Figure 12

60 & 40 W, Efficient, Compact Non-Dimmable CV Class 2 / Class II LED Drivers

10 – POWER FACTOR VERSUS LOAD (CONTINUED)

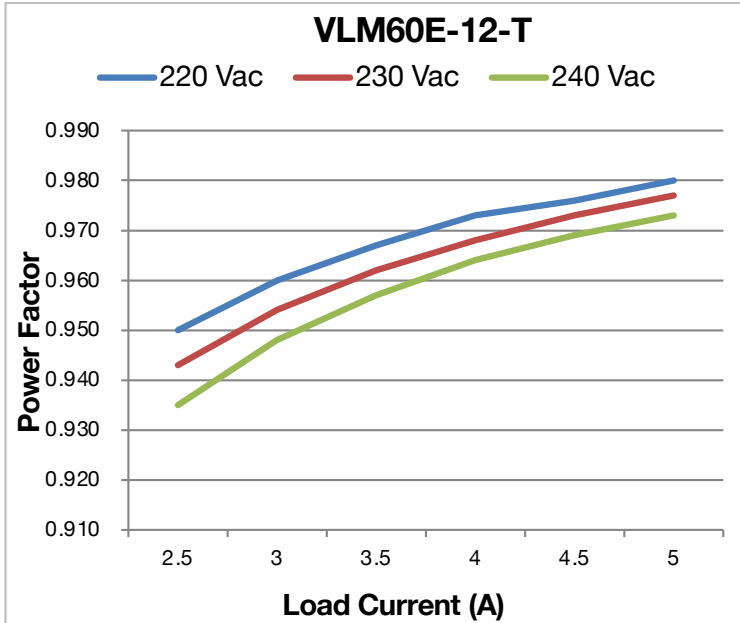

Figure 13

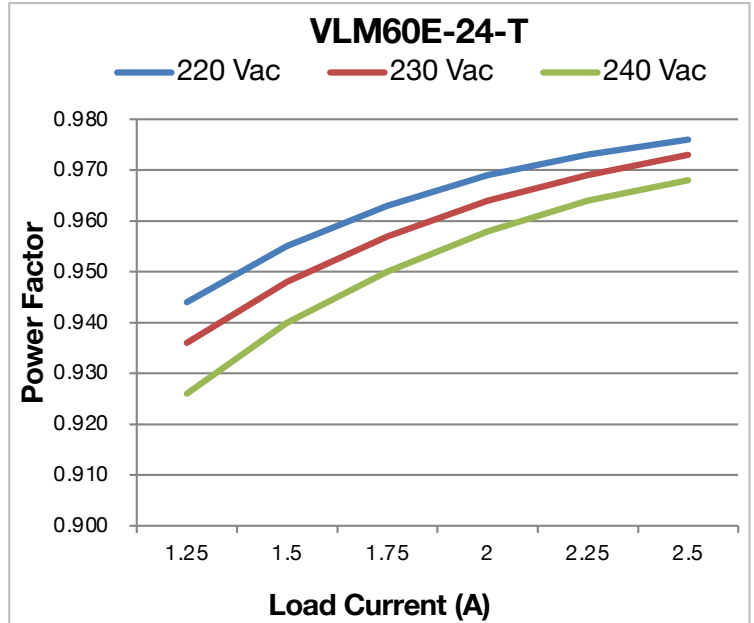

Figure 14

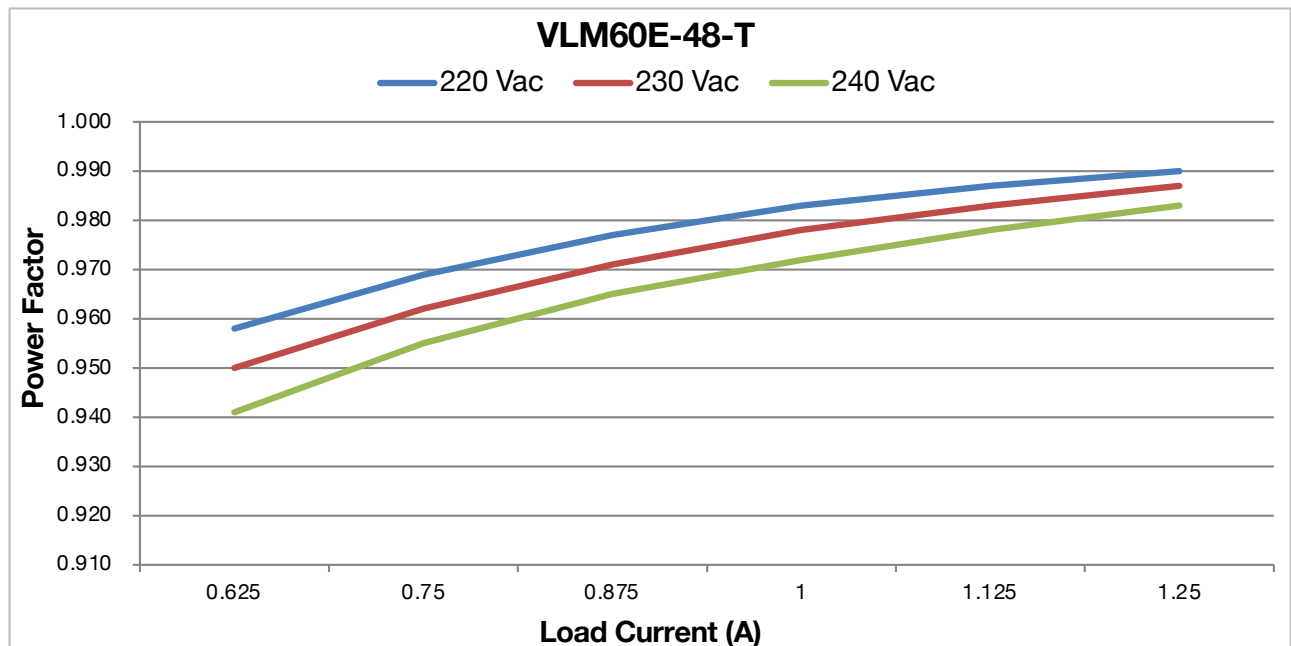

Figure 15

60 & 40 W, Efficient, Compact Non-Dimmable CV Class 2 / Class II LED Drivers

11 – THD VERSUS LOAD

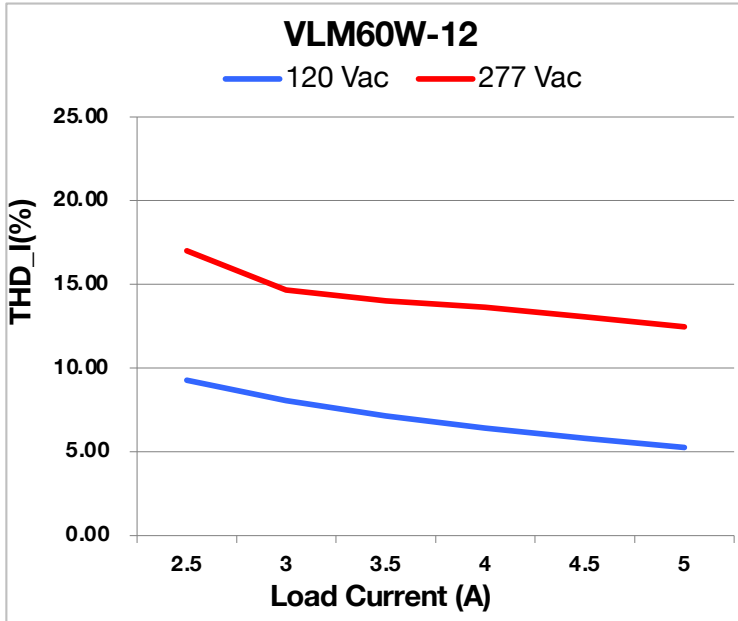

Figure 16

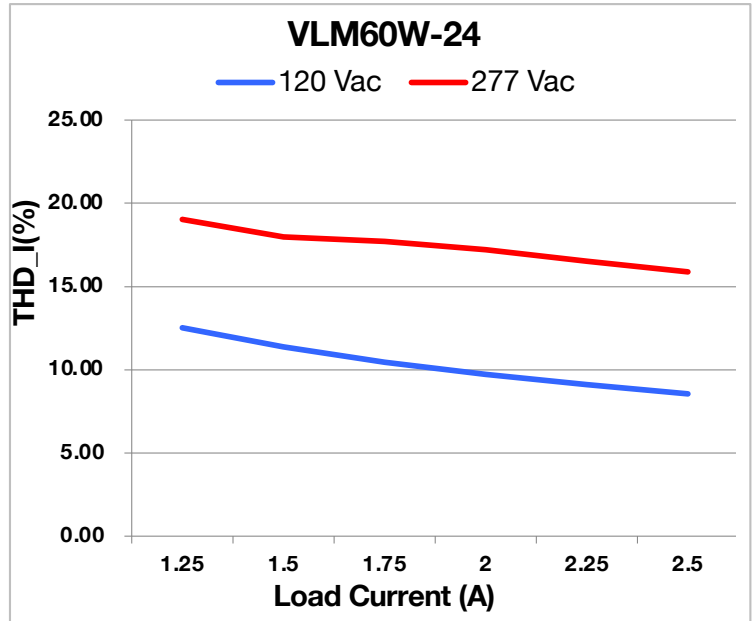

Figure 17

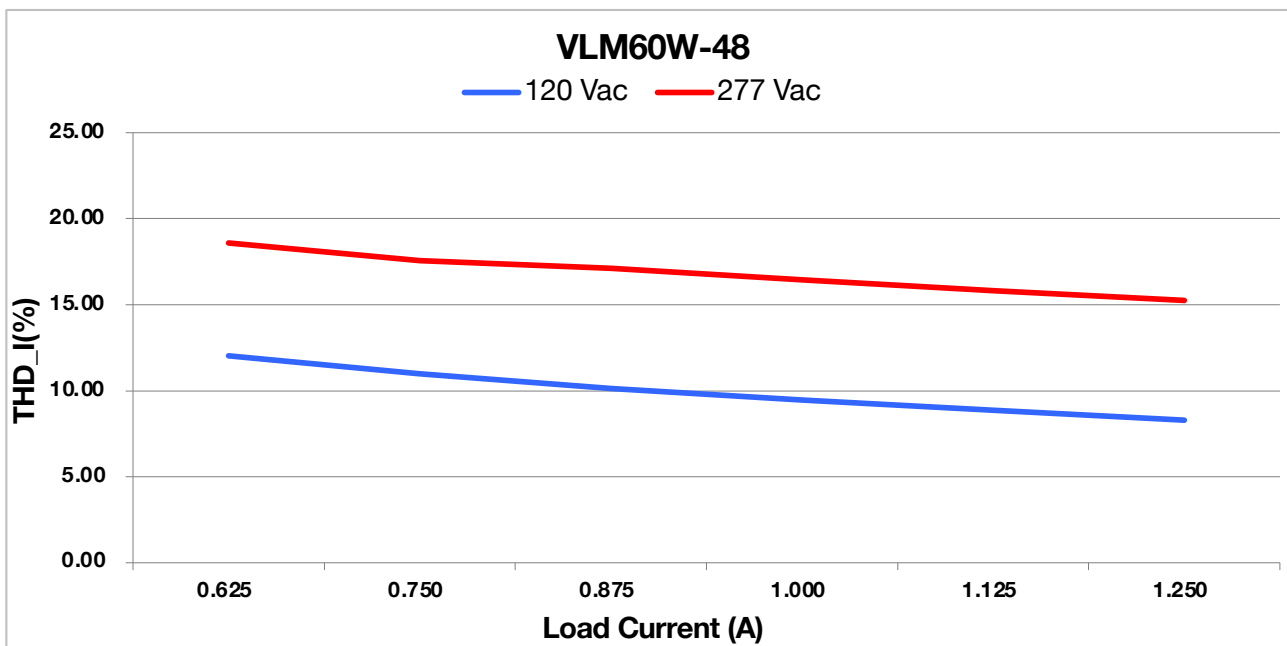

Figure 18

60 & 40 W, Efficient, Compact Non-Dimmable CV Class 2 / Class II LED Drivers

11 – THD VERSUS LOAD (CONTINUED)

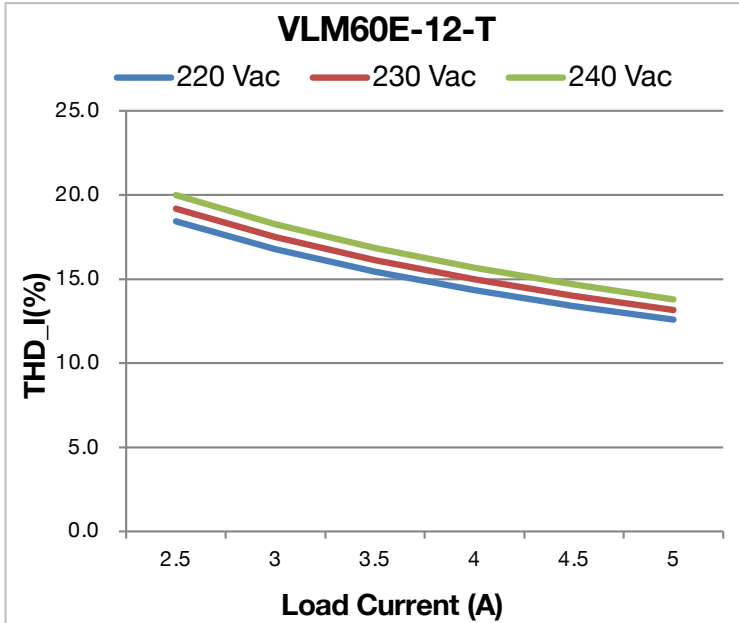

Figure 19

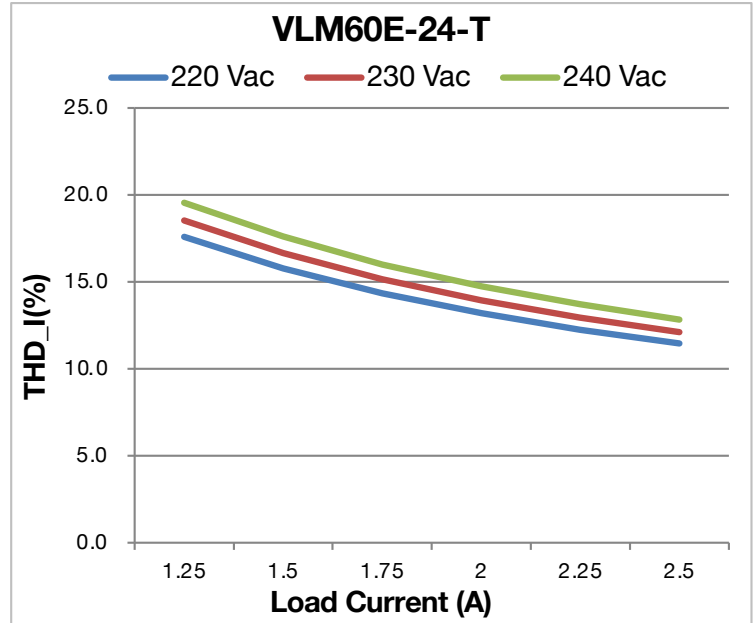

Figure 20

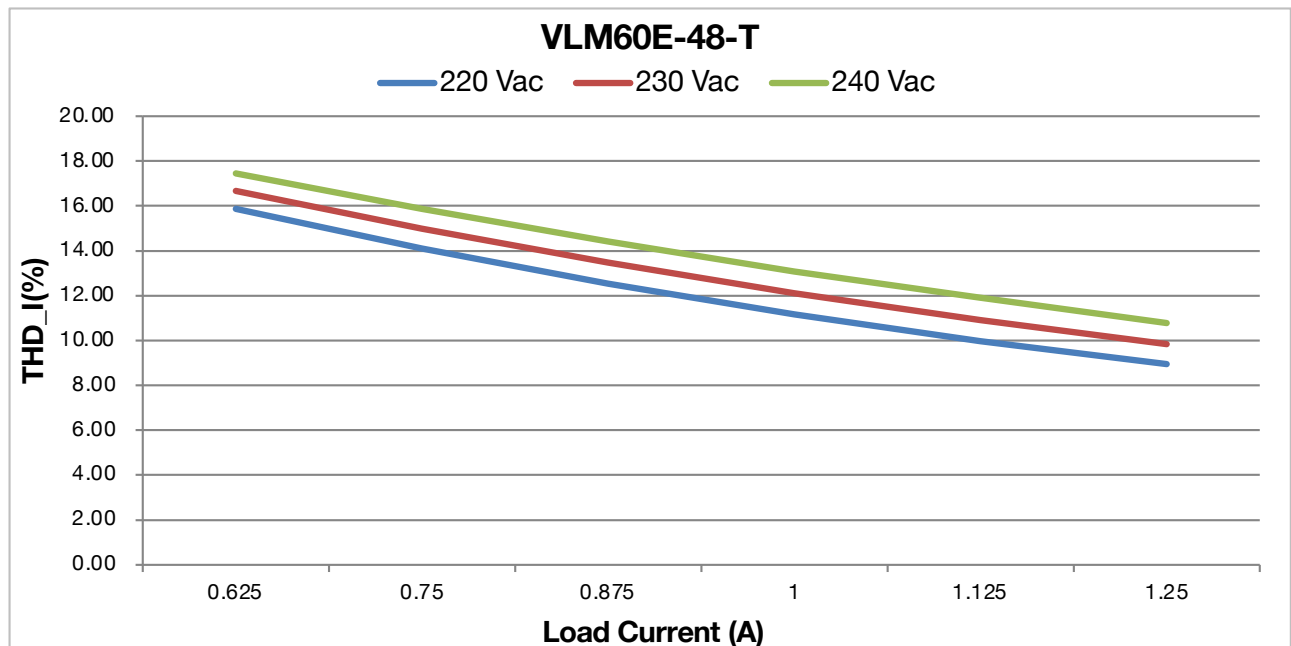

Figure 21

60 & 40 W, Efficient, Compact Non-Dimmable CV Class 2 / Class II LED Drivers

12 - MECHANICAL DETAILS

- **Packaging Options:** Aluminum case
- **I/O Connections:**
 - **Models with flying leads:** 18 AWG on all leads, 203mm (8 in) long, 105°C rated, stranded, stripped by approximately 9.5 mm, and tinned. All the wires, on both input and output, have a 300 V insulation rating.
 - **Models with "S" suffix:** Terminal blocks
 - **Models with "T" suffix:** Terminal blocks
- **Ingress Protection:** IP20 rated
- **Mounting Instructions:** The VLM60/40 driver case must be secured on a flat surface through the two mounting tabs, shown here below in the case outline drawings. We recommended mounting the VLM60/40 on a baseplate with dimensions of 150 x 60 x 2 mm (5.91 x 2.36 x 0.08 in).

13 - OUTLINE DRAWINGS (VLMXXW MODELS WITH FLYING LEADS)

Dimensions: L 130.0 x W 19.65 x H 19.8 mm (L 5.12 x W 0.77 x H 0.78 in)

Weight: 119 g (4.20 oz)

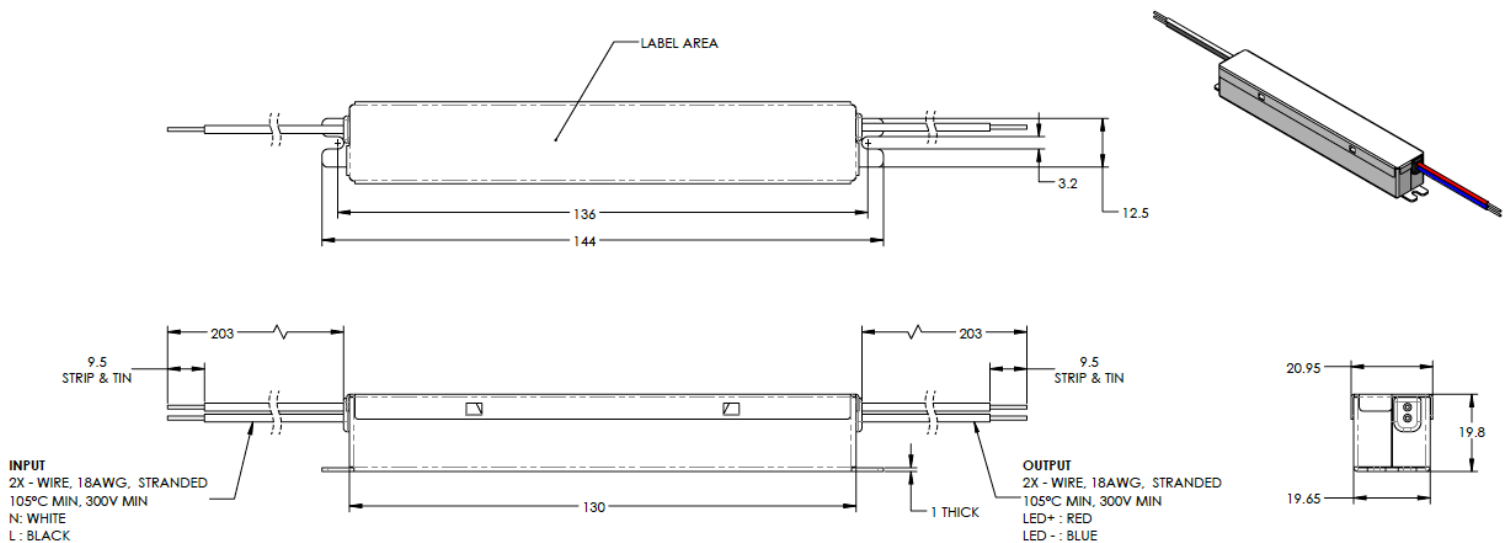

All dimensions are in mm

Figure 22

60 & 40 W, Efficient, Compact Non-Dimmable CV Class 2 / Class II LED Drivers

14 - OUTLINE DRAWINGS (VLMXXE MODELS WITH FLYING LEADS)

Dimensions: L 141 x W 19.7 x H 19.8 mm (L 5.55 x W 0.78 x H 0.78 in)

Weight: 122 g (4.30 oz)

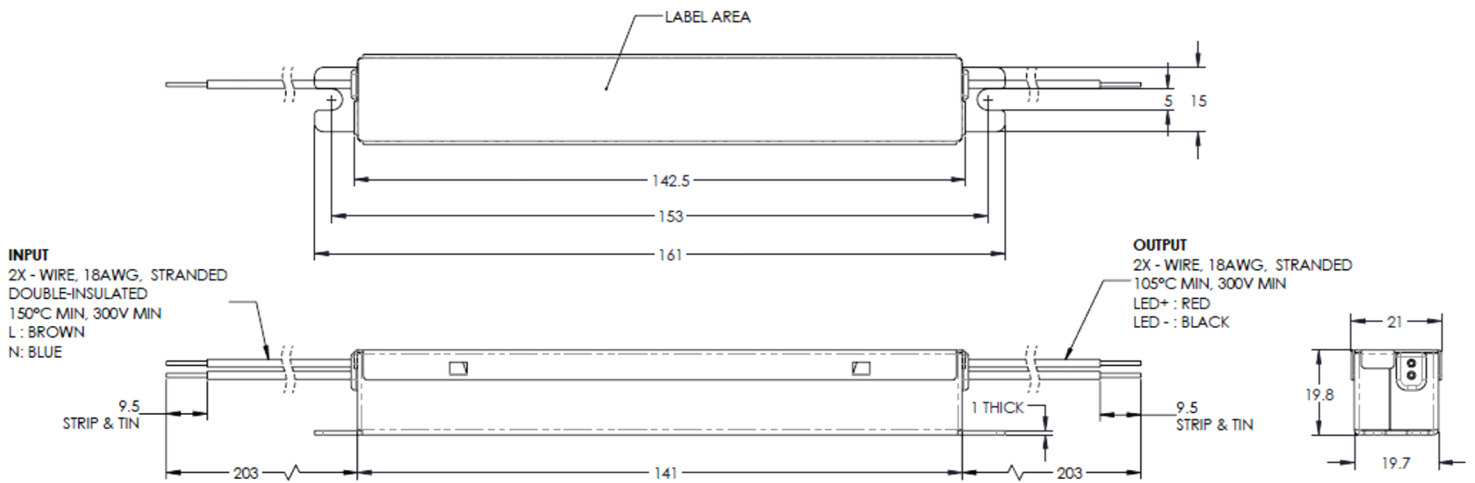

All dimensions are in mm

Figure 23

60 & 40 W, Efficient, Compact Non-Dimmable CV Class 2 / Class II LED Drivers

15 - OUTLINE DRAWINGS (MODELS WITH "-T" SUFFIX: TERMINAL BLOCKS)

Dimensions: L 183.2 x W 19.9 x H 19.85 mm (L 8.03 x W 0.78 x H 0.78 in)

Weight: 127 g (4.48 oz)

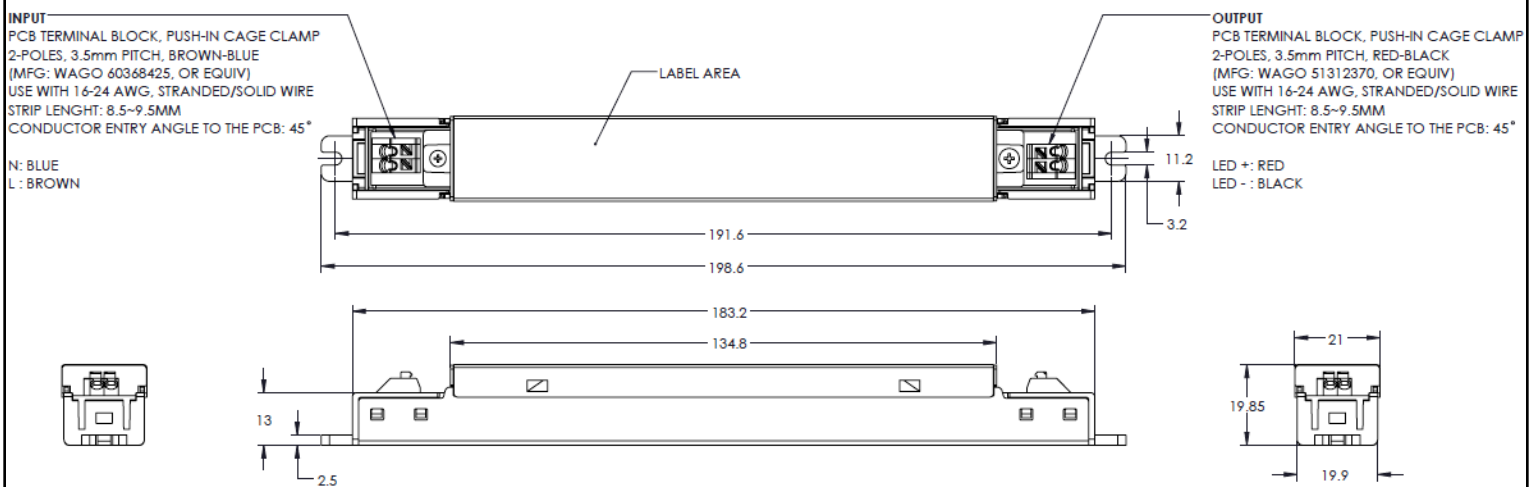

All dimensions are in mm

Figure 24

60 & 40 W, Efficient, Compact Non-Dimmable CV Class 2 / Class II LED Drivers

16 - OUTLINE DRAWINGS (MODELS WITH "-T" SUFFIX AND STRAIN RELIEFS)

Dimensions: L 241.6 x W 19.9 x H 19.85 mm (L 9.51 x W 0.78 x H 0.78 in)

TOTAL LENGTH AFTER ASSEMBLY
(VLM40/60E-T SERIES)

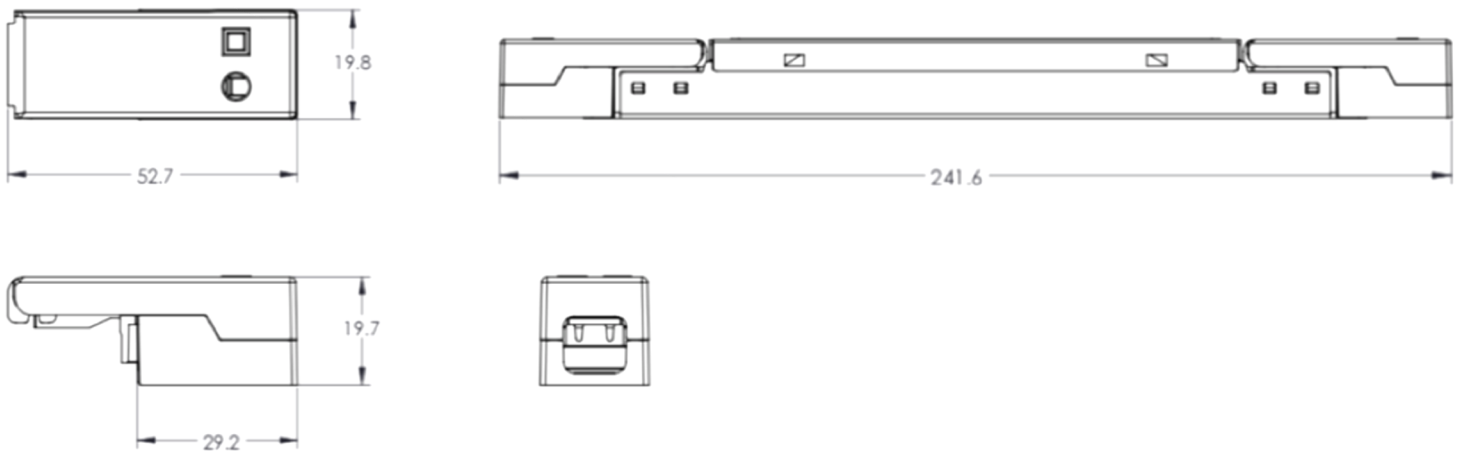

All dimensions are in mm

Figure 25

Notes:

1. Strain reliefs for "-T" models are not included and can be ordered separately using part number SR1.
2. Strain reliefs allow the driver to operate as independent control gear. This designation allows the driver to be mounted outside of the luminaire. Without strain reliefs the driver must be mounted inside the luminaire.
3. Order quantity for SR1 is per strain relief, and 2 strain reliefs are needed for each driver.
4. Additional information regarding strain reliefs can be found under the accessories section on the ERP website.

60 & 40 W, Efficient, Compact Non-Dimmable CV Class 2 / Class II LED Drivers

17 - OUTLINE DRAWINGS (MODELS WITH "-S" SUFFIX: BOTTOM LEADS AND STUDS)

Dimensions: L 130 x W 19.65 x H 23.85 mm (L 5.12 x W 0.77 x H 0.94 in)

Weight: 142 g (5.01 oz)

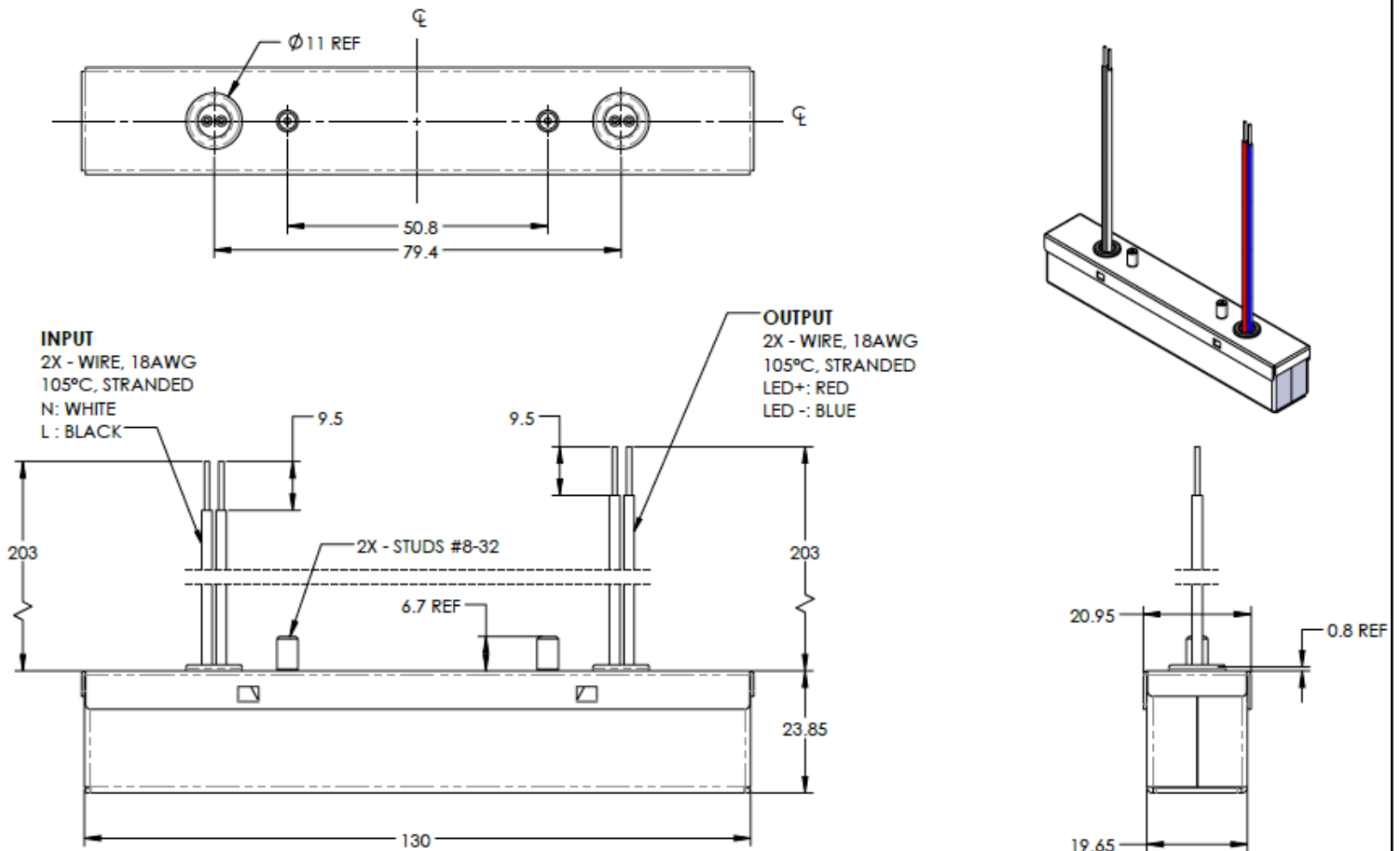

All dimensions are in mm

Figure 26



VLM60/40 Series

VLM60 60 W
VLM40 40 W

60 & 40 W, Efficient, Compact Non-Dimmable CV Class 2 / Class II LED Drivers

18 - LABELING

The VLM60W-24 and VLM60E-24-T are used in figure 27 as examples to illustrate typical labels.

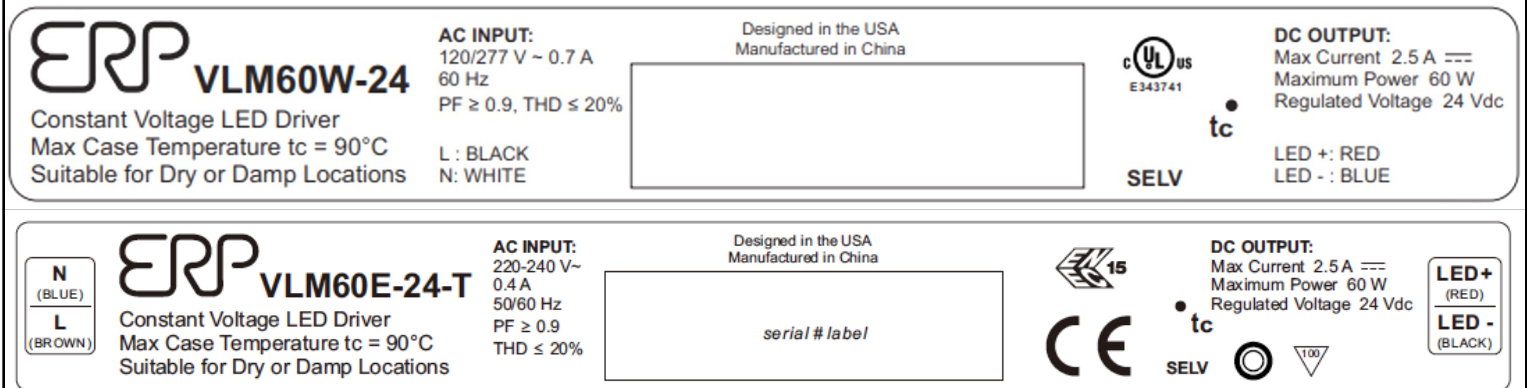

Figure 27

USA Headquarters
Tel: +1-805-517-1300
Fax: +1-805-517-1411
893 Patriot Drive, Suite E,
Moorpark, CA 93021, USA

CHINA Operations
Tel: +86-756-6266298
Fax: +86-756-6266299
No. 8 Pingdong Road 2
Zhuhai, Guangdong, China 519060

ERP Power, LLC (ERP) reserves the right to make changes without further notice to any products herein. ERP makes no warranty, representation or guarantee regarding the suitability of its products for any particular purpose, nor does ERP assume any liability arising out of the application or use of any product or circuit, and specifically disclaims any and all liability, including without limitation special, consequential or incidental damages. "Typical" parameters which may be provided in ERP data sheets and/or specifications can and do vary in different applications and actual performance may vary over time. All operating parameters, including "Typicals" must be validated for each customer application by customer's technical experts. ERP does not convey any license under its patent rights nor the rights of others. ERP products are not designed, intended, or authorized for use as components in systems intended for surgical implant into the body, or other applications intended to support or sustain life, or for any other application in which the failure of the ERP product could create a situation where personal injury or death may occur. Should Buyer purchase or use ERP products for any such unintended or unauthorized application, Buyer shall indemnify and hold ERP and its officers, employees, subsidiaries, affiliates, and distributors harmless against all claims, costs, damages, and expenses, and reasonable attorney fees arising out of, directly or indirectly, any claim of personal injury or death associated with such unintended or unauthorized use, even if such claim alleges that ERP was negligent regarding the design or manufacture of the part. ERP is an Equal Opportunity/Affirmative Action Employer. This literature is subject to all applicable copyright laws and is not for resale in any manner.



VLM60/40 Series

VLM60 60 W
VLM40 40 W

60 & 40 W, Efficient, Compact Non-Dimmable CV Class 2 / Class II LED Drivers

Revision History

Date	Comments
12FEB2019	<ul style="list-style-type: none">• Pg1: changed render files to stamped case• Added 3 pages, VLMXXE characterization curves• Pg10-13: changed MCO to stamped case
20MAR2019	<ul style="list-style-type: none">• Pg2: added strain relief order info• Pg15: added strain relief order info
09APR2019	<ul style="list-style-type: none">• Added euro flying leads MCO• Added weights
29OCT2019	<ul style="list-style-type: none">• Pg2: added compliance column
09DEC2019	<ul style="list-style-type: none">• Pg2: removed models
10MAR2020	<ul style="list-style-type: none">• Pg18: updated label image
23APR2020	<ul style="list-style-type: none">• Pg2: added strain relief information• Pg16: added additional strain relief information
30JUL2020	<ul style="list-style-type: none">• Pg1: added statement regarding VLM use• Pg3: added max number of units per circuit breaker
21SEP2020	<ul style="list-style-type: none">• Various grammar changes
22APR2021	<ul style="list-style-type: none">• Pg2: added VLM60W-36
08JUN2021	<ul style="list-style-type: none">• Pg5: changed output open load section
23MAR2023	<ul style="list-style-type: none">• Pg1: added RoHS logo