

# CBR20120PC

## SiC Schottky Diode

### Features

- Positive temperature coefficient for safe operation and ease of paralleling
- 175°C maximum operating junction temperature
- Extremely fast switching, temperature-independent
- No reverse or forward recovery
- Enhanced surge capability
- Component in accordance to ROHS

### Typical Applications

- For used in high frequency rectifier of switching mode power supplies, freewheeling diodes, dc-to-dc converters, industrial motor drives, power factor correction modules

Package type : TO220-3L

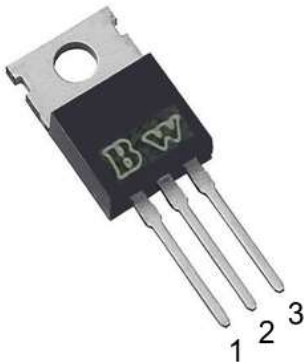

RoHS Compliant

### Graphic Symbol

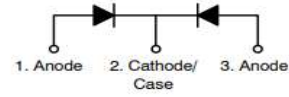

### Package Dimension

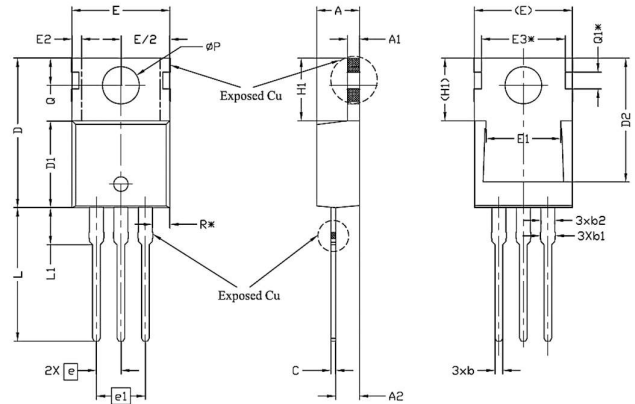

REF.	Millimeter			REF.	Millimeter		
	Min.	Nom.	Max.		Min.	Nom.	Max.
A	4.24	4.44	4.64	E2	-	-	0.76
A1	1.15	1.27	1.40	E3	8.70 REF.		
A2	2.30	2.48	2.70	e	2.54 BSC		
b	0.70	0.80	0.90	e1	5.08 BSC		
b1	1.20	1.55	1.75	H1	6.30	6.45	6.60
b2	1.20	1.45	1.70	L	13.47	13.72	13.97
c	0.40	0.50	0.60	L1	3.60	3.80	4.00
D1	14.70	15.37	16.00	ØP	3.75	3.84	3.93
D1	8.82	8.92	9.02	Q	2.60	2.80	3.00
D2	12.43	12.73	12.83	Q1	1.73 REF.		
E1	9.96	10.16	10.36	R	1.82 REF.		
E1	6.86	7.77	8.89				

### Marking

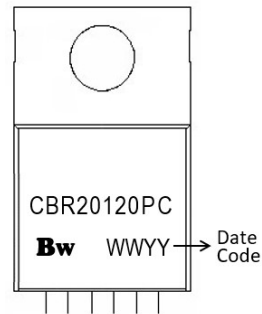

## CBR20120PC

### SiC Schottky Diode

#### MAXIMUM RATINGS AND ELECTRICAL CHARACTERISTICS

Absolute Maximum Ratings (T <sub>c</sub> =25°C unless otherwise noted)			
Symbol	Parameter	Value	Unit
V <sub>RRM</sub>	Maximum repetitive reverse voltage	1200	V
I <sub>F</sub>	Maximum average forward rectified current @ T <sub>c</sub> =25°C	20 <sup>1</sup> / 32 <sup>2</sup>	A
	Maximum average forward rectified current @ T <sub>c</sub> =100°C	10 <sup>1</sup> / 20 <sup>2</sup>	A
I <sub>FSM</sub>	Peak forward surge current (tp=8.3ms) @ T <sub>c</sub> =25°C	66	A
	Peak forward surge current (tp=8.3ms) @ T <sub>c</sub> =110°C	37	A
I <sub>FRM</sub>	Repetitive peak forward surge current (tp=8.3ms) @ T <sub>c</sub> =25°C	32	A
	Repetitive peak forward surge current (tp=8.3ms) @ T <sub>c</sub> =110°C	19	A
I <sub>F Max</sub>	Non-repetitive peak forward current (tp=10μs) @ T <sub>c</sub> =25°C	315	A
P <sub>tot</sub>	Power Dissipation	60	W
T <sub>J</sub> /T <sub>STG</sub>	Operating Junction and Storage Temperature	-55 to 175	°C

Thermal Resistance Ratings			
Symbol	Parameter	Value	Unit
R <sub>θJC</sub>	Maximum Junction-to-Case Thermal Resistance	2.5 <sup>1</sup> / 1.5 <sup>2</sup>	°C/W

Electrical Characteristics(T <sub>J</sub> =25°C unless otherwise specified)					
Symbol	Parameter	Test Conditions	Typ.	Max.	Unit
V <sub>F</sub>	Instantaneous forward voltage	I <sub>F</sub> =10A, T <sub>J</sub> =25°C	1.5	1.7	V
		I <sub>F</sub> =10A, T <sub>J</sub> =175°C	2.2	3	
I <sub>R</sub>	Maximum reverse current	V <sub>R</sub> =1200V, T <sub>J</sub> =25°C	1	100	μA
		V <sub>R</sub> =1200V, T <sub>J</sub> =175°C	42	300	
C	Total Capacitance	V <sub>R</sub> =0.1V	620	-	pF
		V <sub>R</sub> =400V	56	-	
		V <sub>R</sub> =800V	41	-	
Q <sub>C</sub>	Total Capacitive charge	V <sub>R</sub> =800V, I <sub>F</sub> =10A, di/dt=250A/μs	50	-	nC
				-	

**Note:**

1. Per leg
2. Per device

## CBR20120PC

### SiC Schottky Diode

#### Typical Electrical Characteristics

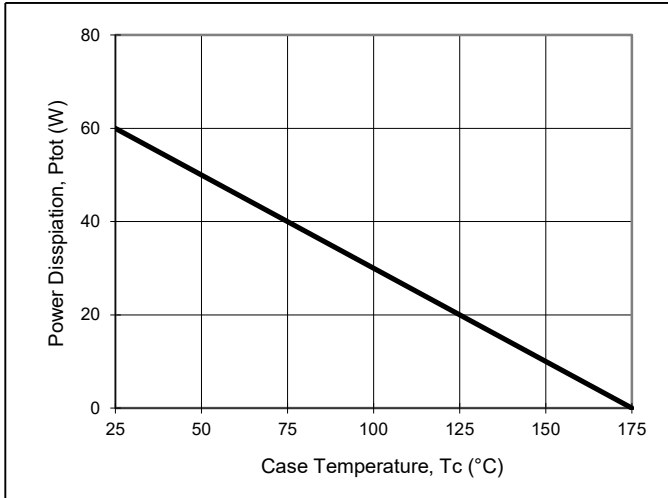

**Fig1. Power Dissipation**

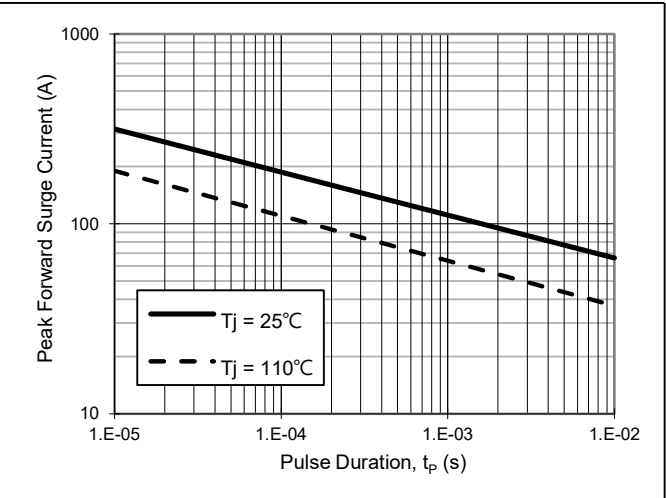

**Fig2. Non-repetitive peak forward current vs.  $t_p$**

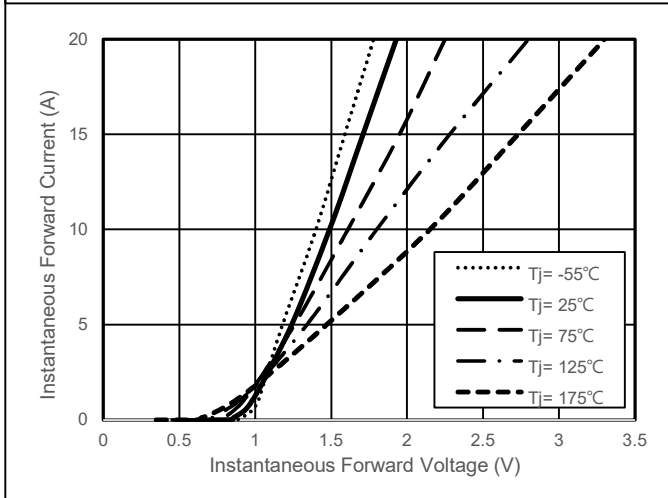

**Fig3. Typical Forward Characteristics**

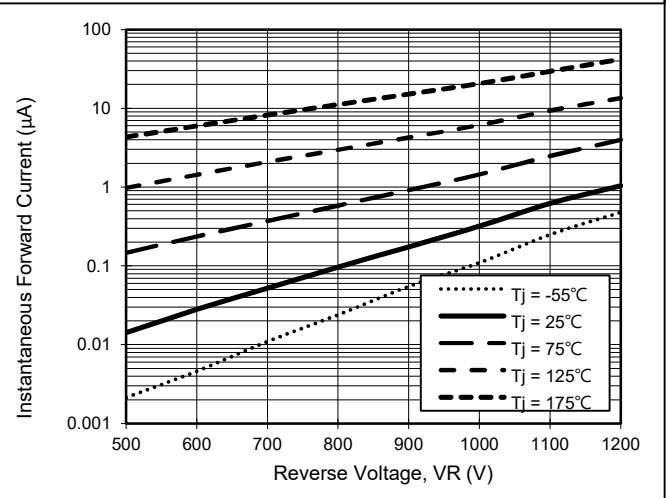

**Fig4. Typical Reverse Characteristics**

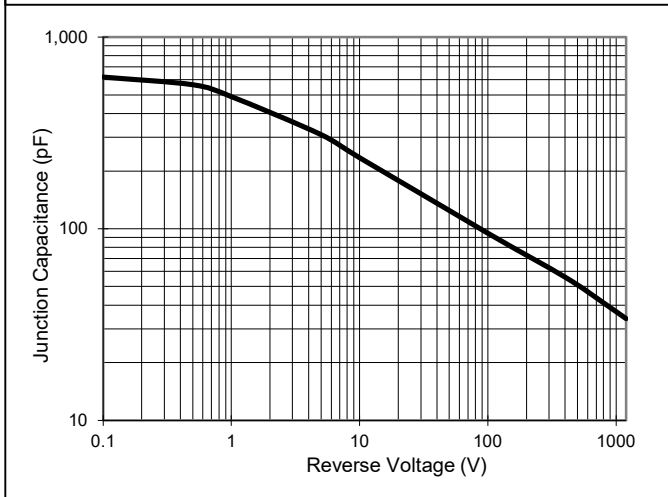

**Fig5. Typical Junction Capacitance**

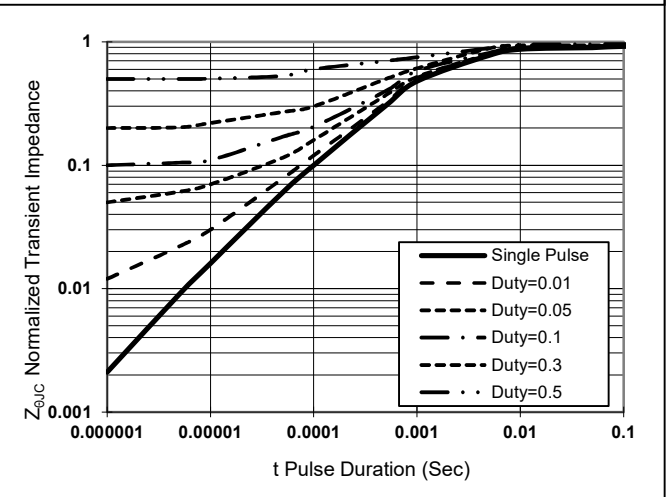

**Fig6. Transient Thermal Impedance**

## CBR20120PC

### SiC Schottky Diode

#### Disclaimer

ALL PRODUCT, PRODUCT SPECIFICATIONS AND DATA ARE SUBJECT TO CHANGE WITHOUT NOTICE TO IMPROVE RELIABILITY, FUNCTION OR DESIGN OR OTHERWISE.

Bruckewell Technology Inc., its affiliates, agents, and employees, and all persons acting on its or their behalf (collectively, "Bruckewell"), disclaim any and all liability for any errors, inaccuracies or incompleteness contained in any datasheet or in any other disclosure relating to any product.

Bruckewell makes no warranty, representation or guarantee regarding the suitability of the products for any particular purpose or the continuing production of any product. To the maximum extent permitted by applicable law, Bruckewell disclaims

- (i) Any and all liability arising out of the application or use of any product.
- (ii) Any and all liability, including without limitation special, consequential or incidental damages.
- (iii) Any and all implied warranties, including warranties of fitness for particular purpose, non-infringement and merchantability.

Statements regarding the suitability of products for certain types of applications are based on Bruckewell's knowledge of typical requirements that are often placed on Bruckewell products in generic applications.

Such statements are not binding statements about the suitability of products for a particular application. It is the customer's responsibility to validate that a particular product with the properties described in the product specification is suitable for use in a particular application. Parameters provided in datasheets and/or specifications may vary in different applications and performance may vary over time.

Product specifications do not expand or otherwise modify Bruckewell's terms and conditions of purchase, including but not limited to the warranty expressed therein.