

ECI motor.

ECI-42.XX-K1



- Highly dynamic 3-phase internal rotor motor with EC technology
- Low cogging torque
- Robust, noise-optimized ball bearing system for a long service life
- High efficiency and high power density realized in a compact design
- Basic motor with electronic module K1 for operation with external control electronics
- Mechanical design and interfaces designed for modular flexibility
- Protection class IP 40 (higher on request) and connection by wires

Nominal data					
Type		ECI-42.20-K1-B00	ECI-42.20-K1-D00	ECI-42.40-K1-B00	ECI-42.40-K1-D00
Nominal voltage (U_n)	V DC	24	48	24	48
Nominal speed (n_n)**	rpm	4 000			
Nominal torque (M_n)**	mNm	110	110	220	220
Nominal current (I_n)**	A	2.50	1.30	5.10	2.60
Nominal output power (P_n)**	W	46	46	92	92
Starting torque (M_{max})	mNm	480	480	960	960
Permissible peak current (I_{max})***	A	14	7	21	11
Speed at no-load operation (n_0)	rpm	5 900	5 900	5 700	5 700
No-load current (I_0)	A	0.33	0.10	0.40	0.20
Permanent stall torque (M_{st})	mNm	100	100	200	200
Recommended speed control range	rpm	0 ... 5 000			
Rotor moment of inertia (J_r)	kgm ² x10 ⁻⁶	3.42	3.42	6.70	6.70
Motor constant (K_E)	mVs/rad	40.9	84.2	42.8	83.9
Connection resistance (R_v)	Ω	0.85	3.20	0.39	1.50
Connection inductance (L_v)	mH	1.10	4.50	0.50	1.84
Overload protection	To be implemented via the control electronics				
Permissible ambient temperature range (T_U)	$^{\circ}\text{C}$	0 ... +40			
Weight	kg	0.33	0.33	0.48	0.48
Order no. (wire interface)*	IP 40	932 4220 122	932 4220 123	932 4240 122	932 4240 123
Subject to alterations	* Classification of protection class refers to installed state with sealing on the flange side ** At T_U max. 40 $^{\circ}\text{C}$ *** Permissible time for peak current: max. 1 sec. – to be repeated only after complete cool down				

Characteristic curve

ECI-42.20, 24 V (at 25 $^{\circ}\text{C}$)

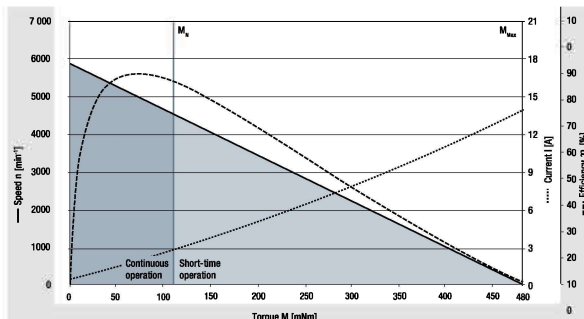

¹⁾ Nominal data, see table

Characteristic curve 48 V on request

ECI-42.40, 24 V (at 25 $^{\circ}\text{C}$)

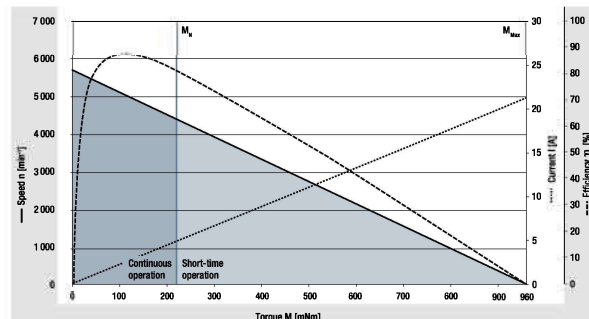

¹⁾ Nominal data, see table

Characteristic curve 48 V on request

Technical drawing

All dimensions in mm

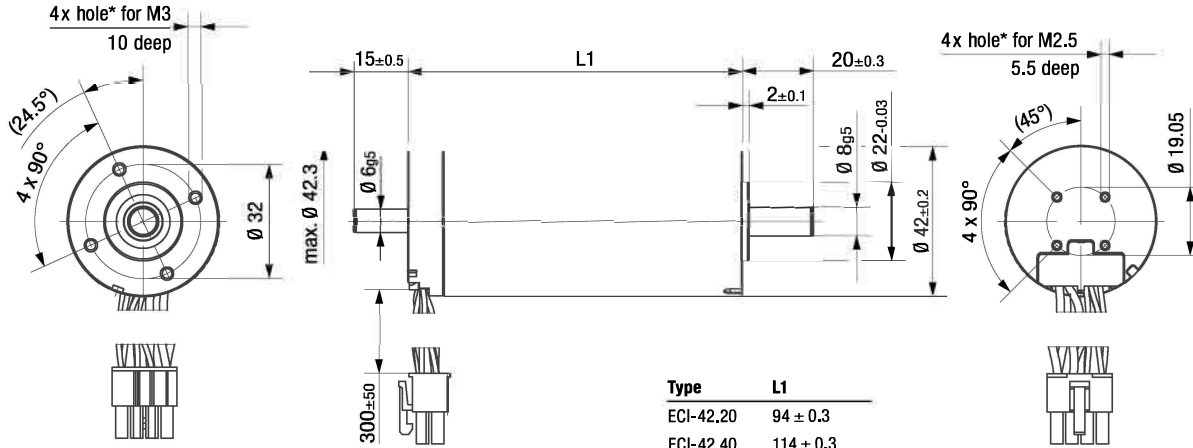

Type	L1
ECI-42.20	94 ± 0.3
ECI-42.40	114 ± 0.3

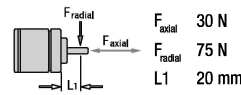

30 N Permissible shaft load at nominal speed and life expectancy L_{10} (nominal operation) of 20 000 h (at T_v max. 40°C)

75 N

20 mm

* For thread-rolling screws according to DIN 7500

Electrical connection

Supply wire

No.	Color	Function
1	yellow	Phase W
5	violet	Phase V
6	brown	Phase U

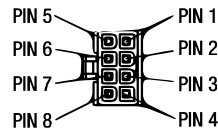

Molex pin no. 39-01-2085

Signal wire

No.	Color	Function
4	green	Hall A
3	white	Hall B
8	gray	Hall C
2	red	U_B
7	black	GND

Modular construction kit

Brake system

Spring-applied brake
BFK 457-01 (page 76)



Basic motor



Planetary gearheads

NoiselessPlus 42 (page 50)
Performax® 42 (page 54)
Performax®Plus 42 (page 58)



Encoder system

Optical incremental encoder
HEDS 5500 (page 78)



Recommended external control electronics

VTD-XX.XX-K3	Speed (page 38)
VTD-XX.XX-K4S	Position (page 40)
VTD-60.13-K5SB	Position (page 42)



Crown gearheads

EtaCrown® 52 (page 64)
EtaCrown®Plus 42 (page 68)



For motor-gearbox combinations, depending on the choice of the single components, the maximum allowable torque (gearbox) can be exceeded or respectively not reached.

Crown gearheads.

EtaCrown® 52



Image of 2-stage gearhead

- Maximum safety in design and operation, as well as optimal vandalism protection; no automatic lock due to high efficiency of the crown wheel technology
- Space-saving installation due to zero offset axle and symmetrical structure
- Flexible application possibilities with various optional shaft outlets and available shaft geometries
- Wide reduction range by means of upstream / downstream planetary stage
- High radial loads due to double ball bearing in the output shaft

Nominal data		EtaCrown® 52.1			EtaCrown® 52.2			
Gearheads								
Reduction ratio		4.10	6.70	10.1	21.2	33.3	60.0	113
No. of stages		1			2			
Efficiency		0.90			0.81			
Max. input speed (n _i)	rpm	6 000			6 000			
Rated output torque (M _{ab})	Nm	0.21	0.34	0.52	0.98	1.54	2.77	3.48
Short-term torque (M _{max})	Nm	0.53	0.85	1.30	2.45	3.85	6.93	8.70
Gear play	°	0.55 ... 1.1			0.55 ... 1.1			
Permissible operating temperature (T _v)	°C	-20 ... +80			-20 ... +80			
Operating mode		S1			S1			
Protection class		IP 50			IP 50			
Weight	kg	0.40			0.65			
Shaft load radial / axial	N	300 / 150	350 / 150	400 / 150	500 / 150	570 / 150	720 / 150	770 / 150
Service life	h	5 000			5 000			
Lubrication		Maintenance-free grease lubrication for life						
Installation position		any						
Subject to alterations		on request						

Technical drawing

Image of 1-stage gearhead with left shaft end (W05) / All dimensions in mm

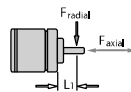
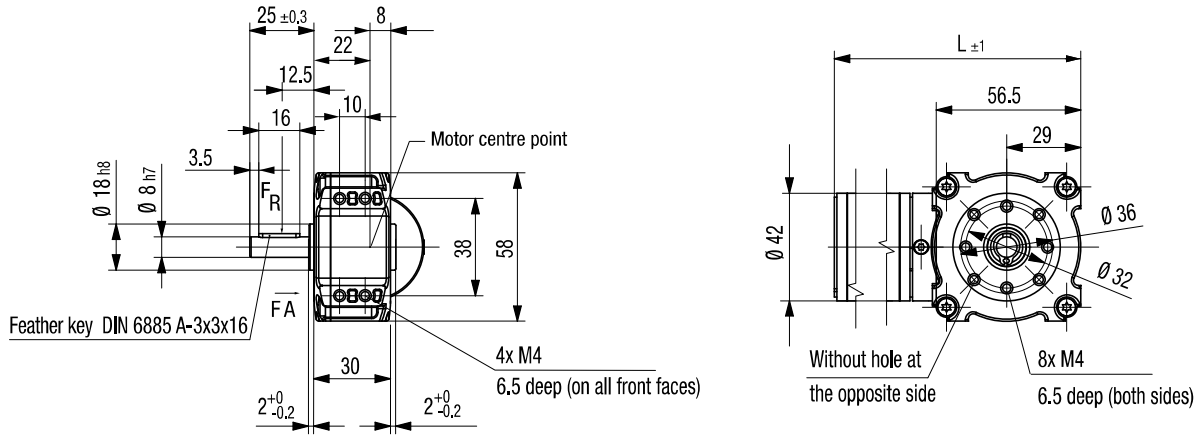

F_{axial} 150 N
 F_{radial} see table
 L1 12.5 mm

Permissible shaft load at nominal speed and life expectancy L_{10} (nominal operation) and operating factor $C_b = 1$ (see page 82) of 5 000 h (at $T_v 40^\circ C$).

Shaft end, right (W05) (standard)	Shaft end, left (W06)	Shaft end, both sides (W07)

Length of the possible motor / gearhead combinations

Motor / gearhead		L - 1-stage	L - 2-stage
ECI-42.20-K1-E52	mm	160	189
ECI-42.40-K1-E52	mm	180	209

Subject to alterations