



SPECIFICATION SHEET

SPECIFICATION SHEET NO.	Q0721- TO220FMD12N65F
DATE	July. 21, 2023
REVISION	A0
DESCRIPTION	SMD Plastic-Encapsulate MOSFETS, TO -220F series, 3 Pins MDD12N65F Type, 650V N-Channel Enhancement Mode MOSFET Drain-Source Voltage: 650V, Continuous Drain Current 12A Junction Temperature: +150°C, Package in Tape/Reel, 50pcs/Tube RoHS/RoHS III compliant
CUSTOMER	
CUSTOMER PART NUMBER	
CROSS REF. PART NUMBER	
ORIGINAL PART NUMBER	MDD12N65F
PART CODE	TO220FMD12N65F

VENDOR APPROVE			
Issued/Checked/Approved			
DATE: July. 21, 2023			

CUSTOMER APPROVE	
DATE:	
7/21/2023	

SMD PLASTIC-ENCAPSULATE MOSFETS TO-220F SERIES

MAIN FEATURE

- Ultra Low Gate Charge
- Low Reverse Transfer Capacitance
- Fast Switching Capability
- Avalanche Energy Tested
- Improved dv/dt Capability and High Ruggedness



APPLICATION

- High Efficiency Switch Mode Power Supplies
- Electronic Lamp Ballasts Based On Half Bridge
- LED Power Supplies

RFQ

[Request For Quotation](#)

PART CODE GUIDE

TO220F	MD	12N65	F
1	2	3	4

- 1) **TO220F**: SMD Plastic-Encapsulate MOSFETS, TO-220F series, 3 pins
- 2) **MD**: Original Supplier Code
- 3) **12N65**: Main Specification code for I_D: 12A , N: N-Channel and V_{DS} : 650V
- 4) **F**: Internal Control Code, (A~Z or 1~9 or Blank) or custom parametric data

SMD PLASTIC-ENCAPSULATE MOSFETS TO-220F SERIES

DIMENSION (Unit: Inch/mm)

Image for reference

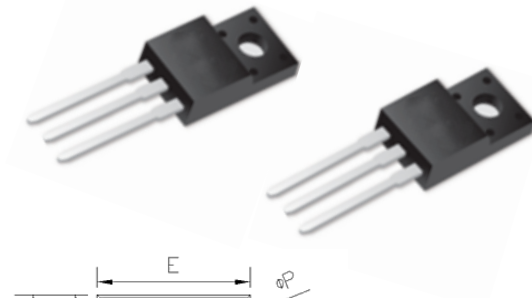

Marking: 12N65F

TO-220F-3L

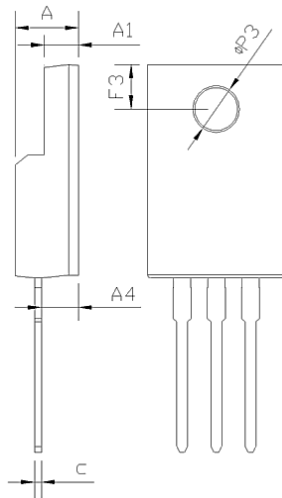
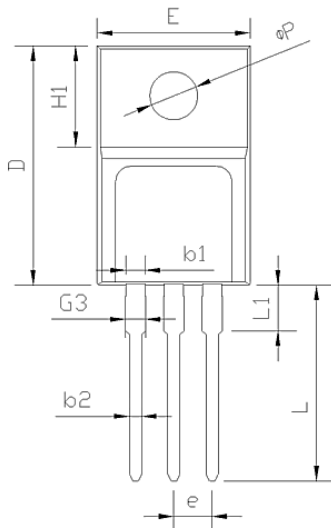

Symbol	Value (mm)		
	Min.	Typ.	Max.
E	9.96	10.16	10.36
A	4.50	4.70	1.90
A1	2.34	2.54	2.74
A4	2.56	2.76	2.96
c	0.40	0.50	0.65
D	15.57	15.87	16.17
H1	6.70 REF		
e	2.54 BSC		
L	12.68	12.98	13.28
L1	2.88	3.03	3.18
ϕP	3.03	3.18	3.38
ϕP3	3.15	3.45	3.65
F3	3.15	3.30	3.45
G3	1.25	1.35	1.55
b1	1.18	1.28	1.43
b2	0.70	0.8	0.95

EQUIVALENT CIRCUIT DIAGRAM

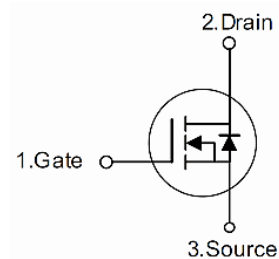
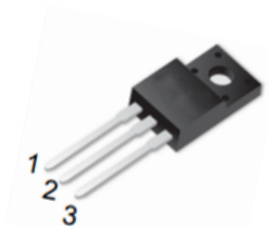

SMD PLASTIC-ENCAPSULATE MOSFETS TO-220F SERIES
650V N-CHANNEL ENHANCEMENT MODE MOSFET

V (BR)DSS	I D (TC+ 25°C)	R DS (on),max	Q g,typ
650V	12A	0.8 Ω @ VGS=10V	41.9 nC

ABSOLUTE MAX. RATINGS AT (Ta=25 °C unless otherwise specified)

Parameter	SYMBOLS	VALUE	UNIT
Drain-Source Voltage	V DS	650	V
Gate-Source Voltage	V GS	±30	V
Continuous Drain Current	I D	12	A
Pulsed Drain Current(Note 1)	I D	48	A
Avalanche Energy Single Pulsed (Note 2)	E AS	500	mJ
Continuous diode forward current	I S	12	A
Diode pulse current	I S,pulse	48	A
Peak Diode Recovery dv/dt (Note 3)	dv/dt	5.0	V/ns
Power Dissipation (TO-220F)	P D	42	W
Junction Temperature	T J	+150	°C
Storage Temperature Range	T STG	-55 ~ +150	°C

THERMAL CHARACTERISTICS

Parameter	SYMBOLS	VALUE (TO-220F)	UNIT
Thermal resistance, Junction-to-case	R θJC	2.98	°C/W
Thermal resistance, Junction-to-ambient	R θJA	110	°C/W

Notes:

1. Pulse width limited by maximum junction temperature. 2. L=10mH, I AS = 10A, Starting T j= 25°C.
3. I SD = 12A, di/dt≤100A/us, VDD≤BVDS, Starting Tj= 25°C.

SMD PLASTIC-ENCAPSULATE MOSFETS TO-220F SERIES
MOSFET ELECTRICAL CHARACTERISTICS AT Ta=25 °C (unless otherwise specified)

Parameter		SYMBOLS	VALUE			UNIT	Condition
			Min.	Typ.	Max.		
Drain-Source Breakdown Voltage		V (BR) DSS	650	-	-	V	VGS=0V I D=250μA
Gate-Source Leakage Current	Forward	I GSS	-	-	100	nA	VGS=30V, VDS=0V
	Reverse		-	-	-100	nA	VGS=-30V, VDS=0V
Drain-Source Leakage Current		I DSS	-		1	μA	VDS=650V, VGS=0V
Gate Threshold Voltage		V GS(TH)	2.0	-	4.0	V	VDS=VGS, ID=250μA
Drain-Source On-State Resistance		R DS (ON)	-	0.64	0.8	Ω	VGS=10V, IDS=6A

DYNAMIC ELECTRICAL CHARACTERISTICS

Parameter		SYMBOLS	VALUE			UNIT	Condition
			Min.	Typ.	Max.		
Input Capacitance		C iss	-	2000	-	pF	V DS=25V V GS=0V f =1MHz
Output Capacitance		C oss	-	164	-		
Reverse Transfer Capacitance		C rss	-	7.4	-		
Total Gate Charge		Q g	-	41.9	-	nC	VDS=520V ID=12A VGS=10V (Note1, 2)
Gate Source Charge		Q gs	-	10.8	-		
Gate Drain Charge		Q gd	-	15			

SMD PLASTIC-ENCAPSULATE MOSFETS TO-220F SERIES
SWITCHING CHARACTERISTICS

Parameter	SYMBOLS	VALUE			UNIT	Condition
		Min.	Typ.	Max.		
Turn on Delay Time	t _{d(on)}	-	-	14.16	ns	V _{DD} =325V I _D =12A R _G = 10Ω (Note 1, 2)
Turn on Rise Time	t _r	-	-	37.8		
Turn Off Delay Time	t _{d(off)}	-	-	39.3		
Turn Off Fall Time	t _f	-	-	15.8		

SOURCE DRAIN DIODE CHARACTERISTICS

Parameter	SYMBOLS	VALUE			UNIT	Condition
		Min.	Typ.	Max.		
Source drain current (Body Diode)	I _{SD}	-	-	12	A	
Pulsed Current	I _{SM}	-	-	48	A	
Drain-Source Diode Forward Voltage	V _{SD}	-	-	1.5	V	I _S =12A, V _{GS} =0V
Body Diode Reverse Recovery Time	t _{rr}	-	450.4	-	ns	V _R =325 V I _F =12A, -diF/dt =100A/μs
Body Diode Reverse Recovery Charge	Q _{rr}	-	4.75	-	uC	

Notes:

1. Pulse test ; Pulse width ≤ 300us, duty cycles ≤ 2%. 2. Essentially independent of operating temperature.

SMD PLASTIC-ENCAPSULATE MOSFETS TO-220F SERIES

ELECTRICAL CHARACTERISTICS DIAGRAMS (For Reference Only)

Figure 1. Typical Output Characteristics

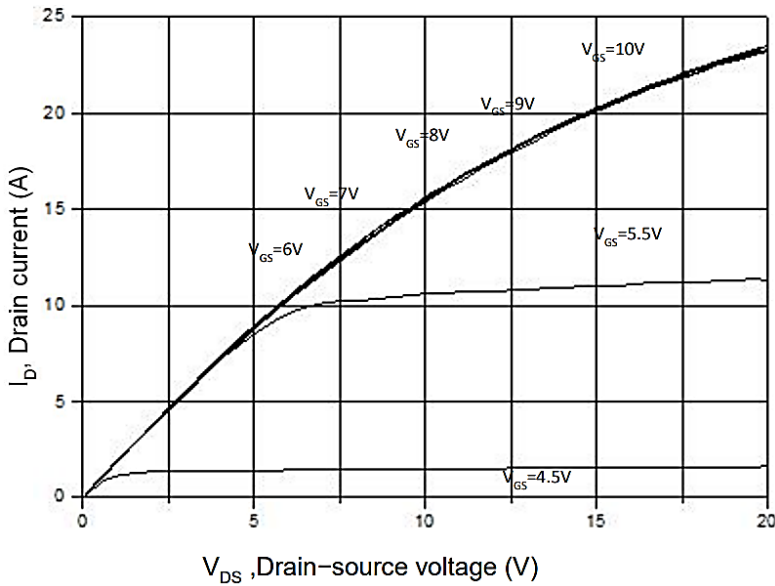
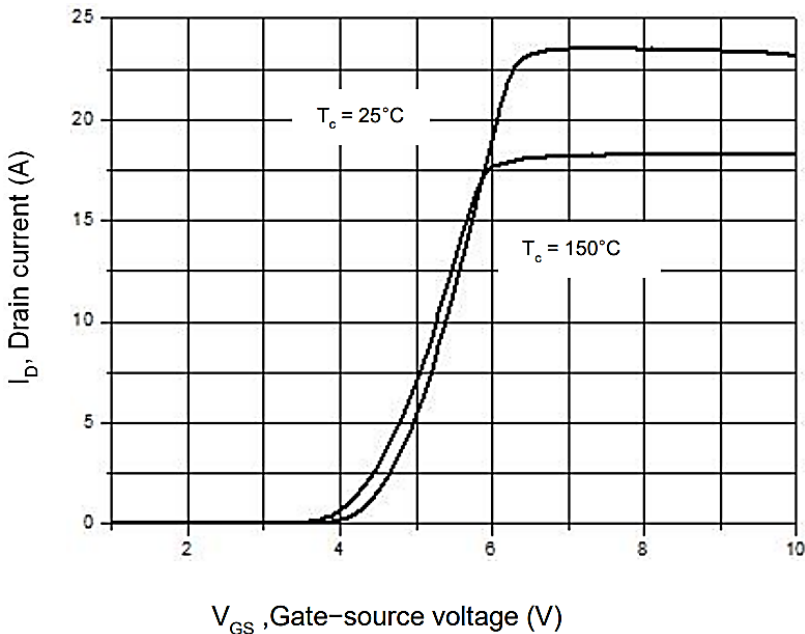

Figure 2. Transfer Characteristics



SMD PLASTIC-ENCAPSULATE MOSFETS TO-220F SERIES

ELECTRICAL CHARACTERISTICS DIAGRAMS (For Reference Only)

Figure 3. On-Resistance Variation vs. Drain Current

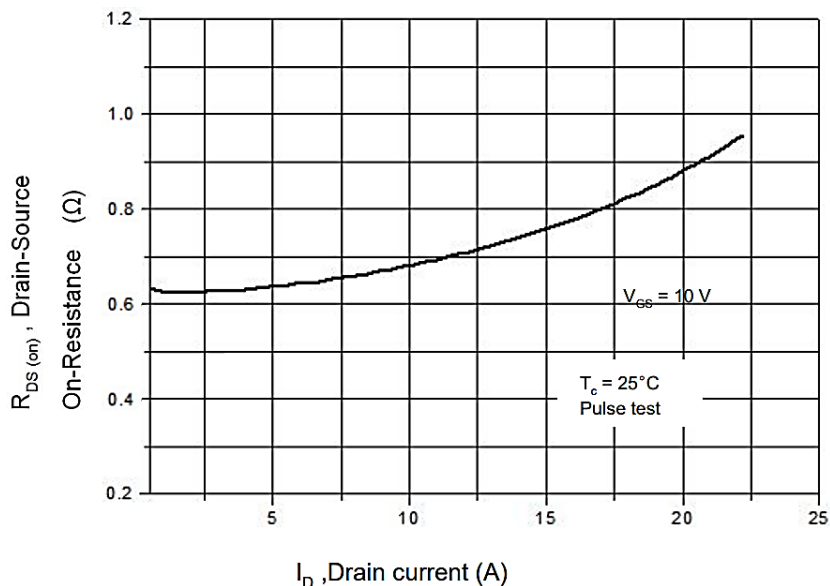
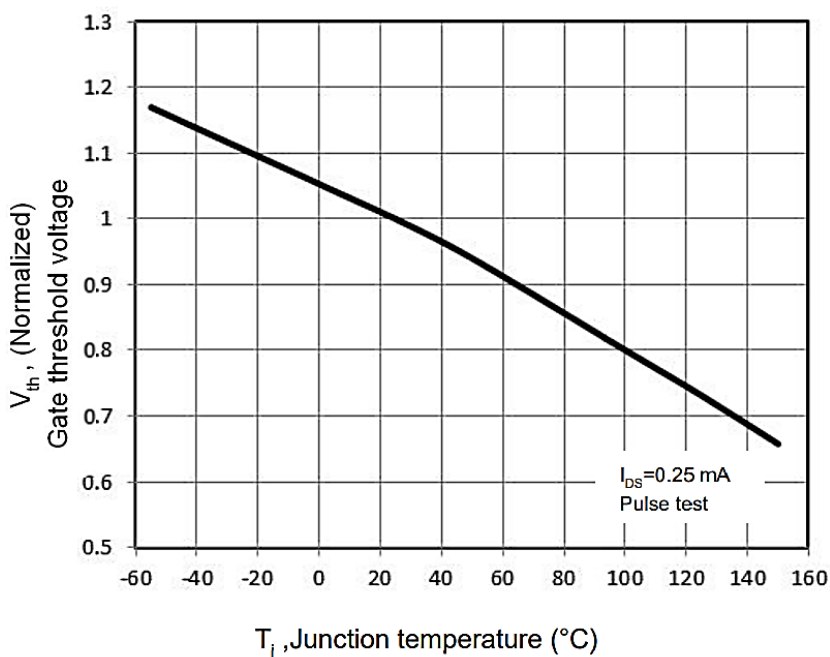

Figure 4. Threshold Voltage vs. Temperature



SMD PLASTIC-ENCAPSULATE MOSFETS TO-220F SERIES

ELECTRICAL CHARACTERISTICS DIAGRAMS (For Reference Only)

Figure 5. Breakdown Voltage vs. Temperature

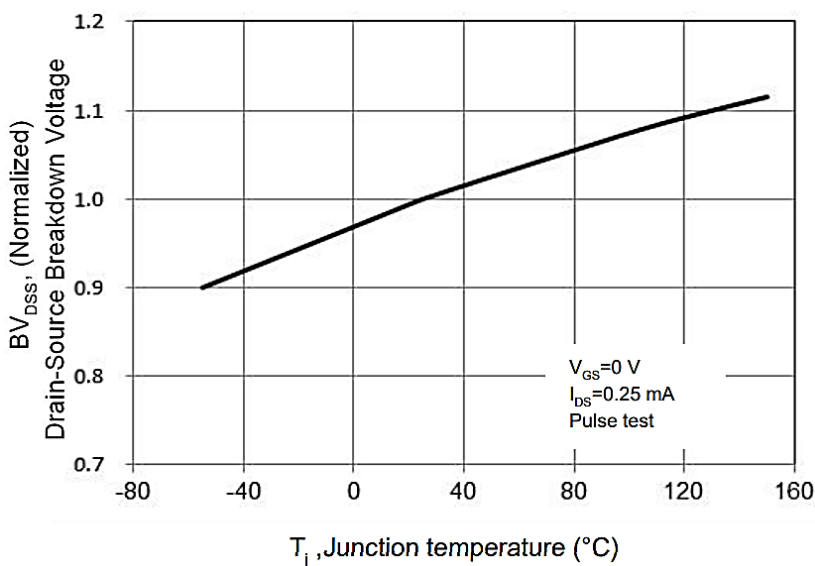
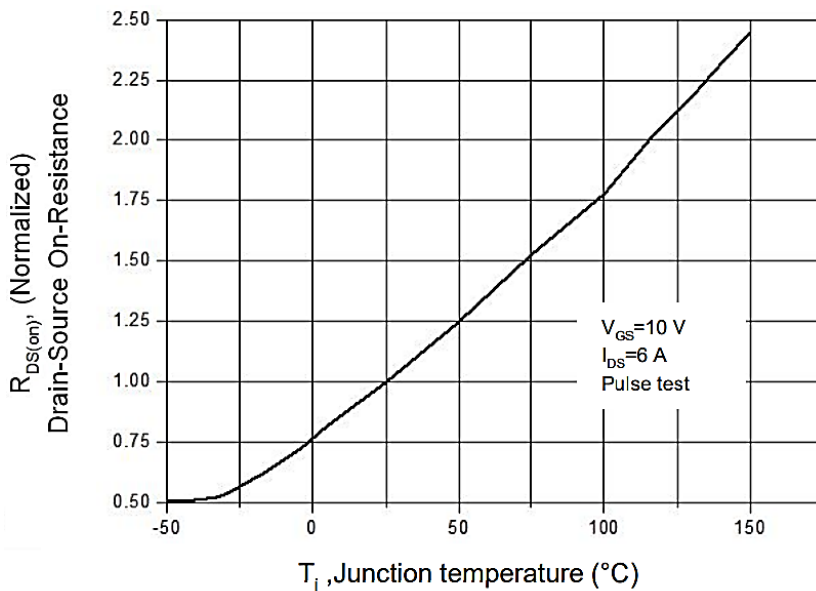

Figure 6. On-Resistance vs. Temperature



SMD PLASTIC-ENCAPSULATE MOSFETS TO-220F SERIES

ELECTRICAL CHARACTERISTICS DIAGRAMS (For Reference Only)

Figure 7. Capacitance Characteristics

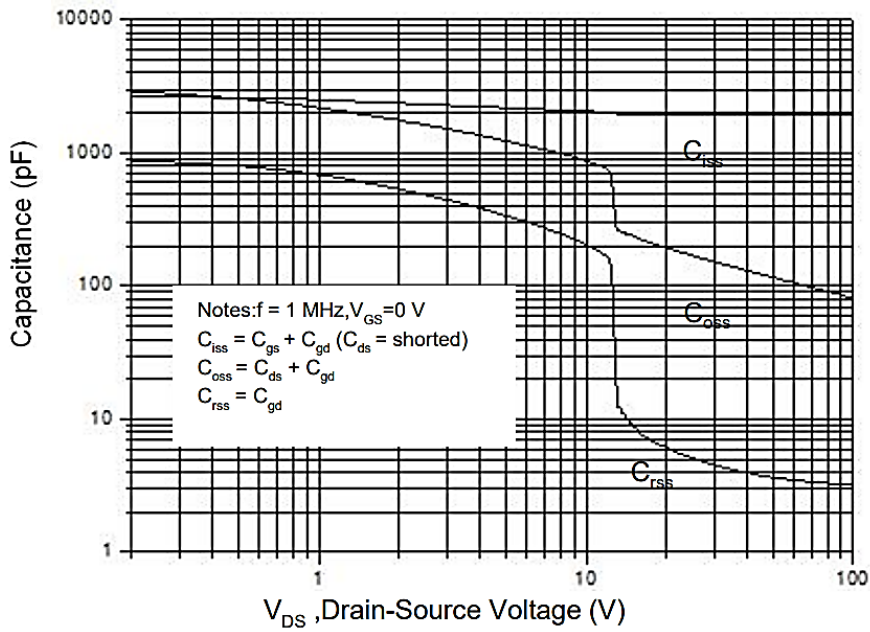
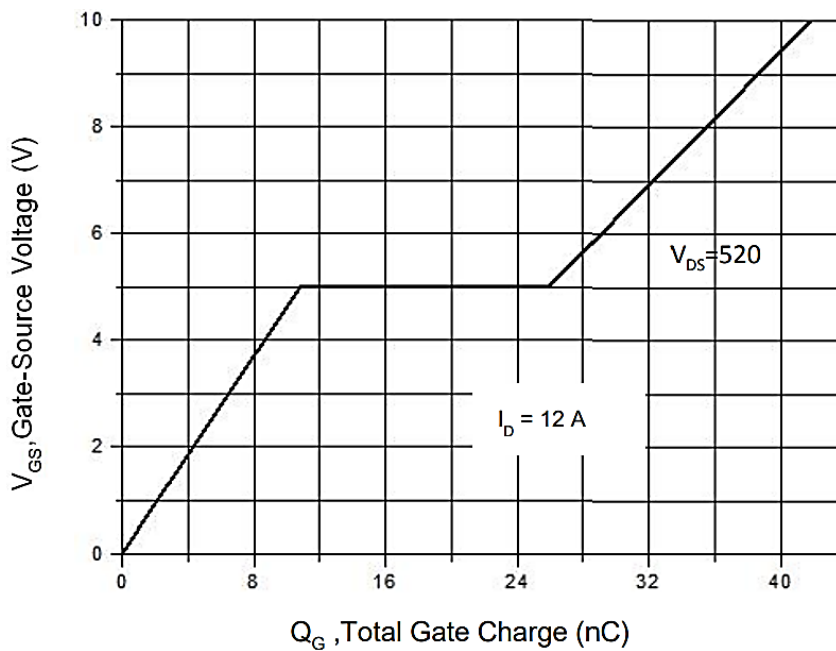

Figure 8. Gate Charge Characterist



SMD PLASTIC-ENCAPSULATE MOSFETS TO-220F SERIES

ELECTRICAL CHARACTERISTICS DIAGRAMS (For Reference Only)

Figure 9. Maximum Safe Operating

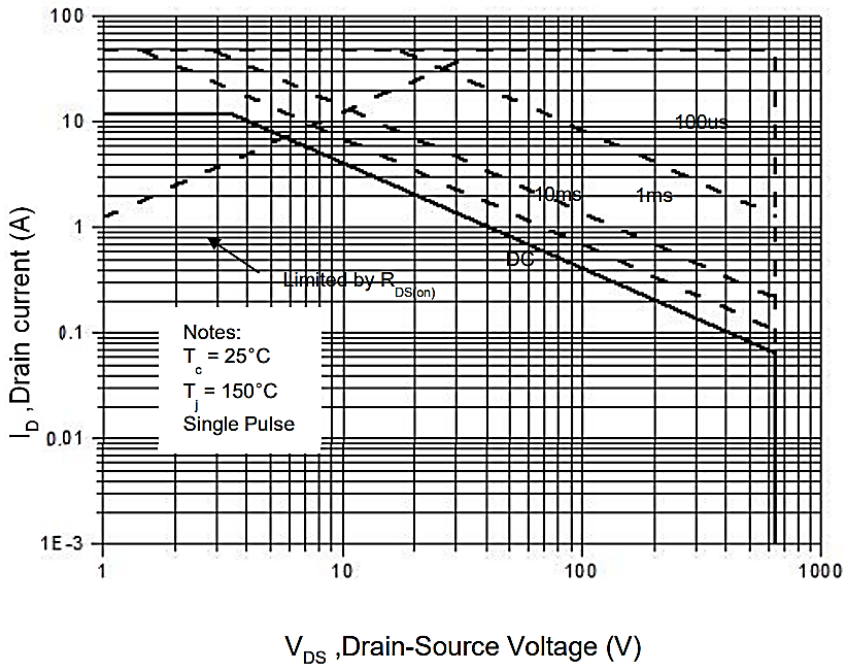
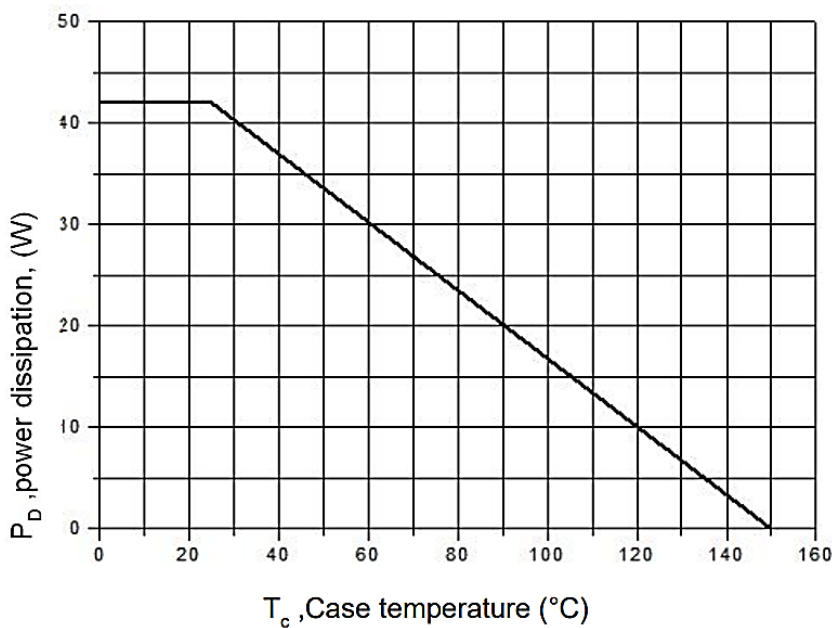

Figure 10. Power Dissipation vs. Temperature



SMD PLASTIC-ENCAPSULATE MOSFETS TO-220F SERIES

ELECTRICAL CHARACTERISTICS DIAGRAMS (For Reference Only)

Figure 11. Continuous Drain Current vs. Temperature

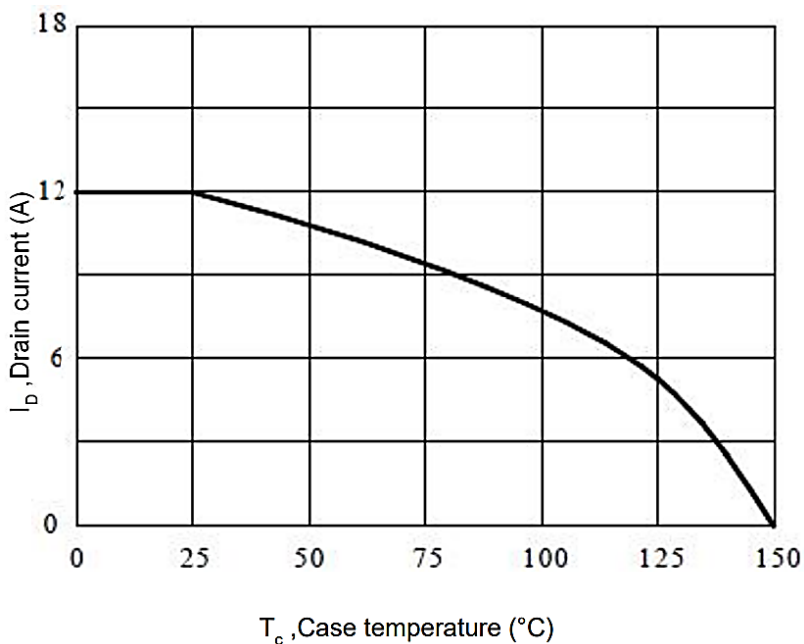
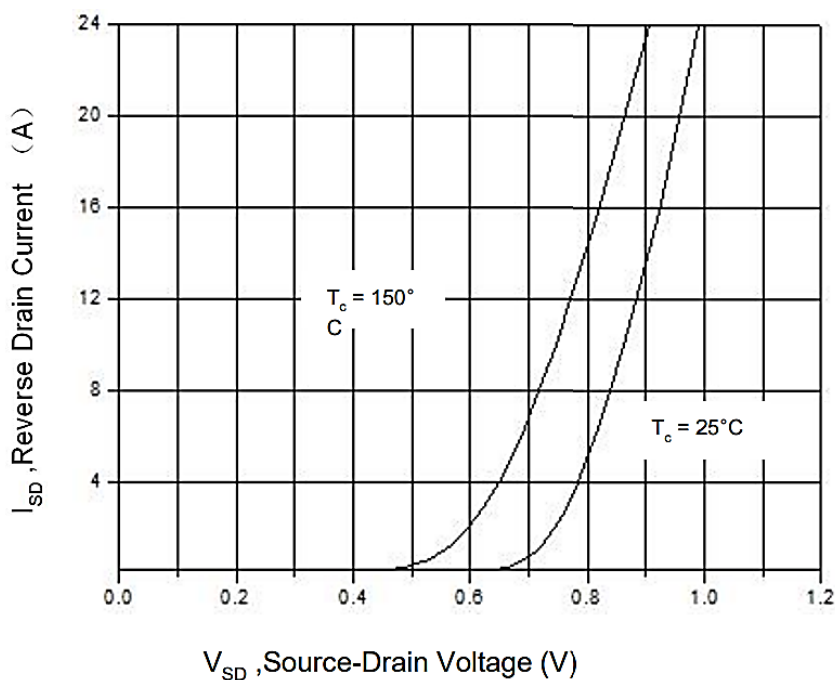

Figure 12. Body Diode Transfer Characteristics



SMD PLASTIC-ENCAPSULATE MOSFETS TO-220F SERIES

ELECTRICAL CHARACTERISTICS DIAGRAMS (For Reference Only)

Figure 13. Transient Thermal Impedance, Junction to Case,

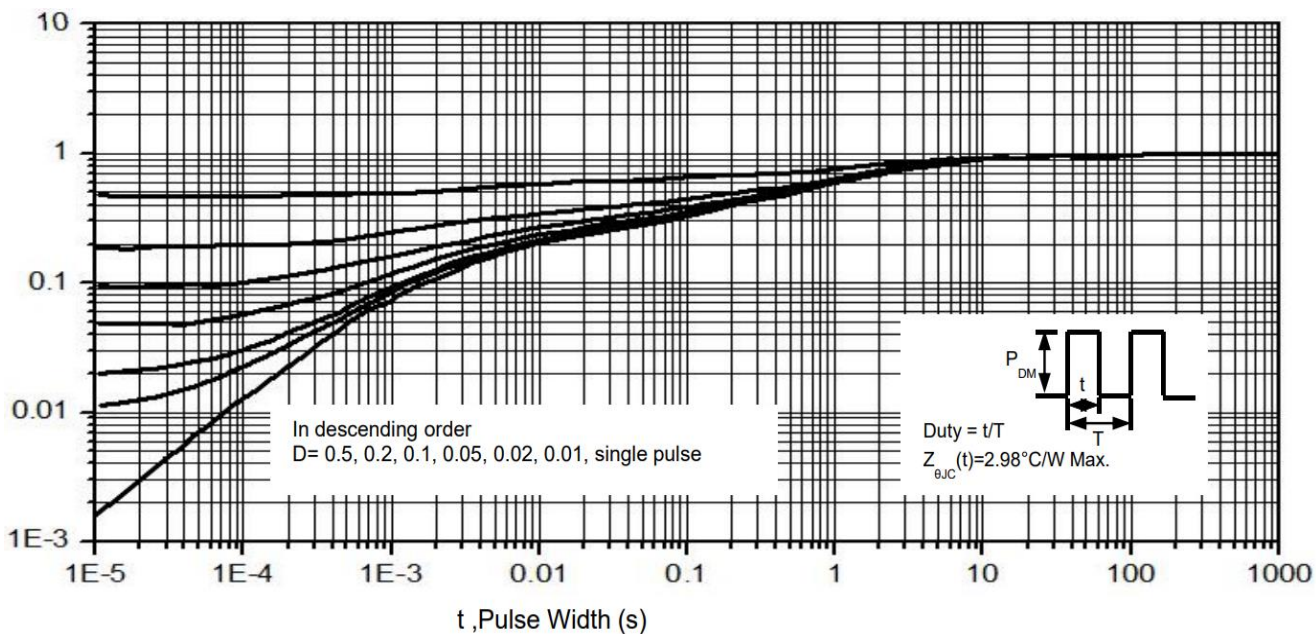

SMD PLASTIC-ENCAPSULATE MOSFETS TO-220F SERIES

TEST CIRCUIT AND WAVEFORMS CURVE (For Reference Only)

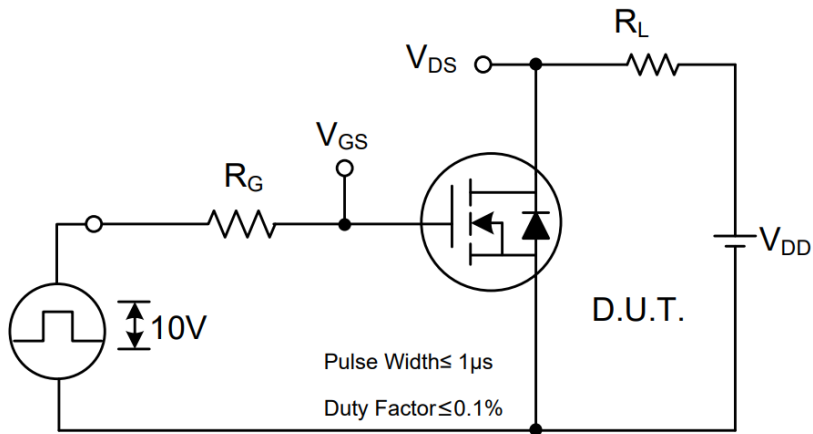

Switching Test Circuit

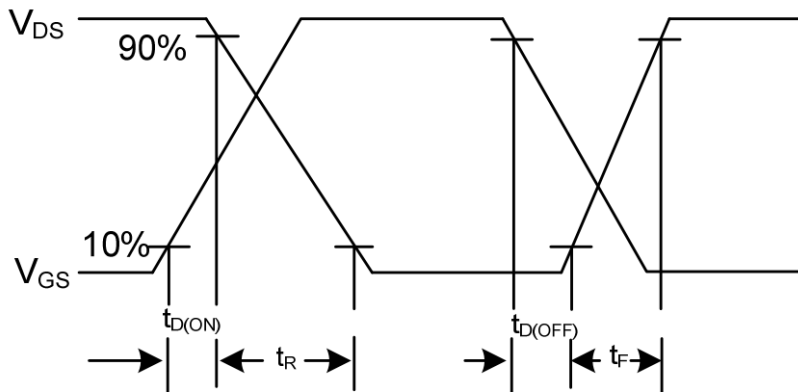

Switching Waveforms

SMD PLASTIC-ENCAPSULATE MOSFETS TO-220F SERIES

TEST CIRCUIT AND WAVEFORMS CURVE (For Reference Only)

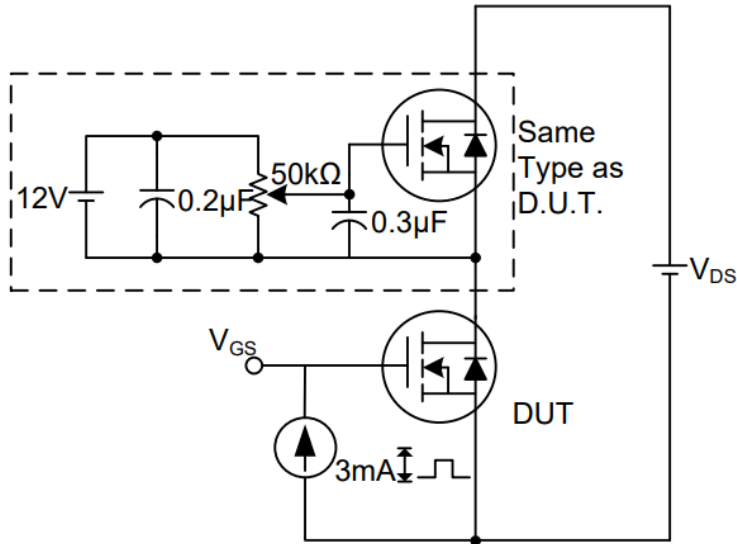

Gate Charge Test Circuit

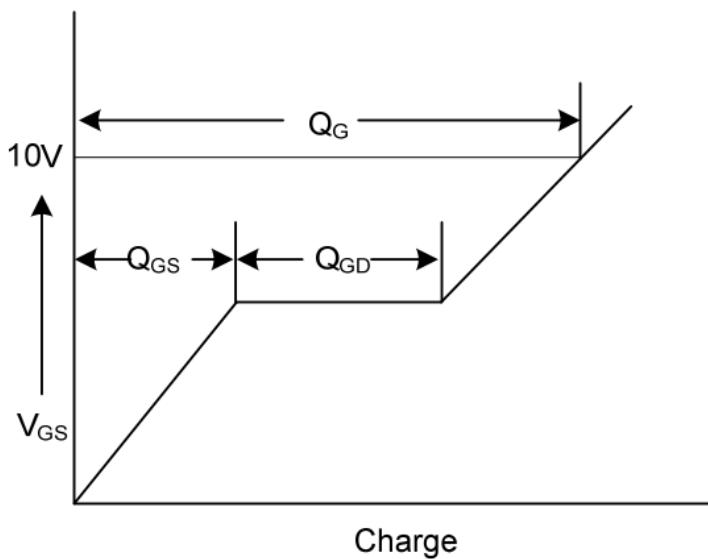

Gate Charge Waveform

SMD PLASTIC-ENCAPSULATE MOSFETS TO-220F SERIES

TEST CIRCUIT AND WAVEFORMS CURVE (For Reference Only)

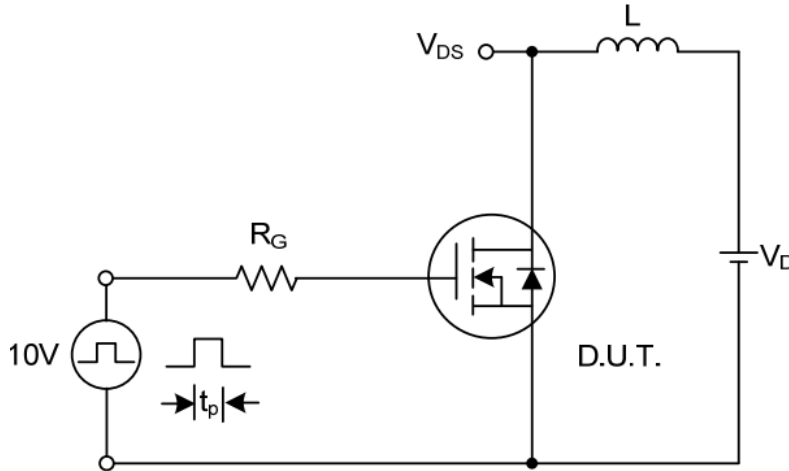

Unclamped Inductive Switching Test Circuit

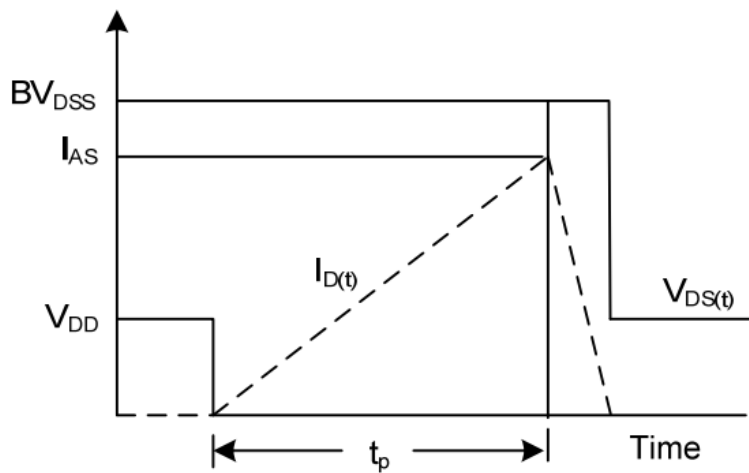

Unclamped Inductive Switching Waveforms

SMD PLASTIC-ENCAPSULATE MOSFETS TO-220F SERIES

PACKAGE For Reference

Case Code	TO- 220F
SPQ/Tube	50 pcs
Qty. /Box	1000 pcs
G.W/Box	6.0 LBS

DISCLAIMER

NextGen Component, Inc. reserves the right to make changes to the product(s) and or information contained herein without notice. No liability is assumed as a result of their use or application. No rights under any patent accompany the sale of any such product(s) or information

7/21/2023

17