



SPECIFICATION SHEET

SPECIFICATION SHEET NO.	Q0620- MT05B103K101DC
DATE	June 20, 2023
REVISION	A2
DESCRIPTION	Multilayer Ceramic Chip Capacitors MT0805 (2012 Metric) Series, L2.00*W1.25*H1.25mm, Thickness: 1.35mm Max. Dielectric X7R, Capacitance 0.01μF, Tolerance ±10%, Rated Voltage 100V Operating Temp. Range -55°C ~+125°C Package in Tape/Reel, 3,000pcs/Reel RoHS/RoHS III compliant
CUSTOMER	
CUSTOMER PART NUMBER	
CROSS REF. PART NUMBER	
ORIGINAL PART NUMBER	Aillen MT05B103K101DC
PART CODE	MT05B103K101DC

VENDOR APPROVE			
Issued/Checked/Approved			
DATE: June 20, 2023			

CUSTOMER APPROVE	
DATE:	
6/20/2023	

MULTILAYER CERAMIC CHIP CAPACITORS MT SERIES

MAIN FEATURE

MLCC consists of a conducting material and electrodes. To manufacture a chip-type SMT and achieve miniaturization, high density and high efficiency, ceramic condensers are used. MLCC is made by NP0, X7R, dielectric material and which provides product with high electrical precision, stability and reliability. Besides, MT series MLCC is tighten controlling in quality in line to assure quality performance in automotive applications.

MAIN FEATURE

- RoHS III Compliant • The MT series meet AEC-Q200 requirement. • High capacitance in given case size
- A wide selection of sizes is available (0201 to 1210) • Capacitor with lead-free termination (pure Tin)

APPLICATION

- For Navigation & Information equipments. • For entertainment equipments • For comfortable equipments
- For Automotive electronic equipment

RFQ
Request For Quotation

PART CODE GUIDE

Code	Name	Key Specification Option
MT	Product code	MT for Automotive safe concern (with AEC-Q200 qualification)
05	Size	0201 (0603): L0.60*W0.30mm; 0402 (1005): L1.00*W0.50mm 0603 (1608): L1.60*W0.80mm; 0805 (2012): L2.00*W1.25mm 1206 (3216): L3.20*W1.60mm; 1210 (3225): L3.20*W2.50mm
B	Dielectric	N: NP0 (COG); B: X7R;
103	Capacitance	Two significant digits followed by number of Zero, The 3rd digit signifies the multiplying factor, and letter R is decimal point. 0R5: 0.5pF; 3R3:3.3pF; 103: 0.01μF ; 100: 10pF
K	Tolerance	B=±0.1pF; C=±0.25pF; D=±0.5pF; F=±1%; G=±2%; J=±5%; K=±10% ; M=±20%;
101	Rated Voltage	Two significant digits followed by No. of zeros. "R" is in place of decimal point. 100=10 VDC; 160=16 VDC; 250=25 VDC; 500=50 VDC; 101 =100 VDC ; 201 =200 VDC; 251=250 VDC; 501 =500 VDC; 631 =630 VDC; 102 =1000 VDC;
D	Thickness	D: 1.25 ± 0.10mm, See Table 1
C	Package	A: 1Kpcs/Reel; B: 2Kpcs/Reel; C: 3Kpcs/Reel ; D: 4Kpcs/Reel; I: 10Kpcs/Reel; F: others
	Internal Control	Internal Code: Letter + Number; Blank: N/A;

MULTILAYER CERAMIC CHIP CAPACITORS MT SERIES

DIMENSION (Unit: mm)



Image for reference



Table 1

Size Code	L	W	T (Symbol)		Remark	M B
0201 (0603)	0.60±0.03	0.30±0.03	0.3±0.03	L	#	0.15±0.05
0402 (1005)	1.00±0.05	0.50±0.05	0.50±0.05	N	#	0.25±0.05/-0.10
0603 (1608)	1.60±0.10	0.80±0.10	0.80±0.07	S		0.40±0.15
	1.60+0.15/-0.10	0.80+0.15/-0.10	0.80+0.15/-0.10	X		
0805 (2012)	2.00±0.15	1.25±0.10	0.60±0.10	A		0.50±0.20
			0.80±0.10	B		
			1.25±0.10	D	#	
	2.00±0.20	1.25±0.20	1.25±0.20	I	#	
1206 (3216)	3.20±0.15	1.60±0.15	0.80±0.10	B		0.60±0.20
			0.95±0.10	C		
			1.25±0.10	D	#	
	3.20±0.20	1.60±0.15	1.15±0.15	J	#	
	3.20±0.20	1.60±0.20	1.60±0.20	G	#	
	3.20+0.3/-0.1	1.60+0.3/-0.1	1.60+0.30/-0.10	P	#	
1210 (3225)	3.20±0.30	2.50±0.20	0.95±0.10	C	#	0.75±0.25
			1.25±0.10	D	#	
	3.20±0.40	2.50±0.30	1.60±0.20	G	#	
			2.00±0.20	K	#	
			2.50±0.30	M	#	

Reflow soldering only is recommended.

6/20/2023

MULTILAYER CERAMIC CHIP CAPACITORS MT SERIES
GENERAL ELECTRONICAL CHARACTERISTICS
Table 2

Dielectric	NPO	X7R
Size	0201, 0402, 0603, 0805, 1206, 1210	0402, 0603, 0805, 1206
Capacitance range*	0.1pF to 0.047uF	100pF to 2.2uF
Capacitance Tolerance	5pF<Cap<10pF: B ($\pm 0.1\text{pF}$), C ($\pm 0.25\text{pF}$), D ($\pm 0.5\text{pF}$)	J ($\pm 5\%$), K ($\pm 10\%$), M ($\pm 20\%$)
Rated Voltage	10V, 16V, 25V, 50V, 100V, 200V, 250, 500, 630, 1000	
Operating Temperature	-55 ~+125°C	
Capacitance Characteristic	$\pm 30\text{ppm}$	$\pm 15\%$
Termination	Ni/Sn (lead-free termination)	

Note:

- 1) #1: NPO, 0.1pF product only provide B tolerance;
- 2) * Measured at the condition of 30~70% related humidity.
- 3) NPO: Apply $1.0 \pm 0.2\text{Vrms}$, $1.0\text{MHz} \pm 10\%$ for $\text{Cap} \leq 1000\text{pF}$ and $1.0 \pm 0.2\text{Vrms}$, $1.0\text{kHz} \pm 10\%$ for $\text{Cap} > 1000\text{pF}$, 25°C at ambient temperature.
- 4) X7R: Measured at $1.0 \pm 0.2\text{Vrms}$, $1.0\text{kHz} \pm 10\%$ for $C \leq 10\mu\text{F}$; $0.5 \pm 0.2\text{Vrms}$, $120\text{Hz} \pm 20\%$ for $C > 10\mu\text{F}$, 30~70% related humidity, 25° C ambient temperature for X7R.
- 5) ** Preconditioning for Class II MLCC: Perform a heat treatment at $150 \pm 10^\circ\text{C}$ for 1 hour and then leave in ambient condition for 24 ± 2 hours before measurement.

MULTILAYER CERAMIC CHIP CAPACITORS MT SERIES

CAPACITANCE RANGE - NP0 DIELECTRIC 0201, 0402 SIZES

Table 3-A

Size	0201					0402				
	VDC (V)	10	16	25	50	100	10	16	25	50
0.1pF (0R1)	L	L	L	L	L	N	N	N	N	N
0.2pF (0R2)	L	L	L	L	L	N	N	N	N	N
0.3pF (0R3)	L	L	L	L	L	N	N	N	N	N
0.4pF (0R4)	L	L	L	L	L	N	N	N	N	N
0.5pF (0R5)	L	L	L	L	L	N	N	N	N	N
0.6pF (0R6)	L	L	L	L	L	N	N	N	N	N
0.7pF (0R7)	L	L	L	L	L	N	N	N	N	N
0.8pF (0R8)	L	L	L	L	L	N	N	N	N	N
0.9pF (0R9)	L	L	L	L	L	N	N	N	N	N
1.0pF (1R0)	L	L	L	L	L	N	N	N	N	N
1.2pF (1R2)	L	L	L	L	L	N	N	N	N	N
1.5pF (1R5)	L	L	L	L	L	N	N	N	N	N
1.8pF (1R8)	L	L	L	L	L	N	N	N	N	N
2.0pF (2R0)	L	L	L	L	L	N	N	N	N	N
2.2pF (2R2)	L	L	L	L	L	N	N	N	N	N
2.7pF (2R7)	L	L	L	L	L	N	N	N	N	N
3.0pF (3R0)	L	L	L	L	L	N	N	N	N	N
3.3pF (3R3)	L	L	L	L	L	N	N	N	N	N
3.9pF (3R9)	L	L	L	L	L	N	N	N	N	N
4.0pF (4R0)	L	L	L	L	L	N	N	N	N	N
4.7pF (4R7)	L	L	L	L	L	N	N	N	N	N
5.0pF (5R0)	L	L	L	L	L	N	N	N	N	N
5.6pF (5R6)	L	L	L	L	L	N	N	N	N	N
6.0pF (6R0)	L	L	L	L	L	N	N	N	N	N
6.8pF (6R8)	L	L	L	L	L	N	N	N	N	N
7.0pF (7R0)	L	L	L	L	L	N	N	N	N	N
8.0pF (8R0)	L	L	L	L	L	N	N	N	N	N
8.2pF (8R2)	L	L	L	L	L	N	N	N	N	N
9.0pF (9R0)	L	L	L	L	L	N	N	N	N	N
10pF (100)	L	L	L	L	L	N	N	N	N	N
12pF (120)	L	L	L	L	L	N	N	N	N	N
15pF (150)	L	L	L	L	L	N	N	N	N	N
18pF (180)	L	L	L	L	L	N	N	N	N	N
22pF (220)	L	L	L	L	L	N	N	N	N	N
27pF (270)	L	L	L	L	L	N	N	N	N	N

MULTILAYER CERAMIC CHIP CAPACITORS MT SERIES

CAPACITANCE RANGE - NPO DIELECTRIC 0201, 0402 SIZES

Table 3-B

Size	0201					0402				
VDC (V)	10	16	25	50	100	10	16	25	50	100
33pF (330)	L	L	L	L	L	N	N	N	N	N
39pF (390)	L	L	L	L	L	N	N	N	N	N
47pF (470)	L	L	L	L	L	N	N	N	N	N
56pF (560)	L	L	L	L	L	N	N	N	N	N
68pF (680)	L	L	L	L	L	N	N	N	N	N
82pF (820)	L	L	L	L	L	N	N	N	N	N
100pF (101)	L	L	L	L	L	N	N	N	N	N
120pF (121)	L	L	L	L	L	N	N	N	N	N
150pF (151)						N	N	N	N	N
180pF (181)						N	N	N	N	N
220pF (221)						N	N	N	N	N
270pF (271)						N	N	N	N	
330pF (331)						N	N	N	N	
390pF (391)						N	N	N	N	
470pF (471)						N	N	N	N	
560pF (561)						N	N	N	N	
680pF (681)						N	N	N	N	
820pF (821)						N	N	N	N	
1,000pF (102)						N	N	N	N	

CAPACITANCE RANGE - NPO DIELECTRIC 0603 SIZES

Table 3-C

Size	0603						
VDC (V)	10	16	25	50	100	200	250
0.5pF (0R5)	S	S	S	S	S	S	S
0.6pF (0R6)	S	S	S	S	S	S	S
0.7pF (0R7)	S	S	S	S	S	S	S
0.8pF (0R8)	S	S	S	S	S	S	S
0.9pF (0R9)	S	S	S	S	S	S	S
1.0pF (1R0)	S	S	S	S	S	S	S
1.2pF (1R2)	S	S	S	S	S	S	S
1.5pF (1R5)	S	S	S	S	S	S	S
1.8pF (1R8)	S	S	S	S	S	S	S
2.0pF (2R0)	S	S	S	S	S	S	S

MULTILAYER CERAMIC CHIP CAPACITORS MT SERIES

CAPACITANCE RANGE - NP0 DIELECTRIC 0603 SIZES

Table 3-D

Size	0603						
VDC (V)	10	16	25	50	100	200	250
2.2pF (2R2)	S	S	S	S	S	S	S
2.7pF (2R7)	S	S	S	S	S	S	S
3.0pF (3R0)	S	S	S	S	S	S	S
3.3pF (3R3)	S	S	S	S	S	S	S
3.9pF (3R9)	S	S	S	S	S	S	S
4.0pF (4R0)	S	S	S	S	S	S	S
4.7pF (4R7)	S	S	S	S	S	S	S
5.0pF (5R0)	S	S	S	S	S	S	S
5.6pF (5R6)	S	S	S	S	S	S	S
6.0pF (6R0)	S	S	S	S	S	S	S
6.8pF (6R8)	S	S	S	S	S	S	S
7.0pF (7R0)	S	S	S	S	S	S	S
8.0pF (8R0)	S	S	S	S	S	S	S
8.2pF (8R2)	S	S	S	S	S	S	S
9.0pF (9R0)	S	S	S	S	S	S	S
10pF (100)	S	S	S	S	S	S	S
12pF (120)	S	S	S	S	S	S	S
15pF (150)	S	S	S	S	S	S	S
18pF (180)	S	S	S	S	S	S	S
22pF (220)	S	S	S	S	S	S	S
27pF (270)	S	S	S	S	S	S	S
33pF (330)	S	S	S	S	S	S	S
39pF (390)	S	S	S	S	S	S	S
47pF (470)	S	S	S	S	S	S	S
56pF (560)	S	S	S	S	S	S	S
68pF (680)	S	S	S	S	S	S	S
82pF (820)	S	S	S	S	S	S	S
100pF (101)	S	S	S	S	S	S	S
120pF (121)	S	S	S	S	S	S	S
150pF (151)	S	S	S	S	S	S	S
180pF (181)	S	S	S	S	S	S	S
220pF (221)	S	S	S	S	S	S	S
270pF (271)	S	S	S	S	S	X	X
330pF (331)	S	S	S	S	S	X	X
390pF (391)	S	S	S	S	S	X	X

MULTILAYER CERAMIC CHIP CAPACITORS MT SERIES

CAPACITANCE RANGE - NPO DIELECTRIC 0603 SIZES

Table 3-E

Size	0603						
VDC (V)	10	16	25	50	100	200	250
470pF (471)	S	S	S	S	S	X	X
560pF (561)	S	S	S	S	S		
680pF (681)	S	S	S	S	S		
820pF (821)	S	S	S	S	S		
1,000pF (102)	S	S	S	S	S		
1,200pF (122)	X	X	X	X			
1,500pF (152)	X	X	X	X			
1,800pF (182)	X	X	X	X			
2,200pF (222)	X	X	X	X			
2,700pF (272)	X	X	X	X			
3,300pF (332)	X	X	X	X			

CAPACITANCE RANGE - NPO DIELECTRIC 0805 SIZES

Table 3-F

Size	0805								
VDC (V)	10	16	25	50	100	200	250	500	630
0.5pF (0R5)	A	A	A	A	A	A	A	A	A
0.6pF (0R6)	A	A	A	A	A	A	A	A	A
0.7pF (0R7)	A	A	A	A	A	A	A	A	A
0.8pF (0R8)	A	A	A	A	A	A	A	A	A
0.9pF (0R9)	A	A	A	A	A	A	A	A	A
1.0pF (1R0)	A	A	A	A	A	A	A	A	A
1.2pF (1R2)	A	A	A	A	A	A	A	A	A
1.5pF (1R5)	A	A	A	A	A	A	A	A	A
1.8pF (1R8)	A	A	A	A	A	A	A	A	A
2.2pF (2R2)	A	A	A	A	A	A	A	A	A
2.7pF (2R7)	A	A	A	A	A	A	A	A	A
3.3pF (3R3)	A	A	A	A	A	A	A	A	A
3.9pF (3R9)	A	A	A	A	A	A	A	A	A
4.7pF (4R7)	A	A	A	A	A	A	A	A	A
5.6pF (5R6)	A	A	A	A	A	A	A	A	A
6.8pF (6R8)	A	A	A	A	A	A	A	A	A
8.2pF (8R2)	A	A	A	A	A	A	A	A	A

MULTILAYER CERAMIC CHIP CAPACITORS MT SERIES

CAPACITANCE RANGE - NPO DIELECTRIC 0805 SIZES

Table 3-G

Size	0805								
VDC (V)	10	16	25	50	100	200	250	500	630
10pF (100)	A	A	A	A	A	A	A	A	A
12pF (120)	A	A	A	A	A	A	A	A	A
15pF (150)	A	A	A	A	A	A	A	A	A
18pF (180)	A	A	A	A	A	A	A	A	A
22pF (220)	A	A	A	A	A	A	A	A	A
27pF (270)	A	A	A	A	A	A	A	A	A
33pF (330)	A	A	A	A	A	A	A	A	A
39pF (390)	A	A	A	A	A	A	A	A	A
47pF (470)	A	A	A	A	A	A	A	A	A
56pF (560)	A	A	A	A	A	A	A	A	A
68pF (680)	A	A	A	A	A	A	A	A	A
82pF (820)	A	A	A	A	A	A	A	B	B
100pF (101)	A	A	A	A	A	B	B	B	B
120pF (121)	A	A	A	A	A	B	B	D	D
150pF (151)	A	A	A	A	A	D	D	D	D
180pF (181)	A	A	A	A	A	D	D	D	D
220pF (221)	A	A	A	A	A	D	D	D	D
270pF (271)	A	A	A	A	A	D	D	D	D
330pF (331)	A	A	A	A	A	D	D	D	D
390pF (391)	B	B	A	A	A	D	D	D	D
470pF (471)	B	B	B	B	B	D	D	I	I
560pF (561)	B	B	B	B	B	D	D	I	I
680pF (681)	B	B	B	B	B	D	D	I	I
820pF (821)	B	B	B	B	B	D	D	I	I
1,000pF (102)	B	B	B	B	B	D	D	I	I
1,200pF (122)	B	B	B	B	B	D	D		
1,500pF (152)	B	B	B	B	B	D	D		
1,800pF (182)	B	B	B	B	B	D	D		
2,200pF (222)	B	B	B	B	B	D	D		
2,700pF (272)	D	D	D	D	D				
3,300pF (332)	D	D	D	D	D				
3,900pF (392)	D	D	D	D	D				
4,700pF (472)	D	D	D	D	D				
5,600pF (562)	D	D	D	D	D				
6,800pF (682)	D	D	D	D	D				
8,200pF (822)	D	D	D	D					
0.01μF (103)	D	D	D	D					

MULTILAYER CERAMIC CHIP CAPACITORS MT SERIES

CAPACITANCE RANGE - NPO DIELECTRIC 1206

Table 3-H

Size	1206									
VDC (V)	10	16	25	50	100	200	250	500	630	1000
1.2pF (1R2)	B	B	B	B	B	B	B	B	B	
1.5pF (1R5)	B	B	B	B	B	B	B	B	B	B
1.8pF (1R8)	B	B	B	B	B	B	B	B	B	B
2.2pF (2R2)	B	B	B	B	B	B	B	B	B	B
2.7pF (2R7)	B	B	B	B	B	B	B	B	B	B
3.3pF (3R3)	B	B	B	B	B	B	B	B	B	B
3.9pF (3R9)	B	B	B	B	B	B	B	B	B	B
4.7pF (4R7)	B	B	B	B	B	B	B	B	B	B
5.6pF (5R6)	B	B	B	B	B	B	B	B	B	B
6.8pF (6R8)	B	B	B	B	B	B	B	B	B	B
8.2pF (8R2)	B	B	B	B	B	B	B	B	B	B
10pF (100)	B	B	B	B	B	B	B	B	B	B
12pF (120)	B	B	B	B	B	B	B	B	B	B
15pF (150)	B	B	B	B	B	B	B	B	B	B
18pF (180)	B	B	B	B	B	B	B	B	B	B
22pF (220)	B	B	B	B	B	B	B	B	B	D
27pF (270)	B	B	B	B	B	B	B	B	B	D
33pF (330)	B	B	B	B	B	B	B	B	B	D
39pF (390)	B	B	B	B	B	B	B	B	B	D
47pF (470)	B	B	B	B	B	B	B	B	B	D
56pF (560)	B	B	B	B	B	B	B	B	B	D
68pF (680)	B	B	B	B	B	B	B	B	B	D
82pF (820)	B	B	B	B	B	B	B	B	B	D
100pF (101)	B	B	B	B	B	B	B	B	B	D
120pF (121)	B	B	B	B	B	B	B	B	B	D
150pF (151)	B	B	B	B	B	B	B	B	B	D
180pF (181)	B	B	B	B	B	B	B	B	B	G
220pF (221)	B	B	B	B	B	B	B	B	B	G
270pF (271)	B	B	B	B	B	B	C	C	C	G
330pF (331)	B	B	B	B	B	B	C	C	C	G
390pF (391)	B	B	B	B	B	B	C	C	C	G
470pF (471)	B	B	B	B	B	C	C	C	C	G
560pF (561)	B	B	B	B	B	C	D	D	D	G
680pF (681)	B	B	B	B	B	C	D	D	D	G
820pF (821)	B	B	B	B	B	C	G	G	G	G

MULTILAYER CERAMIC CHIP CAPACITORS MT SERIES

CAPACITANCE RANGE - NPO DIELECTRIC 1206 SIZES

Table 3-I

Size	1206									
VDC (V)	10	16	25	50	100	200	250	500	630	1000
1,000pF (102)	B	B	B	B	B	C	G	G	G	G
1,200pF (122)	B	B	B	B	B	C	G	G	G	
1,500pF (152)	B	B	B	B	B	D	G	G	G	
1,800pF (182)	B	B	B	B	B	D	G	G	G	
2,200pF (222)	B	B	B	B	B	D	G	G	G	
2,700pF (272)	B	B	B	B	B	D	G	G	G	
3,300pF (332)	B	B	B	B	B	D	G	G	G	
3,900pF (392)	B	B	B	B	B	D	G	G	G	
4,700pF (472)	B	B	B	B	B	D	G	G	G	
5,600pF (562)	B	B	B	B	B					
6,800pF (682)	C	C	C	C	C					
8,200pF (822)	D	D	D	D	D					
0.01μF (103)	D	D	D	D	D					

CAPACITANCE RANGE - NPO DIELECTRIC 1210 SIZES

Table 3-J

Size	1210									
VDC (V)	10	16	25	50	100	200	250	500	630	1000
10pF (100)	C	C	C	C	C	C	C	C	C	C
12pF (120)	C	C	C	C	C	C	C	C	C	C
15pF (150)	C	C	C	C	C	C	C	C	C	C
18pF (180)	C	C	C	C	C	C	C	C	C	C
22pF (220)	C	C	C	C	C	C	C	C	C	C
27pF (270)	C	C	C	C	C	C	C	C	C	C
33pF (330)	C	C	C	C	C	C	C	C	C	C
39pF (390)	C	C	C	C	C	C	C	C	C	C
47pF (470)	C	C	C	C	C	C	C	C	C	C
56pF (560)	C	C	C	C	C	C	C	C	C	C
68pF (680)	C	C	C	C	C	C	C	C	C	C
82pF (820)	C	C	C	C	C	C	C	C	C	C
100pF (101)	C	C	C	C	C	C	C	C	C	D
120pF (121)	C	C	C	C	C	C	C	C	C	D
150pF (151)	C	C	C	C	C	C	C	C	C	D
180pF (181)	C	C	C	C	C	C	C	C	C	D
220pF (221)	C	C	C	C	C	C	C	C	C	G

MULTILAYER CERAMIC CHIP CAPACITORS MT SERIES

CAPACITANCE RANGE - NPO DIELECTRIC 1210 SIZES

Table 3-K

Size	1210									
	10	16	25	50	100	200	250	500	630	1000
VDC (V)										
270pF (271)	C	C	C	C	C	C	C	C	C	G
330pF (331)	C	C	C	C	C	C	C	C	C	G
390pF (391)	C	C	C	C	C	C	C	C	C	G
470pF (471)	C	C	C	C	C	C	C	C	C	G
560pF (561)	C	C	C	C	C	C	C	C	C	G
680pF (681)	C	C	C	C	C	C	C	C	C	G
820pF (821)	C	C	C	C	C	C	C	C	C	G
1,000pF (102)	C	C	C	C	C	D	D	D	D	G
1,200pF (122)	C	C	C	C	C	D	D	D	D	
1,500pF (152)	C	C	C	C	C	D	D	D	D	
1,800pF (182)	C	C	C	C	C	D	D	D	D	
2,200pF (222)	C	C	C	C	C	D	D	D	D	
2,700pF (272)	C	C	C	C	C	D	D	D	D	
3,300pF (332)	C	C	C	C	C	D	D	D	D	
3,900pF (392)	C	C	C	C	C	D	D	D	D	
4,700pF (472)	C	C	C	C	C	G	G			
5,600pF (562)	C	C	C	C	C	G	G			
6,800pF (682)	C	C	C	C	C	G	G			
8,200pF (822)	C	C	C	C	C	G	G			
0.010μF (103)	C	C	C	C	C	G	G			
0.012μF (123)	D	D	D	D	D					
0.015μF (153)	D	D	D	D	D					
0.018μF (183)	K	K	K	K	K					
0.022μF (223)	K	K	K	K	K					
0.027μF (273)	K	K	K	K	K					
0.033μF (333)	K	K	K	K	K					
0.039μF (393)	K	K	K	K	K					
0.047μF (473)	K	K	K	K	K					

MULTILAYER CERAMIC CHIP CAPACITORS MT SERIES

CAPACITANCE RANGE – X7R DIELECTRIC 0201, 0402 SIZES

Table 4-A

Size	0201				0402			
	10	16	25	50	10	16	25	50
VDC (V)								
100pF (101)	L	L	L	L	N	N	N	N
120pF (121)	L	L	L	L	N	N	N	N
150pF (151)	L	L	L	L	N	N	N	N
180pF (181)	L	L	L	L	N	N	N	N
220pF (221)	L	L	L	L	N	N	N	N
270pF (271)	L	L	L	L	N	N	N	N
330pF (331)	L	L	L	L	N	N	N	N
390pF (391)	L	L	L	L	N	N	N	N
470pF (471)	L	L	L	L	N	N	N	N
560pF (561)	L	L	L	L	N	N	N	N
680pF (681)	L	L	L	L	N	N	N	N
820pF (821)	L	L	L	L	N	N	N	N
1,000pF (102)	L	L	L	L	N	N	N	N
1,200pF (122)	L	L	L		N	N	N	N
1,500pF (152)	L	L	L		N	N	N	N
1,800pF (182)	L	L	L		N	N	N	N
2,200pF (222)	L	L	L		N	N	N	N
2,700pF (272)	L	L	L		N	N	N	N
3,300pF (332)	L	L	L		N	N	N	N
3,900pF (392)	L	L	L		N	N	N	N
4,700pF (472)	L	L	L		N	N	N	N
5,600pF (562)	L	L	L		N	N	N	N
6,800pF (682)	L				N	N	N	N
8,200pF (822)	L				N	N	N	N
0.010μF (103)	L				N	N	N	N
0.012μF (123)					N	N	N	
0.015μF (153)					N	N	N	
0.018μF (183)					N	N	N	
0.022μF (223)					N	N	N	
0.027μF (273)					N	N	N	
0.033μF (333)					N	N	N	
0.039μF (393)					N	N	N	
0.047μF (473)					N	N	N	
0.056μF (563)					N	N	N	
0.068μF (683)					N	N	N	
0.082μF (823)					N	N	N	
0.10μF (104)					N	N	N	

MULTILAYER CERAMIC CHIP CAPACITORS MT SERIES

CAPACITANCE RANGE – X7R DIELECTRIC 0603 SIZES

Table 4-B

Size	0603				
	10	16	25	50	100
VDC (V)					
100pF (101)	S	S	S	S	S
120pF (121)	S	S	S	S	S
150pF (151)	S	S	S	S	S
180pF (181)	S	S	S	S	S
220pF (221)	S	S	S	S	S
270pF (271)	S	S	S	S	S
330pF (331)	S	S	S	S	S
390pF (391)	S	S	S	S	S
470pF (471)	S	S	S	S	S
560pF (561)	S	S	S	S	S
680pF (681)	S	S	S	S	S
820pF (821)	S	S	S	S	S
1,000pF (102)	S	S	S	S	S
1,200pF (122)	S	S	S	S	S
1,500pF (152)	S	S	S	S	S
1,800pF (182)	S	S	S	S	S
2,200pF (222)	S	S	S	S	S
2,700pF (272)	S	S	S	S	S
3,300pF (332)	S	S	S	S	S
3,900pF (392)	S	S	S	S	S
4,700pF (472)	S	S	S	S	S
5,600pF (562)	S	S	S	S	S
6,800pF (682)	S	S	S	S	S
8,200pF (822)	S	S	S	S	S
0.010μF (103)	S	S	S	S	S
0.012μF (123)	S	S	S	S	X
0.015μF (153)	S	S	S	S	X
0.018μF (183)	S	S	S	S	X
0.022μF (223)	S	S	S	S	X
0.027μF (273)	S	S	S	S	X
0.033μF (333)	S	S	S	X	X
0.039μF (393)	S	S	S	X	X
0.047μF (473)	S	S	S	X	X
0.056μF (563)	S	S	S	X	
0.068μF (683)	S	S	S	X	

MULTILAYER CERAMIC CHIP CAPACITORS MT SERIES

CAPACITANCE RANGE – X7R DIELECTRIC 0603 SIZES

Table 4-C

Size	0603				
VDC (V)	10	16	25	50	100
0.082µF (823)	S	S	S	X	
0.10µF (104)	S	S	S	X	
0.12µF (124)	X	X	X		
0.15µF (154)	X	X	X	X	
0.18µF (184)	X	X	X		
0.22µF (224)	X	X	X	X	
0.33µF (334)	X	X	X	X	

CAPACITANCE RANGE – X7R DIELECTRIC 0805 SIZES

Table 4-D

Size	0805								
VDC (V)	10	16	25	50	100	200	250	500	630
100pF (101)	B	B	B	B	B	B	B	B	B
120pF (121)	B	B	B	B	B	B	B	B	B
150pF (151)	B	B	B	B	B	B	B	B	B
180pF (181)	B	B	B	B	B	B	B	B	B
220pF (221)	B	B	B	B	B	B	B	B	B
270pF (271)	B	B	B	B	B	B	B	B	B
330pF (331)	B	B	B	B	B	B	B	B	B
390pF (391)	B	B	B	B	B	B	B	B	B
470pF (471)	B	B	B	B	B	B	B	B	B
560pF (561)	B	B	B	B	B	B	B	B	B
680pF (681)	B	B	B	B	B	B	B	B	B
820pF (821)	B	B	B	B	B	B	B	B	B
1,000pF (102)	B	B	B	B	B	B	B	B	B
1,200pF (122)	B	B	B	B	B	B	B	B	B
1,500pF (152)	B	B	B	B	B	B	B	B	B
1,800pF (182)	B	B	B	B	B	B	B	B	B
2,200pF (222)	B	B	B	B	B	B	B	B	B
2,700pF (272)	B	B	B	B	B	B	B	B	B
3,300pF (332)	B	B	B	B	B	B	B	B	B
3,900pF (392)	B	B	B	B	B	B	B	B	B
4,700pF (472)	B	B	B	B	B	B	B	D	D

MULTILAYER CERAMIC CHIP CAPACITORS MT SERIES
CAPACITANCE RANGE – X7R DIELECTRIC 0805 SIZES
Table 4-E

Size	0805								
VDC (V)	10	16	25	50	100	200	250	500	630
5,600pF (562)	B	B	B	B	B	B	B	D	D
6,800pF (682)	B	B	B	B	B	B	B	D	D
8,200pF (822)	B	B	B	B	B	B	B	D	D
0.010μF (103)	B	B	B	B	B	D	D	D	D
0.012μF (123)	B	B	B	B	B	D	D		
0.015μF (153)	B	B	B	B	B	D	D		
0.018μF (183)	B	B	B	B	B	D	D		
0.022μF (223)	B	B	B	B	B	D	D		
0.027μF (273)	B	B	B	B	B				
0.033μF (333)	B	B	B	B	B				
0.039μF (393)	B	B	B	B	B				
0.047μF (473)	B	B	B	B	B				
0.056μF (563)	B	B	B	B	B				
0.068μF (683)	B	B	B	B	D				
0.082μF (823)	B	B	B	B	D				
0.10μF (104)	B	B	B	B	D				
0.12μF (124)	B	B	B	D					
0.15μF (154)	D	D	D	D					
0.18μF (184)	D	D	D	D					
0.22μF (224)	D	D	D	D					
0.27μF (274)	D	D	D	I					
0.33μF (334)	D	D	D	I					
0.39μF (394)	D	D	D	I					
0.47μF (474)	D	D	D	I					
0.56μF (564)	D	D	D						
0.68μF (684)	D	D	D	I					
0.82μF (824)	D	D	D						
1.0μF (105)	D	D	D	I					

CAPACITANCE RANGE – X7R DIELECTRIC 1206 SIZES
Table 4-F

Size	1206								
VDC (V)	10	16	25	50	100	200	250	500	630
100pF (101)						D	D	D	D
120pF (121)						D	D	D	D
150pF (151)	B	B	B	B	B	D	D	D	D
180pF (181)	B	B	B	B	B	D	D	D	D

MULTILAYER CERAMIC CHIP CAPACITORS MT SERIES

CAPACITANCE RANGE – X7R DIELECTRIC 1206 SIZES

Table 4-G

Size	1206								
VDC (V)	10	16	25	50	100	200	250	500	630
220pF (221)	B	B	B	B	B	D	D	D	D
270pF (271)	B	B	B	B	B	D	D	D	D
330pF (331)	B	B	B	B	B	D	D	D	D
390pF (391)	B	B	B	B	B	D	D	D	D
470pF (471)	B	B	B	B	B	D	D	D	D
560pF (561)	B	B	B	B	B	D	D	D	D
680pF (681)	B	B	B	B	B	D	D	D	D
820pF (821)	B	B	B	B	B	D	D	D	D
1,000pF (102)	B	B	B	B	B	D	D	D	D
1,200pF (122)	B	B	B	B	B	D	D	D	D
1,500pF (152)	B	B	B	B	B	D	D	D	D
1,800pF (182)	B	B	B	B	B	D	D	D	D
2,200pF (222)	B	B	B	B	B	D	D	D	D
2,700pF (272)	B	B	B	B	B	D	D	D	D
3,300pF (332)	B	B	B	B	B	D	D	D	D
3,900pF (392)	B	B	B	B	B	D	D	D	D
4,700pF (472)	B	B	B	B	B	D	D	D	D
5,600pF (562)	B	B	B	B	B	D	D	D	D
6,800pF (682)	B	B	B	B	B	D	D	D	D
8,200pF (822)	B	B	B	B	B	D	D	D	D
0.010μF (103)	B	B	B	B	B	D	D	D	D
0.012μF (123)	B	B	B	B	B	D	D		
0.015μF (153)	B	B	B	B	B	D	D		
0.018μF (183)	B	B	B	B	B	D	D		
0.022μF (223)	B	B	B	B	B	D	D		
0.027μF (273)	B	B	B	B	B				
0.033μF (333)	B	B	B	B	B				
0.039μF (393)	B	B	B	B	B				
0.047μF (473)	B	B	B	B	B				
0.056μF (563)	B	B	B	B	B				
0.068μF (683)	B	B	B	B	B				
0.082μF (823)	B	B	B	B	D				
0.10μF (104)	B	B	B	B	D				
0.12μF (124)	B	B	B	B	D				
0.15μF (154)	C	C	C	C	G				
0.18μF (184)	C	C	C	C	G				

MULTILAYER CERAMIC CHIP CAPACITORS MT SERIES

CAPACITANCE RANGE – X7R DIELECTRIC 1206 SIZES

Table 4-H

Size	1206								
VDC (V)	10	16	25	50	100	200	250	500	630
0.22µF (224)	C	C	C	C	G				
0.27µF (274)	C	C	C	D					
0.33µF (334)	C	C	C	D					
0.39µF (394)	C	C	J	P					
0.47µF (474)	J	J	J	P					
0.56µF (564)	J	J	J	P					
0.68µF (684)	J	J	J	P					
0.82µF (824)	J	J	J	P					
1.0µF (105)	J	J	J	P					

CAPACITANCE RANGE – X7R DIELECTRIC 1210 SIZES

Table 4-I

Size	1210								
VDC (V)	10	16	25	50	100	250	500	1000	
100pF (101)						D	D	D	
120pF (121)						D	D	D	
150pF (151)						D	D	D	
180pF (181)						D	D	D	
220pF (221)						D	D	D	
270pF (271)						D	D	D	
330pF (331)						D	D	D	
390pF (391)						D	D	D	
470pF (471)						D	D	D	
560pF (561)						D	D	D	
680pF (681)						C	D	D	
820pF (821)						C	D	D	
1,000pF (102)	C	C	C	C	C	C	D	D	
1,200pF (122)	C	C	C	C	C	C	D	D	
1,500pF (152)	C	C	C	C	C	C	D	D	
1,800pF (182)	C	C	C	C	C	C	D	D	
2,200pF (222)	C	C	C	C	C	C	D	D	
2,700pF (272)	C	C	C	C	C	C	D	D	
3,300pF (332)	C	C	C	C	C	C	D	D	
3,900pF (392)	C	C	C	C	C	C	D	G	
4,700pF (472)	C	C	C	C	C	C	D	G	
5,600pF (562)	C	C	C	C	C	C	D	G	

MULTILAYER CERAMIC CHIP CAPACITORS MT SERIES

CAPACITANCE RANGE – X7R DIELECTRIC 1210 SIZES

Table 4-J

Size	1210							
	10	16	25	50	100	250	500	1000
VDC (V)								
6,800pF (682)	C	C	C	C	C	C	D	G
8,200pF (822)	C	C	C	C	C	C	D	G
0.010μF (103)	C	C	C	C	C	C	D	G
0.012μF (123)	C	C	C	C	C	C	D	
0.015μF (153)	C	C	C	C	C	C	D	
0.018μF (183)	C	C	C	C	C	C	D	
0.022μF (223)	C	C	C	C	C	C	D	
0.027μF (273)	C	C	C	C	C	C		
0.033μF (333)	C	C	C	C	C	C		
0.039μF (393)	C	C	C	C	C	C		
0.047μF (473)	C	C	C	C	C	D		
0.056μF (563)	C	C	C	C	C			
0.068μF (683)	C	C	C	C	C			
0.082μF (823)	C	C	C	C	C			
0.10μF (104)	C	C	C	C	C			
0.12μF (124)	C	C	C	C				
0.15μF (154)	C	C	C	C				
0.18μF (184)	C	C	C	C				
0.22μF (224)	C	C	C	C				
0.27μF (274)	C	C	C	C				
0.33μF (334)	C	C	C	D				
0.39μF (394)	C	C	C	D				
0.47μF (474)	C	C	C	D				
0.56μF (564)	D	D	D	D				
0.68μF (684)	D	D	D	D				
0.82μF (824)	D	D	D	D				
1.0μF (105)	D	D	D	D				
1.5μF (155)		K						
2.2μF (225)		K						

MULTILAYER CERAMIC CHIP CAPACITORS MT SERIES

High Temperature Exposure – Requirements–X7R

Table 5

Rated vol.	DF ≤	Exception of DF ≤	
≥50V	≤ 3%	≤ 6%	0201(50V); 0603≥0.047μF; 0805≥0.18μF; 1206≥0.47μF;
		≤ 10%	1210≥4.7μF;
		≤ 20%	0402≥0.1μF; 0603≥1μF; 0805≥1μF; 1206≥2.2μF;
35V	≤ 5%	≤20%	0603≥1μF; 0805≥2.2μF; 1210≥10μF;
25V	≤ 5%	≤10%	0201≥0.01μF; 0805≥1μF; 1210≥10μF
		≤15%	0603≥0.33μF; 1206≥4.7μF; 0402≥0.10μF; 0603≥0.47μF; 0805≥2.2μF; 1206≥6.8μF; 1210≥22μF;
16V	≤5%	≤10%	0603≥0.15μF;0805≥0.68μF;1206≥2.2μF;1210≥4.7μF
		≤15%	0201≥0.01μF;0402≥0.033μF; 0603≥0.68μF;0805≥2.2μF 1206≥4.7μF; 1210≥22μF;
10V	≤ 7.5%	≤15%	0201≥0.012μF;0402≥0.33μF; 0603≥0.33μF;0805≥2.2μF 1206≥2.2μF; 1210≥22μF
		≤20%	0201≥0.1μF ;0402≥1μF;
6.3V	≤ 15%	≤30%	0201≥0.1μF;0402≥1μF; 0603≥10μF;0805≥4.7μF; 1206≥47μF;1210≥100μF;
4V	≤20%	---	---

IR.: ≥10GΩ or RxC≥500Ω-F whichever is smaller

High Temperature Exposure – Requirements –Class II-X7R

Table 6

Rated voltage	Insulation Resistance
≥100V: X7R	1GΩ or RxC≥10Ω-F whichever is smaller
50V:0603≥1μF;0805≥1μF; 1206≥4.7μF;1210≥4.7μF	
35V:0805≥2.2μF;1210≥10μF	
25V:0402≥1μF;0603≥2.2μF;0805≥2.2μF; 1206≥10μF;1210≥10μF	
16V: 0201≥0.1μF;0402≥0.22μF; 0603≥1μF;0805≥2.2μF; 1206≥10μF;1210≥47μF	
10V:0201≥47nF;0402≥0.47μF; 0603≥0.47μF;0805≥2.2μF; 1206≥4.7μF;1210≥47μF	

MULTILAYER CERAMIC CHIP CAPACITORS MT SERIES
Temperature Cycling-Requirements –X7R
Table 7

Rated vol.	DF ≤	Exception of DF ≤	
≥50V	≤ 3%	≤ 6%	0201(50V); 0603≥0.047μF; 0805≥0.18μF; 1206≥0.47μF;
		≤ 10%	1210≥4.7μF;
		≤ 20%	0402≥0.1μF;0603≥1μF; 0805≥1μF;1206≥2.2μF; 1210≥10μF;
35V	≤ 5%	≤20%	0603≥1μF; 0805≥2.2μF; 1210≥10μF;
25V	≤ 5%	≤10%	0201≥0.01μF; 0805≥1μF; 1210≥10μF
		≤14%	0603≥0.33μF;1206≥4.7μF
		≤15%	0402≥0.10μF;0603≥0.47μF;0805≥2.2μF;1206≥6.8μF; 1210≥22μF;
16V	≤5%	≤10%	0603≥0.15μF;0805≥0.68μF;1206≥2.2μF;1210≥4.7μF
		≤15%	0201≥0.01μF;0402≥0.033μF; 0603≥0.68μF;0805≥2.2μF 1206≥4.7μF; 1210≥22μF;
10V	≤ 7.5%	≤15%	0201≥0.012μF;0402≥0.33μF; 0603≥0.33μF;0805≥2.2μF 1206≥2.2μF; 1210≥22μF
		≤20%	0201≥0.1μF ;0402≥1μF;
6.3V	≤ 15%	≤30%	0201≥0.1μF;0402≥1μF;0603 ≥10μF; 0805≥4.7μF;1206≥47μF;1210≥100μF;
4V	≤20%	---	---

IR.: ≥10GΩ or RxC≥500Ω-F whichever is smaller

Temperature Cycling– Requirements –Class II-X7R
Table 8

Rated voltage	Insulation Resistance
≥100V: X7R	1GΩ or RxC≥10Ω-F whichever is smaller
50V:0603≥1μF;0805≥1μF; 1206≥4.7μF;1210≥4.7μF	
35V:0805≥2.2μF;1210≥10μF	
25V:0402≥1μF;0603≥2.2μF;0805≥2.2μF; 1206≥10μF;1210≥10μF	
16V: 0201≥0.1uF;0402≥0.22μF; 0603≥1μF;0805≥2.2μF; 1206≥10μF;1210≥47μF	
10V:0201≥47nF;0402≥0.47μF; 0603≥0.47μF;0805≥2.2μF; 1206≥4.7μF;1210≥47μF	
6.3V; 4V;	

MULTILAYER CERAMIC CHIP CAPACITORS MT SERIES

Moisture Resistance – Requirements –X7R

Table 9

Rated vol.	DF ≤	Exception of DF ≤	
≥50V	≤ 3%	≤ 6%	0201(50V); 0603≥0.047μF; 0805≥0.18μF; 1206≥0.47μF;
		≤ 10%	1210≥4.7μF;
		≤ 20%	0402≥0.1μF;0603≥1μF; 0805≥1μF;1206≥2.2μF; 1210≥10μF; TT series
35V	≤ 5%	≤20%	0603≥1μF; 0805≥2.2μF; 1210≥10μF;
25V	≤ 5%	≤10%	0201≥0.01μF; 0805≥1μF; 1210≥10μF
		≤14%	0603≥0.33μF;1206≥4.7μF
		≤15%	0402≥0.10μF;0603≥0.47μF;0 805≥2.2μF;1206≥6.8μF; 1210≥22μF; TT series
16V	≤5%	≤10%	0603≥0.15μF;0805≥0.68μF;1206≥2.2μF;1210≥4.7μF
		≤15%	0201≥0.01μF;0402≥0.033μF; 0603≥0.68μF;0805≥2.2μF 1206≥4.7μF; 1210≥22μF; TT series
10V	≤ 7.5%	≤15%	0201≥0.012μF;0402≥0.33μF; 0603≥0.33μF;0805≥2.2μF 1206≥2.2μF; 1210≥22μF
		≤20%	0201≥0.1μF ;0402≥1μF; TT series
6.3V	≤ 15%	≤30%	0201≥0.1μF;0402≥1μF;0603 ≥10μF; 0805≥4.7μF;1206≥47μF;1210≥100μF;
4V	≤20%	---	---

IR.: ≥10GΩ or RxC≥500Ω-F whichever is smaller

Moisture Resistance– Requirements –Class II-X7R

Table 10

Rated voltage	Insulation Resistance
≥100V: X7R	1GΩ or RxC≥10Ω-F whichever is smaller
50V:0603≥1μF;0805≥1μF; 1206≥4.7μF;1210≥4.7μF	
35V:0805≥2.2μF;1210≥10μF	
25V:0402≥1μF;0603≥2.2μF;0805≥2.2μF; 1206≥10μF;1210≥10μF	
16V: 0201≥0.1uF;0402≥0.22μF; 0603≥1μF;0805≥2.2μF; 1206≥10μF;1210≥47μF	
10V:0201≥47nF;0402≥0.47μF; 0603≥0.47μF;0805≥2.2μF; 1206≥4.7μF;1210≥47μF	
6.3V; 4V;	

MULTILAYER CERAMIC CHIP CAPACITORS MT SERIES
Biased Humidity- Requirements –X7R
Table 11

Rated vol.	DF ≤	Exception of DF ≤	
≥50V	≤ 3%	≤ 6%	0201(50V); 0603≥0.047μF; 0805≥0.18μF; 1206≥0.47μF;
		≤ 10%	1210≥4.7μF;
		≤ 20%	0402≥0.1μF;0603≥1μF; 0805≥1μF;1206≥2.2μF; 1210≥10μF;
35V	≤ 5%	≤20%	0603≥1μF; 0805≥2.2μF; 1210≥10μF;
25V	≤ 5%	≤10%	0201≥0.01μF; 0805≥1μF; 1210≥10μF
		≤14%	0603≥0.33μF;1206≥4.7μF
		≤15%	0402≥0.10μF;0603≥0.47μF;0805≥2.2μF;1206≥6.8μF; 1210≥22μF;
16V	≤5%	≤10%	0603≥0.15μF;0805≥0.68μF;1206≥2.2μF;1210≥4.7μF
		≤15%	0201≥0.01μF;0402≥0.033μF; 0603≥0.68μF;0805≥2.2μF 1206≥4.7μF; 1210≥22μF;
10V	≤ 7.5%	≤15%	0201≥0.012μF;0402≥0.33μF; 0603≥0.33μF;0805≥2.2μF 1206≥2.2μF; 1210≥22μF
		≤20%	0201≥0.1μF ;0402≥1μF;
6.3V	≤ 15%	≤30%	0201≥0.1μF;0402≥1μF;0603 ≥10μF; 0805≥4.7μF;1206≥47μF;1210≥100μF;
4V	≤20%	---	---

IR.: ≥10GΩ or RxC≥50Ω-F whichever is smaller

Biased Humidity- Requirements –Class II-X7R for rated voltage test
Table 12

Rated voltage	Insulation Resistance
≥100V: X7R	500MΩ or R x C ≥5 Ω-F whichever is smaller.
50V:0603≥1μF;0805≥1μF; 1206≥4.7μF;1210≥4.7μF	
35V:0805≥2.2μF;1210≥10μF	
25V:0402≥1μF;0603≥2.2μF;0805≥2.2μF; 1206≥10μF;1210≥10μF	
16V: 0201≥0.1uF;0402≥0.22μF; 0603≥1μF;0805≥2.2μF; 1206≥10μF;1210≥47μF	
10V:0201≥47nF;0402≥0.47μF; 0603≥0.47μF;0805≥2.2μF; 1206≥4.7μF;1210≥47μF	
6.3V; 4V;	

MULTILAYER CERAMIC CHIP CAPACITORS MT SERIES
Biased Humidity-- Requirements –Class II-X7R for 1.3V~1.5V
Table 13

Rated voltage	Insulation Resistance
≥100V: X7R	1GΩ or R x C ≥10 Ω-F whichever is smaller.
50V:0603≥1μF;0805≥1μF; 1206≥4.7μF;1210≥4.7μF	
35V:0805≥2.2μF;1210≥10μF	
25V:0402≥1μF;0603≥2.2μF;0805≥2.2μF; 1206≥10μF;1210≥10μF	
16V: 0201≥0.1μF;0402≥0.22μF; 0603≥1μF;0805≥2.2μF; 1206≥10μF;1210≥47μF	
10V:0201≥47nF;0402≥0.47μF; 0603≥0.47μF;0805≥2.2μF; 1206≥4.7μF;1210≥47μF	
6.3V; 4V;	

Operational Life-Requirements –X7R
Table 14

Rated vol.	DF ≤	Exception of DF ≤	
		DF ≤	Exception of DF ≤
≥50V	≤ 3%	≤ 6%	0201(50V); 0603≥0.047μF; 0805≥0.18μF; 1206≥0.47μF;
		≤ 10%	1210≥4.7μF;
		≤ 20%	0402≥0.1μF;0603≥1μF; 0805≥1μF;1206≥2.2μF; 1210≥10μF;
35V	≤ 5%	≤20%	0603≥1μF; 0805≥2.2μF; 1210≥10μF;
25V	≤ 5%	≤10%	0201≥0.01μF; 0805≥1μF; 1210≥10μF
		≤14%	0603≥0.33μF;1206≥4.7μF
		≤15%	0402≥0.10μF;0603≥0.47μF;0805≥2.2μF;1206≥6.8μF; 1210≥22μF;
16V	≤5%	≤10%	0603≥0.15μF;0805≥0.68μF;1206≥2.2μF;1210≥4.7μF
		≤15%	0201≥0.01μF;0402≥0.033μF; 0603≥0.68μF;0805≥2.2μF 1206≥4.7μF; 1210≥22μF;
10V	≤ 7.5%	≤15%	0201≥0.012μF;0402≥0.33μF; 0603≥0.33μF;0805≥2.2μF 1206≥2.2μF; 1210≥22μF
		≤20%	0201≥0.1μF ;0402≥1μF;
6.3V	≤ 15%	≤30%	0201≥0.1μF;0402≥1μF;0603 ≥10μF; 0805≥4.7μF;1206≥47μF;1210≥100μF;
4V	≤20%	---	---

IR.: ≥10GΩ or RxC≥50Ω-F whichever is smaller

MULTILAYER CERAMIC CHIP CAPACITORS MT SERIES
Operational Life-Requirements –X7R-Class II
Table 15

Rated voltage	Insulation Resistance
≥100V: X7R	1GΩ or RxC≥100Ω-F whichever is smaller
50V:0603≥1μF;0805≥1μF; 1206≥4.7μF;1210≥4.7μF	
35V:0805≥2.2μF;1210≥10μF	
25V:0402≥1μF;0603≥2.2μF;0805≥2.2μF; 1206≥10μF;1210≥10μF	
16V: 0201≥0.1μF;0402≥0.22μF; 0603≥1μF;0805≥2.2μF; 1206≥10μF;1210≥47μF	
10V:0201≥47nF;0402≥0.47μF; 0603≥0.47μF;0805≥2.2μF; 1206≥4.7μF;1210≥47μF	
6.3V; 4V;	

Moisture Resistance II, Mechanical Shock, Vibration, Resistance to Soldering Heat , Thermal Shock, Electrical Characterization-Requirements –X7R
Table 16

Rated vol.	DF ≤	Exception of DF ≤	
≥50V	≤2.5%	≤ 3%	0201(50V);0603≥0.047μF; 0805≥0.18μF; 1206≥0.47μF
		≤ 5%	1210≥4.7μF;
		≤ 10%	0402≥0.1μF;0603≥1μF; 0805≥1μF;1206≥2.2μF; 1210≥10μF;
35V	≤ 3.5%	≤10%	0603≥1μF; 0805≥2.2μF; 1210≥10μF;
25V	≤ 3.5%	≤5%	0201≥0.01μF; 0805≥1μF; 1210≥10μF
		≤7%	0603≥0.33μF;1206≥4.7μF
		≤10%	0402≥0.10μF;0603≥0.47μF;0805≥2.2μF;1206≥6.8μF; 1210≥22μF;
16V	≤3.5%	≤5%	0603≥0.15μF;0805≥0.68μF;1206≥2.2μF;1210≥4.7μF
		≤10%	0201≥0.01μF;0402≥0.033μF; 0603≥0.68μF;0805≥2.2μF 1206≥4.7μF; 1210≥22μF;
10V	≤ 5%	≤10%	0201≥0.012μF;0402≥0.33μF; 0603≥0.33μF;0805≥2.2μF 1206≥2.2μF; 1210≥22μF
		≤15%	0201≥0.1μF ;0402≥1μF;
6.3V	≤ 10%	≤15%	0201≥0.1μF;0402≥1μF;0603 ≥10μF; 0805≥4.7μF;1206≥47μF;1210≥100μF;
		≤20%	0402≥2.2μF;
4V	≤15%	---	---

IR.: ≥10GΩ or RxC≥500Ω-F whichever is smaller

MULTILAYER CERAMIC CHIP CAPACITORS MT SERIES

ESD-Requirements –X7R

Table 17

Rated vol.	DF ≤	Exception of DF ≤	
≥50V	≤2.5%	≤ 3%	0201(50V);0603≥0.047μF; 0805≥0.18μF; 1206≥0.47μF
		≤ 5%	1210≥4.7μF;
		≤ 10%	0402≥0.1μF;0603≥1μF; 0805≥1μF;1206≥2.2μF; 1210≥10μF;
35V	≤ 3.5%	≤10%	0603≥1μF; 0805≥2.2μF; 1210≥10μF;
25V	≤ 3.5%	≤5%	0201≥0.01μF; 0805≥1μF; 1210≥10μF
		≤7%	0603≥0.33μF;1206≥4.7μF
		≤10%	0402≥0.10μF;0603≥0.47μF;0805≥2.2μF;1206≥6.8μF; 1210≥22μF;
16V	≤3.5%	≤5%	0603≥0.15μF;0805≥0.68μF;1206≥2.2μF;1210≥4.7μF
		≤10%	0201≥0.01μF;0402≥0.033μF; 0603≥0.68μF;0805≥2.2μF 1206≥4.7μF; 1210≥22μF;
10V	≤ 5%	≤10%	0201≥0.012μF;0402≥0.33μF; 0603≥0.33μF;0805≥2.2μF 1206≥2.2μF; 1210≥22μF
		≤15%	0201≥0.1μF ;0402≥1μF;
6.3V	≤ 10%	≤15%	0201≥0.1μF;0402≥1μF;0603 ≥10μF; 0805≥4.7μF;1206≥47μF;1210≥100μF;
		≤20%	0402≥2.2μF;
4V	≤15%	---	---

IR.: ≥10GΩ or RxC≥50Ω-F whichever is smaller

Mechanical Shock, Vibration – Requirements –X7R-Class II

Table 18

Rated voltage	Insulation Resistance
≥100V: X7R	10GΩ or R x C ≥100 Ω-F whichever is smaller.
50V:0603≥1μF;0805≥1μF; 1206≥4.7μF;1210≥4.7μF	
35V:0805≥2.2μF;1210≥10μF	
25V:0402≥1μF;0603≥2.2μF;0805≥2.2μF; 1206≥10μF;1210≥10μF	
16V: 0201≥0.1uF;0402≥0.22μF; 0603≥1μF;0805≥2.2μF; 1206≥10μF;1210≥47μF	
10V:0201≥47nF;0402≥0.47μF; 0603≥0.47μF;0805≥2.2μF; 1206≥4.7μF;1210≥47μF	
6.3V; 4V;	

MULTILAYER CERAMIC CHIP CAPACITORS MT SERIES

Terminal Strength-Requirements –X7R

Table 19

Rated vol.	DF ≤	Exception of DF ≤	
≥50V	≤2.5%	≤ 3%	0201(50V);0603≥0.047μF; 0805≥0.18μF; 1206≥0.47μF
		≤ 5%	1210≥4.7μF;
		≤ 10%	0402≥0.1μF;0603≥1μF; 0805≥1μF;1206≥2.2μF; 1210≥10μF;
35V	≤ 3.5%	≤10%	0603≥1μF; 0805≥2.2μF; 1210≥10μF;
25V	≤ 3.5%	≤5%	0201≥0.01μF; 0805≥1μF; 1210≥10μF
16V	≤3.5%	≤5%	0201≥0.01μF;0402≥0.033μF;0603 ≥0.15μF;0805≥0.68μF; 1206≥2.2μF;1210≥4.7μF
		≤10%	0201≥0.1uF; 0402≥ 0.22uF; 0603≥0.68μF;0805≥2.2μF; 1206≥4.7μF; 1210≥22μF;
10V	≤ 5%	≤10%	0201≥0.012μF;0402≥0.33μF; 0603≥0.33μF;0805≥2.2μF 1206≥2.2μF; 1210≥22μF
		≤15%	0201≥0.1μF ;0402≥1μF;
6.3V	≤ 10%	≤15%	0201≥0.1μF;0402≥1μF;0603 ≥10μF; 0805≥4.7μF;1206≥47μF;1210≥100μF;
		≤20%	0402≥2.2μF;
4V	≤15%	---	---

Moisture Resistance II, Resistance to Soldering Heat- Requirements –X7R-Class II

Table 20

Rated voltage	Insulation Resistance
≥100V: X7R	10GΩ or R x C ≥10 Ω-F whichever is smaller.
50V:0603≥1μF;0805≥1μF; 1206≥4.7μF;1210≥4.7μF	
35V:0805≥2.2μF;1210≥10μF	
25V:0402≥1μF;0603≥2.2μF;0805≥2.2μF; 1206≥10μF;1210≥10μF	
16V: 0201≥0.1uF;0402≥0.22μF; 0603≥1μF;0805≥2.2μF; 1206≥10μF;1210≥47μF	
10V:0201≥47nF;0402≥0.47μF; 0603≥0.47μF;0805≥2.2μF; 1206≥4.7μF;1210≥47μF	
6.3V; 4V;	

MULTILAYER CERAMIC CHIP CAPACITORS MT SERIES

Thermal Shock –Requirements –X7R-Class II

Table 21

Rated voltage	Insulation Resistance
≥100V: X7R	1GΩ or R x C ≥10 Ω-F whichever is smaller.
50V:0603≥1μF;0805≥1μF; 1206≥4.7μF;1210≥4.7μF	
35V:0805≥2.2μF;1210≥10μF	
25V:0402≥1μF;0603≥2.2μF;0805≥2.2μF; 1206≥10μF;1210≥10μF	
16V: 0201≥0.1uF;0402≥0.22μF; 0603≥1μF;0805≥2.2μF; 1206≥10μF;1210≥47μF	
10V:0201≥47nF;0402≥0.47μF; 0603≥0.47μF;0805≥2.2μF; 1206≥4.7μF;1210≥47μF	
6.3V; 4V;	

ESD –Requirements –X7R-Class II

Table 22

Rated voltage	Insulation Resistance
≥100V: X7R	1GΩ or R x C ≥100 Ω-F whichever is smaller.
50V:0603≥1μF;0805≥1μF; 1206≥4.7μF;1210≥4.7μF	
35V:0805≥2.2μF;1210≥10μF	
25V:0402≥1μF;0603≥2.2μF;0805≥2.2μF; 1206≥10μF;1210≥10μF	
16V: 0201≥0.1uF;0402≥0.22μF; 0603≥1μF;0805≥2.2μF; 1206≥10μF;1210≥47μF	
10V:0201≥47nF;0402≥0.47μF; 0603≥0.47μF;0805≥2.2μF; 1206≥4.7μF;1210≥47μF	
6.3V; 4V;	

Electrical Characterization –Requirements –X7R-Class II

Table 23

Rated voltage	Insulation Resistance
≥100V: X7R	10GΩ or R x C ≥100 Ω-F whichever is smaller.
50V:0603≥1μF;0805≥1μF; 1206≥4.7μF;1210≥4.7μF	
35V:0805≥2.2μF;1210≥10μF	
25V:0402≥1μF;0603≥2.2μF;0805≥2.2μF; 1206≥10μF;1210≥10μF	
16V: 0201≥0.1uF;0402≥0.22μF; 0603≥1μF;0805≥2.2μF; 1206≥10μF;1210≥47μF	
10V:0201≥47nF;0402≥0.47μF; 0603≥0.47μF;0805≥2.2μF; 1206≥4.7μF;1210≥47μF	
6.3V; 4V; TT series	

MULTILAYER CERAMIC CHIP CAPACITORS MT SERIES

RELIABILITY TEST CONDITIONS AND REQUIREMENTS

Item	AEC-Q200 Test Condition	Requirements
Pre-and Post-Stress Electrical Test	-	
High Temperature Exposure (Storage) MIL-STD-202 Method 108	* Test temp.: $150 \pm 3^\circ \text{C}$ * Unpowered. * Test time: 1000+24/-0 hrs. * Measurement to be made after keeping at room temp. for 24 ± 2 hrs.	*No remarkable damage. *Cap change: NPO: within $\pm 2.5\%$ or $\pm 0.25\text{pF}$ whichever is larger. X7R: within $\pm 10.00\%$. * Q/D.F. value: NPO: $\text{Cap} \geq 30\text{pF}$, $\text{Q} \geq 1000$; $\text{Cap} < 30\text{pF}$, $\text{Q} \geq 400+20\text{C}$. X7R, See <Table 5> Class II (X7R) , See <Table 6>
Temperature : Cycling JESD22 Method JA-104	*Conduct 1000 cycles according to the temperatures and time. Step 1: $-55^\circ \text{C} +0/-3^\circ \text{C}$ @ 5 ± 1 min. Step 2: $+125^\circ \text{C} +3/-0^\circ \text{C}$ @ 5 ± 1 min. Before initial measurement (X7R only): Perform $150+0/-10^\circ \text{C}$ for 1 hr and then set for 24 ± 2 hrs at room temp. *Measurement to be made after keeping at room temp. for 24 ± 2 hrs.	* No remarkable damage. *Cap change: NPO: within $\pm 2.5\%$ or $\pm 0.25\text{pF}$ whichever is larger. X7R: within $\pm 10.00\%$. *Q/D.F. value: NPO: $\text{Cap} \geq 30\text{pF}$, $\text{Q} \geq 1000$; $\text{Cap} < 30\text{pF}$, $\text{Q} \geq 400+20\text{C}$ X7R, See <Table 7> Class II (X7R) , See <Table 8>

MULTILAYER CERAMIC CHIP CAPACITORS MT SERIES

RELIABILITY TEST CONDITIONS AND REQUIREMENTS

Item	AEC-Q200 Test Condition	Requirements
Destructive Physical Analysis EIA-469	Per EIA-469	No defects or abnormalities
Moisture Resistance MIL-STD-202 Method 106	Test temp.: 25~65° C Humidity: 80~100% RH Test time: 10 cycles, t=24hrs/cycle. Measurement to be made after keeping at room temp. for 24±2 hrs.	* No remarkable damage. * Cap change: NPO: within ±3.0% or ±0.30pF whichever is larger. X7R: within ±12.5%. *Q/D.F. value: NPO: More than 30pF Q≥350 ; 10pF≤C≤30pF, Q≥275+2.5C Less than 10pF Q≥200+10. X7R, See <Table 9> Class II (X7R) , See <Table 10>
Biased Humidity MIL-STD-202 Method 103	Test temp.: 85±3° C Humidity: 85%RH Test time: 1000+24/-0 hrs. To apply voltage: rated voltage and 1.3~1.5Vdc. (add 100k ohm resistor) Before initial measurement (Class II only) : To apply test voltage for 1hr at test temp. and then set for 24±2 hrs at room temp. Measurement to be made after keeping at room temp. for 24±2hrs.	* No remarkable damage. * Cap change: NPO: within ±3.0% or ±0.30pF whichever is larger. X7R: within ±12.5%. *Q/D.F. value: NPO: C≥30pF Q≥200 ; C≤30pF, Q≥100+10/3C X7R, See <Table 11> Class II (X7R) , See <Table 12> <Table 13>

MULTILAYER CERAMIC CHIP CAPACITORS MT SERIES

RELIABILITY TEST CONDITIONS AND REQUIREMENTS

Item	AEC-Q200 Test Condition	Requirements
Operational Life MIL-STD-202 Method 108	Test temp.: $125 \pm 3^\circ \text{C}$ To apply voltage: full rated voltage. * Test time: 1000+24/-0 hrs. Before initial measurement (X7R only): Apply rated voltage for 1 hr at 125°C . Remove and let set for 24 ± 2 hrs at room temp. Measurement to be made after keeping at room temp. for 24 ± 2 hrs.	* No remarkable damage. * Cap change: NPO: within $\pm 3.0\%$ or $\pm 0.30\text{pF}$ whichever is larger. X7R: within $\pm 12.5\%$. *Q/D.F. value: NPO: More than 30pF $Q \geq 350$; $10\text{pF} \leq C \leq 30\text{pF}$, $Q \geq 275 + 2.5C$ Less than 10pF $Q \geq 200 + 10$. X7R, See <Table 14> Class II (X7R) , See <Table 15>
External Visual MIL-STD-883 Method 2009	Visual inspection	No remarkable defect.
Physical Dimension JESD22 Method JB-100	Using by calipers	Within the specified dimensions
Moisture Resistance II MIL-STD-202 Method 106	* Temperature: $25 \pm 5^\circ \text{C}$ * Time: $3 + 0.5 / - 0$ min. *Solvent: Iso - propyl alcohol.	* No remarkable damage. * Cap change: within the specified tolerance. *Q/D.F. value: NPO: $\text{Cap} \geq 30\text{pF}$, $Q \geq 1000$; $\text{Cap} < 30\text{pF}$, $Q \geq 400 + 20C$ X7R, See <Table 16> Class II (X7R) , See <Table 20>

MULTILAYER CERAMIC CHIP CAPACITORS MT SERIES

RELIABILITY TEST CONDITIONS AND REQUIREMENTS

Item	AEC-Q200 Test Condition	Requirements
Mechanical Shock IL-STD-202 Method 213	Peak value: 1500g's. Wave: 1/2 sine. Velocity: 15.4 ft/sec Three shocks in each direction should be applied along 3 mutually perpendicular axes of the test specimen (18 shocks)	* No remarkable damage. * Cap change: within the specified tolerance. *Q/D.F. value: NPO: Cap \geq 30pF, Q \geq 1000 ; Cap $<$ 30pF, Q \geq 400+20C X7R, See <Table 16> Class II (X7R) , See <Table 18>
Vibration MIL-STD-202 Method 204	Vibration frequency:10~2000Hz/min. (5g's for 20 min) Total amplitude: 1.5mm 12 cycles each of 3 orientations (36 times)	* No remarkable damage. * Cap change: within the specified tolerance. *Q/D.F. value: NPO: Cap \geq 30pF, Q \geq 1000 ; Cap $<$ 30pF, Q \geq 400+20C X7R, See <Table 16> Class II (X7R) , See <Table 18>
Resistance to Soldering Heat MIL-STD-202 Method 210	*Solder temperature: 270 \pm 5 $^{\circ}$ C *Dipping time: 10 \pm 1 sec *Before initial measurement (X7R only): Perform 150+0/-10 $^{\circ}$ C for 1 hr and then set for 24 \pm 2 hrs at room temp. * Measurement to be made after keeping X7R: at room temp. for 24 \pm 2 hrs.	* No remarkable damage. * Cap change: NPO: within \pm 2.5% or 0.25pF whichever is larger X7R: within \pm 7.5% *Q/D.F. value: NPO: Cap \geq 30pF, Q \geq 1000 ; Cap $<$ 30pF, Q \geq 400+20C X7R, See <Table 16> Class II (X7R) , See <Table 20>

MULTILAYER CERAMIC CHIP CAPACITORS MT SERIES

RELIABILITY TEST CONDITIONS AND REQUIREMENTS

Item	Test Condition	Requirements
Thermal Shock II-STD-202 Method 107	<p>*Conduct 300 cycles according to the temperatures and time. transfer time: 20 sec.</p> <p>Step 1: -55° C +0/-3° C @ 15±3 min.</p> <p>Step 2: +125° C +3/-0° C @ 15±3 min.</p> <p>*Max.transfer time:20 sec</p> <p>*Before initial measurement (X7R only): Perform 150+0/-10° C for 1 hr and then set for 24±2 hrs at room temp.</p> <p>*Measurement to be made after keeping at room temp. for 24±2 hrs</p>	<p>* No remarkable damage.</p> <p>* Cap change: NPO: within ±2.5% or 0.25pF whichever is larger X7R: within ±10.0%</p> <p>*Q/D.F. value: NPO: Cap≥30pF, Q≥1000 ; Cap<30pF, Q≥400+20C X7R, See <Table 16> Class II (X7R) , See <Table 21></p>
ESD AEC-Q200-002	<p>Per AEC-Q200-002</p>	<p>* No remarkable damage.</p> <p>* Cap change: within the specified tolerance.</p> <p>*Q/D.F. value: NPO: Cap≥30pF, Q≥1000 ; Cap<30pF, Q≥400+20C X7R, See <Table 17> Class II (X7R) , See <Table 22></p>
Solderability J-STD-002 JESD22-B102E	<p>*Condition A Un-mounted chips 4hrs / 155° C</p> <p>*dry then completely immersed for 5±0.5 sec in solder bath at 245±5° C.</p> <p>*Condition B Un-mounted chips steam 8 hrs then completely immersed for 10±1sec in solder bath at 220+5/-0° C.</p> <p>*Condition C Un-mounted chips steam 8 hrs then completely immersed for 10±1 sec. in solder bath at 260+0/-5° C.</p>	<p>All terminations shall exhibit a continuous solder coating free from defects from a minimum of 95% of the critical surface area of any individual termination.</p>

MULTILAYER CERAMIC CHIP CAPACITORS MT SERIES

RELIABILITY TEST CONDITIONS AND REQUIREMENTS

Item	Test Condition	Requirements
<p>Electrical Characterization</p>	<p>*Capacitance</p> <p>*Q/ D.F. (Dissipation Factor) Cap≤1000pF 1.0±0.2Vrms, 1MHz±10%</p> <p>Cap>1000pF 1.0±0.2Vrms, 1KHz±10%</p> <p>*Insulation Resistance To apply rated voltage(500V max.) for max. 120 sec.</p> <p>*Dielectric Strength To apply voltage: ≤100 ≥2.5 times VDC 200V~300V ≥2 times VDC 400V~450V ≥1.2 times VDC 500V~999V ≥1.5 times VDC 1000V~3000V ≥1.2 times VDC , duration 1~5 sec, charge and discharge current less than 50mA.</p> <p>*Temperature Coefficient (with no electrical load) Operation temperature: -55~125° C at 25° C</p>	<p>* Cap change: within the specified tolerance.</p> <p>*Q/D.F. value: NPO: Cap≥30pF, Q≥1000 ; Cap<30pF, Q≥400+20C X7R, See <Table 16> Class II (X7R) , See <Table 23></p> <p>*Dielectric strength No evidence of damage or flash over during test.</p> <p>*Temperature Coefficient Capacitance Change: NPO: Within ±30ppm/° C X7R: Within ±15%</p>
<p>Board Flex AEC-Q200-005</p>	<p>* The middle part of substrate shall be pressurized by means of the pressurizing rod at a rate of about 1 mm per second until the deflection becomes 3mm (2mm for X7R) and then the pressure shall be maintained for 5±1 sec.</p> <p>* Measurement to be made after keeping at room temp. for 24±2 hrs.</p>	<p>* No remarkable damage.</p> <p>*Cap change: NPO: within ±5.0% or ±0.5pF whichever is larger. X7R: within ±12.5%. (This capacitance change means the change of capacitance under specified flexure of substrate from the capacitance measured before the test.)</p>

MULTILAYER CERAMIC CHIP CAPACITORS MT SERIES

RELIABILITY TEST CONDITIONS AND REQUIREMENTS

Item	Test Condition	Requirements
Terminal Strength AEC-Q200-006	* Pressurizing force: 2N (0402), 10N(0603) 18N(0805). * Test time: 60 ± 1 sec.	*No remarkable damage or removal of the terminations. * Capacitance within the specified tolerance * Q/D.F. value: NPO: Cap≥30pF, Q≥1000 ; Cap<30pF, Q≥400+20C X7R, See <Table 19>
Beam Load Test AEC-Q200-003	* Break strength test * Beam speed: 2.5 ± 0.25 mm/se	The chip endure following force * Chip length ≤2.5mm: Thickness >0.5mm (20N), ≤0.5mm (8N) * Chip length ≥3.2mm: Thickness ≥1.25mm (54.5N), <1.25mm (15N)

MULTILAYER CERAMIC CHIP CAPACITORS MT SERIES

RECOMMENDED PROFILE CONDITIONS

The lead-free termination MLCCs are not only to be used on SMT against lead-free solder paste, but also suitable against lead-containing solder paste.

If the optimized solder joint is requested, increasing soldering time, temperature and concentration of N2 within oven are recommended.

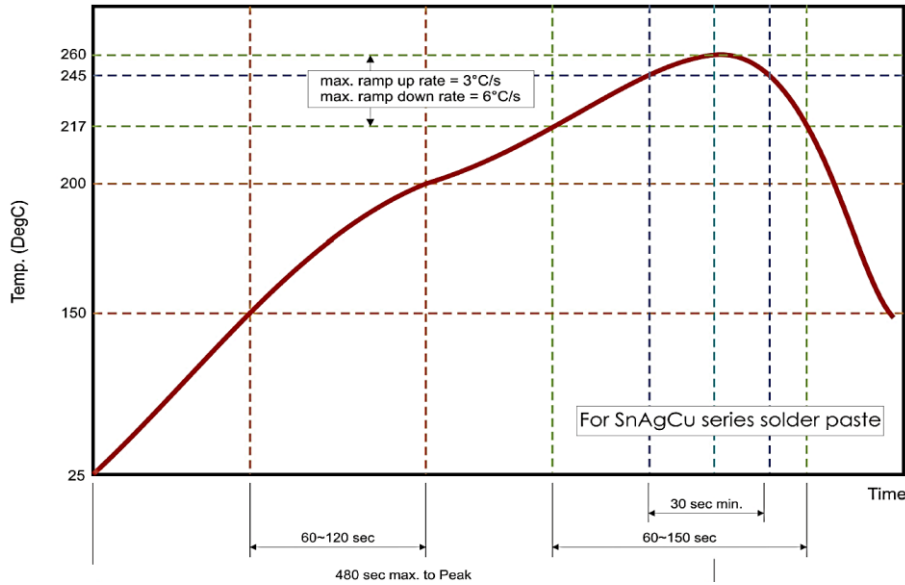

Reflow Soldering Profile For SMT Process with SnAgCu series Solder Paste

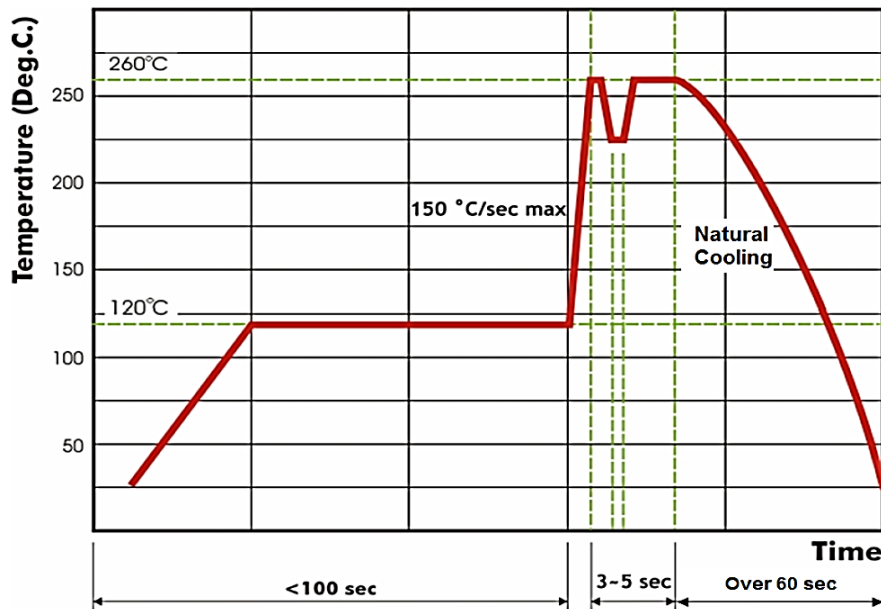

Wave Soldering Profile For SMT Process with SnAgCu series Solder Paste

MULTILAYER CERAMIC CHIP CAPACITORS MT SERIES

PACKAGING STYLE AND QUANTITY

Size	Thickness (Symbol)		Paper Tape		Plastic Tape	
			7" Reel	13" Reel	7" Reel	13" Reel
0201 (0603)	0.30±0.03	L	15,000	70,000	-	-
0402 (1005)	0.50±0.05	N	10,000	50,000		
0603 (1608)	0.80±0.07	S	4,000	15,000		
	0.80+0.15/-0.10	X	4,000	15,000		
0805 (2012)	0.60±0.10	A	4,000	15,000		
	0.85±0.10	B	4,000	15,000		
	1.25±0.10	D			3,000	10,000
	1.25±0.20	I			3,000	10,000
1206 (3216)	0.80±0.10	B	4,000	15,000		
	0.95±0.10	C			3,000	10,000
	1.15±0.15	J			3,000	10,000
	1.25±0.10	D			3,000	10,000
	1.60±0.20	G			2,000	10,000
	1.60+0.30/-0.10	P			2,000	9,000
1210 (3225)	0.95±0.10	C			3,000	10,000
	1.25±0.10	D			3,000	10,000
	1.60±0.20	G			2,000	
	2.00±0.20	K			1,000	6,000
	2.50±0.30	M			1,000	6,000

MULTILAYER CERAMIC CHIP CAPACITORS MT SERIES

REEL DIMENSION (Unit: mm)

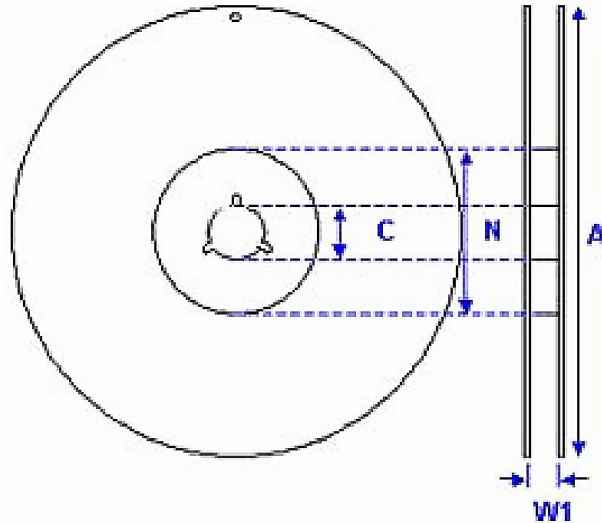

Size Code	0201, 0402, 0603, 0805, 1206, 1210		
Reel Size	7"	10"	13"
C	13.0+0.5/-0.2	13.0+0.5/-0.2	13.0+0.5/-0.2
W 1	8.4+1.5/0	8.4+1.5/-0	8.4+1.5/-0
A	178.0±0.10	250.0±1.0	330.0±1.0
N	60.0+1.0/-0	100.0±1.0	100±1.0

TAPE DIMENSION (Unit: mm)

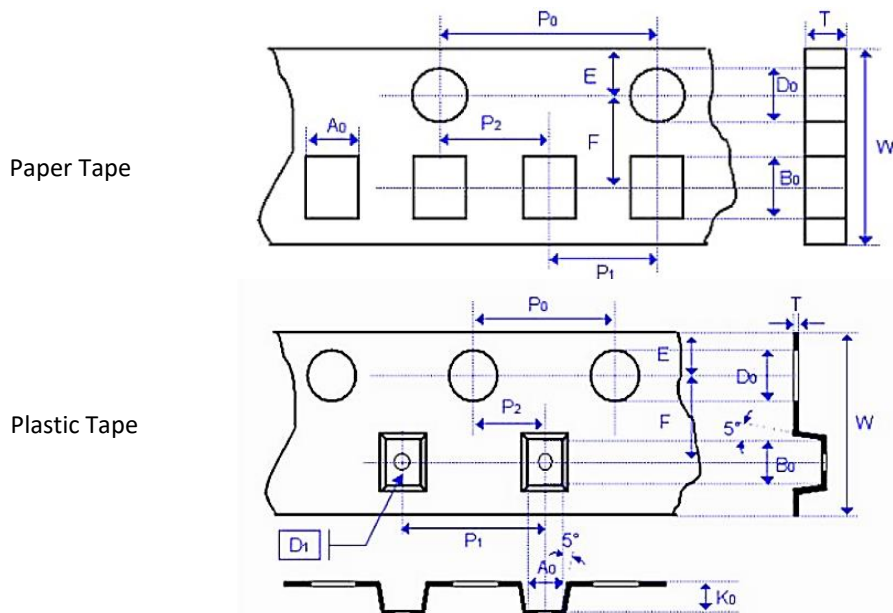

MULTILAYER CERAMIC CHIP CAPACITORS MT SERIES
TAPE DIMENSION (Unit: mm)

Size	0201	0402	0603	0805		
Thickness	L	N, E	S, H, X	A, H	B, T	D, I
A0	0.39+/-0.07	0.70+/-0.2	1.05+/-0.30	1.50+/-0.20	1.50+/-0.20	< 1.80
B0	0.69+/-0.07	1.20+/-0.2	1.80+/-0.30	2.30+/-0.20	2.30+/-0.20	< 2.70
T	≤0.50	≤0.80	≤1.20	≤1.15	≤1.30	0.23+/-0.1
W	8.00+/-0.10	8.00+/-0.10	8.00+/-0.10	8.00+/-0.10	8.00+/-0.10	8.00+/-0.20
P0	4.00+/-0.10	4.00+/-0.10	4.00+/-0.10	4.00+/-0.10	4.00+/-0.10	4.00+/-0.10
10xP0	40.00+/-0.10	40.00+/-0.10	40.00+/-0.20	40.00+/-0.20	40.00+/-0.20	40.00+/-0.20
P1	2.00+/-0.05	2.00+/-0.05	4.00+/-0.10	4.00+/-0.10	4.00+/-0.10	4.00+/-0.10
P2	2.00+/-0.05	2.00+/-0.05	2.00+/-0.05	2.00+/-0.05	2.00+/-0.05	2.00+/-0.05
D0	1.55+/-0.05	1.55+/-0.05	1.55+/-0.05	1.55+/-0.05	1.55+/-0.05	1.50+0.1/-0
D1	-	-	-	-	-	1.00+/-0.10
E	1.75+/-0.05	1.75+/-0.05	1.75+/-0.05	1.75+/-0.05	1.75+/-0.05	1.75+/-0.10
F	3.50+/-0.05	3.50+/-0.05	3.50+/-0.05	3.50+/-0.05	3.50+/-0.05	3.50+/-0.05

Size	1206			1210		
Thickness	B, T	C, J, D	G, P	T	C, D, G, K	M
A0	1.90 +/-0.50	< 2.00	< 2.30	< 3.05	< 3.05	< 3.20
B0	3.50 +/-0.50	< 3.70	< 4.00	< 3.80	< 3.80	< 3.95
T	≤1.30	0.23 +/-0.1	0.23 +/-0.1	0.23 +/-0.1	0.23 +/-0.1	0.23 +/-0.1
W	8.00 +/-0.10	8.00 +/-0.20	8.00 +/-0.20	8.00 +/-0.20	8.00 +/-0.20	8.00 +/-0.20
P0	4.00 +/-0.10	4.00 +/-0.10	4.00 +/-0.10	4.00 +/-0.10	4.00 +/-0.10	4.00 +/-0.10
10xP0	40.0 +/-0.20	40.0 +/-0.20	40.0 +/-0.20	40.0 +/-0.20	40.0 +/-0.20	40.0 +/-0.20
P1	4.00 +/-0.10	4.00 +/-0.10	4.00 +/-0.10	4.00 +/-0.10	4.00 +/-0.10	4.00 +/-0.10
P2	2.00 +/-0.05	2.00 +/-0.05	2.00 +/-0.05	2.00 +/-0.05	2.00 +/-0.05	2.00 +/-0.05
D0	1.50 +0.1/-0	1.50 +0.1/-0	1.50 +0.1/-0	1.50 +0.1/-0	1.50 +0.1/-0	1.50 +0.1/-0
D1	-	1.00 +/-0.10	1.00 +/-0.10	1.00 +/-0.10	1.00 +/-0.10	1.00 +/-0.10
E	1.75 +/-0.05	1.75 +/-0.10	1.75 +/-0.10	1.75 +/-0.10	1.75 +/-0.10	1.75 +/-0.10
F	3.50 +/-0.05	3.50 +/-0.05	3.50 +/-0.05	3.50 +/-0.05	3.50 +/-0.05	3.50 +/-0.05

MULTILAYER CERAMIC CHIP CAPACITORS MT SERIES

STORAGE AND HANDLING CONDITIONS

- (1) To store products at 5 to 40°C ambient temperature and 20 to 70% related humidity conditions.
- (2) The product is recommended to be used within one year after shipment. Check solder ability in case of shelf life extension is needed.

CAUTIONS

- (1) The corrosive gas reacts on the terminal electrodes of capacitors, and results in the poor solder ability. Do not store the capacitors in the ambience of corrosive gas (e.g., hydrogen sulfide, sulfur dioxide, chlorine, ammonia gas etc.)
- (2) In corrosive atmosphere, solder ability might be degraded, and silver migration might occur to cause low reliability.
- (3) Due to the dewing by rapid humidity change, or the photochemical change of the terminal electrode by direct sun light, the solder ability and electrical performance may deteriorate. Do not store capacitors under direct sunlight or dewing condition. To store products on the shelf and avoid exposure to moisture.

DISCLAIMER

NextGen Component, Inc. reserves the right to make changes to the product(s) and or information contained herein without notice. No liability is assumed as a result of their use or application. No rights under any patent accompany the sale of any such product(s) or information