

# Specification

Drawing No.	TKY1T-H1-23014-00[43]
Issued Date.	January 27, 2023

**TO: Digi-Key**

Note: In case of specification change, KYOCERA Part Number also will be changed.

Product Name	Crystal Oscillator
Product Model	_____
Frequency	26.0000 MHz
Customer Part Number	_____
Customer Specification Number	_____
KYOCERA Part Number	KC3225Z26.0000C1GX00
Remarks	RoHS Compliant / MSL 1



## Customer Acceptance

Accept Signature	Accept Date	
	Department	
	Person in charge	

## Seller

KYOCERA Corporation  
Corporate Electronic Components Group  
Electronic Components Sales Division  
6 Takeda Tobadono-cho, Fushimi-ku, Kyoto  
612-8501 Japan  
TEL. No. 075-604-3500  
FAX. No. 075-604-3501

KYOCERA Corporation  
Corporate Electronic Components Group  
RF Devices Division  
Yamagata higashine Plant  
5850, Higashine-koh, Higashine-shi, Yamagata  
999-3701 Japan  
TEL. No. 0237-43-5611  
FAX. No. 0237-43-5615

Design Department	Quality Assurance	Approved by	Examined by	Written by
Crystal Components Application Engineering Section2 RF Devices Engineering Department 1 RF Devices Division	Y.Kakuta 	T.Koyanagi 	K.Jikuhara 	T.Sakumai 

**KYOCERA Corporation**

Drawing No.	TKY1T-H1-23014-00[43]
-------------	-----------------------

**Revision History**

Rev.No.	Description of revise	Date	Approved by	Examined by	Written by
00	First Edition	Jan. 27, 23	T.Koyanagi	K.Jikuhara	T.Sakuma

## 1. Scope

This specification shall be defined of the Clock Oscillator for the integrated circuits (ICs).

## 2. Customer Part Number

-----

## 3. KYOCERA Part Number

**KC3225Z26.0000C1GX00**

## 4. Electrical Characteristics

### 4-1. Absolute Maximum Rating

Item	Symbol	Rated Value	Units
Power Supply Voltage	$V_{CC}$	-0.3 to +4.5	V
Input Voltage	$V_{IN}$	-0.3 to $V_{CC} + 0.3$	V
Storage Temperature	$T_{STG}$	-55 to +150	°C

Note:

If the part is used beyond absolute maximum ratings, it may cause internal destruction. The part should be used under the recommended operating conditions the reliability of this part may be damaged if those conditions are exceeded.

### 4-2. Recommended Operating Conditions

Item	Symbol	Min	Typ	Max	Units	Remarks
Power Supply Voltage	$V_{CC}$	1.71	3.3	3.63	V	
Input Voltage	$V_{IN}$	0	---	$V_{CC}$	V	
Operating Temperature	$T_{OPR}$	-40	+25	+85	°C	

### 4-3. Electrical Characteristics

Item	Symbol	Min	Typ	Max	Units	Remarks
Output Frequency	$F_O$	---	26	---	MHz	
Frequency Tolerance*	$F_{tol}$	-50	---	+50	ppm	
Current Consumption (No-Load/ $1.71 \leq V_{CC} \leq 2.25V$ )	$I_{CC}$	---	---	6.2	mA	
Current Consumption (No-Load/ $2.25 < V_{CC} \leq 2.8V$ )		---	---	6.5		
Current Consumption (No-Load/ $2.8 < V_{CC} \leq 3.63V$ )		---	---	7.3		
Standby Current	$I_{ST}$	---	---	5	$\mu A$	
Symmetry (Duty Ratio)	SYM	45	50	55	%	@ 50% $V_{CC}$
Rise Time/ Fall Time (20% $V_{CC}$ to 80% $V_{CC}$ ) Loaded	Tr/ Tf	---	---	4.0	ns	$1.71 \leq V_{CC} \leq 2.25V$
		---	---	3.0		$2.25 < V_{CC} \leq 2.8V$
		---	---	2.5		$2.8 < V_{CC} \leq 3.63V$
Output Voltage-"L"	$V_{OL}$	---	---	10% $V_{CC}$	V	$I_{OL} = 4mA$
Output Voltage-"H"	$V_{OH}$	90% $V_{CC}$	---	---		$I_{OH} = -4mA$
Output Load	CL	---	---	15	pF	CMOS
Input Voltage-"L"	$V_{IL}$	---	---	30% $V_{CC}$	V	
Input Voltage-"H"	$V_{IH}$	70% $V_{CC}$	---	---		
Output Disable Time	$t_{dis}$	---	---	200	ns	
Output Enable Time	$t_{ena}$	---	---	5	ms	
Start-up Time	$t_{sta}$	---	---	5	ms	@Minimum operating voltage to be 0sec
1 Sigma Jitter**	$J_{Sigma}$	---	---	12	ps	
Peak to Peak Jitter**	$J_{PK-PK}$	---	---	95	ps	
Phase Jitter (BW:12kHz to 20MHz)	---	---	---	36	ps	$V_{CC} = 1.8V$
		---	---	36		$V_{CC} = 2.5V$
		---	---	36		$V_{CC} = 3.3V$

Note: All electrical characteristics have defined on the maximum loaded and recommended operating conditions.

\*Over All Conditions:

Include initial tolerance, operating temperature range, rated power supply voltage change, load change, aging (1year @+25°C), shock and vibration

\*\*Based on Time Interval Analyzer "Wavecrest SIA-3000".

**Table 1**

4-4. Measurement Condition

The reference temperature shall be +25±2°C. The measurement shall be performed at the temperature range of +5 °C to +35 °C unless otherwise the result is doubtful.

4-5. Measurement Circuit

The electrical characteristics shall be measured by test circuit "Fig. 1". Also jitter shall be measured by test circuit "Fig. 3".

4-6. Clock Timing Chart

The clock timing chart is "Fig. 2".

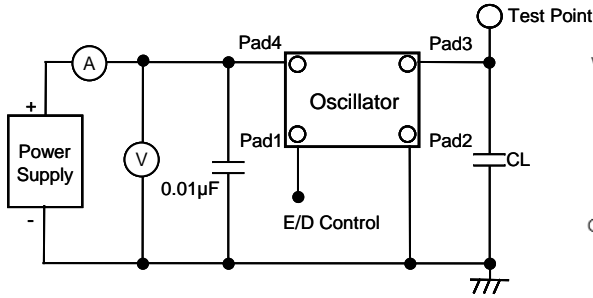

Note: CL includes probe and test fixture capacitance

**Fig.1 Test Circuits**

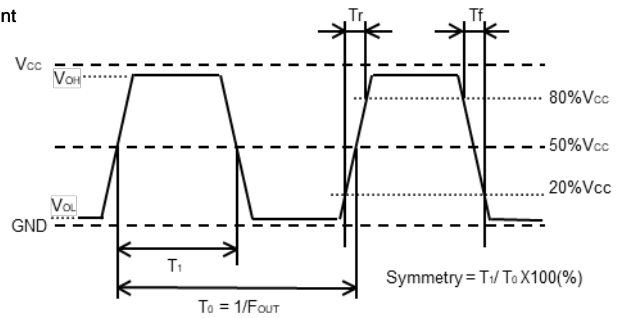

**Fig.2 Clock Timing Chart (C-MOS Output)**

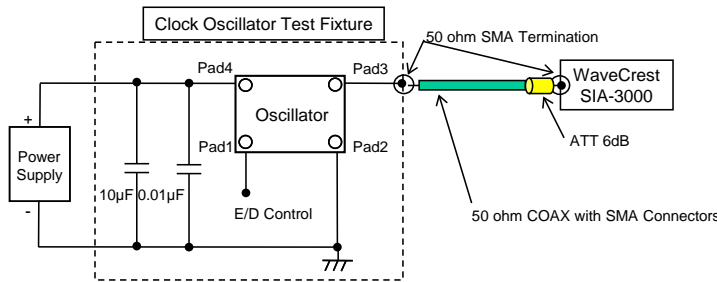
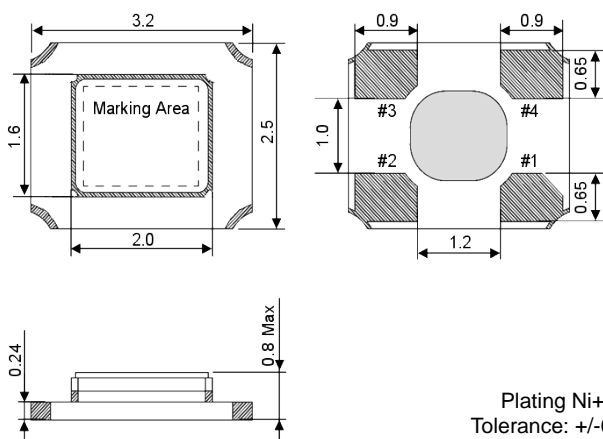

**Fig.3 Jitter Test Circuits**

<Measurement Conditions>

- Time Interval Analyzer
  - WaveCrest SIA-3000
- DTS timer calibration
  - Over 30 minutes warm-up
  - Extend 30 minutes calibration
- Jitter histogram conditions (Tail-fit)
  - More than 50,000cyc Hits
  - Bit Error Ratio (BER) -12 (14sigma)

5. Dimensions and Marking



Plating Ni+Au  
Tolerance: +/-0.1  
Unit:(mm)

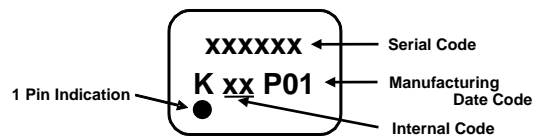

Manufacturing Date Code

- 1) Year Code (2000: "Z", 2001:"A", 2002: "B" ....)
- 2) Weekly Code

Year	Code	Year	Code
2020	W	2031	L
2021	A	2032	M
2022	B	2033	N
2023	C	2034	P
2024	D	2035	Q
2025	E	2036	R
2026	F	2037	S
2027	G	2038	T
2028	H	2039	V
2029	J	2040	W
2030	K	2041	A

It repeats from A in 2041 and after wards.

**Table 2**

Pad arrangement	
1	Stand-by Function
2	Case GND
3	Output
4	V <sub>CC</sub>

Stand-by Function	
Pad1	Pad3 (Output)
OPEN	Active
"H" Level	Active
"L" Level	High Z (No-Oscillation)

## 6. Parts Numbering Guide

**KC3225Z 26.0000 C 1 G X 00**  
**A B C D E F G**

- A. Series (SMD Oscillator)  
 B. Output Frequency(MHz)  
 (\*Indicated with 7 digits.)  
 C. Output  
 C: C-MOS  
 D. Supply Voltage  
 1: 1.8V/ 2.5V/ 3.3V Compatible  
 E. Frequency Tolerance\*  
 G:±50ppm

- F. Symmetry (Duty Ratio) and Stand-by Function  
 X: Symmetry: 45% to 55% with Stand-by Function  
 G. Suffix for Individual Requirements  
 (STD Specification is "00")

Packing (Tape & Reel 2,000pcs/Reel or 15,000pcs/Reel)

\*Over All Conditions:

Include initial tolerance, operating temperature range,  
 rated power supply voltage change, load change,  
 aging (1year @+25°C), shock and vibration.

## 7. Environmental Characteristics

Items	Conditions	Criteria of Acceptance
7-1. Solderability	Soaking: +245±5°C, 5.0±0.5sec	Dipped potion: Minimum 95% coverage
7-2. Soldering Heat Resistance	Reflow soldering: Peak +260°C max, 10sec, Twice max	Without looseness or crack etc.
7-3. Temperature Cycle	10 cycles: -55°C to +125°C (30minuts each/ cycle)	Clause 7-10 shall be satisfied.
7-4. Mechanical Shock (Pulse)	5 times 14,750m/sec <sup>2</sup> (1,500G), Duration of pulse 0.5msec (MIL-STD-883D-2002.3 Condition B)	
7-5. Vibration	4 times each axis X, Y, Z: 20 to 2,000Hz and 2,000Hz to 20Hz/cycle Peak acceleration 196m/sec <sup>2</sup> (20G) (MIL-STD-883D-2007.2 Condition A)	
7-6. High Temperature	1000 hours: Temperature: +85+5/-3°C	
7-7. Low Temperature	1000 hours: Temperature: -40+5/-3°C	Clause 7-1 shall be satisfied.
7-8. Humidity Cycle	10 cycles: Based on 1004 specifications (MIL-STD-883D-1004.7)	
7-9. Hermeticity 1 (Gross leak)	Soaking: +125°C, 5minutes	No bubbles appeared
7-10. Hermeticity 2 (Fine leak)	Measured by Helium Detector Equipment (MIL-STD-883D-1014.10 Condition A1)	5x10 <sup>-9</sup> Pa m <sup>3</sup> /sec max

After each testing, the parts shall be subjected to standard atmospheric conditions more than 2 hours. After that, the electrical characteristics shall be measured. The result of the test shall be satisfied **Table 1**.

**Table 3**

### 8. Recommended Land pattern and Soldering Guide

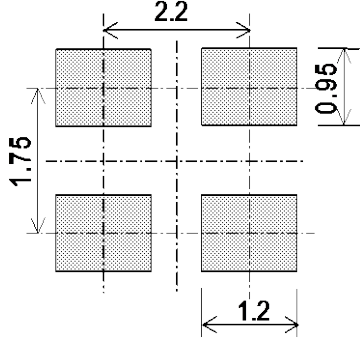

Unit: (mm)

Note:  
 Since the part doesn't have Bypass Capacitor between  $V_{cc}$  and GND, Please mount high frequency type capacitor  $0.01\mu F$  to the nearest position of oscillator.

**Fig.4 Land pattern**

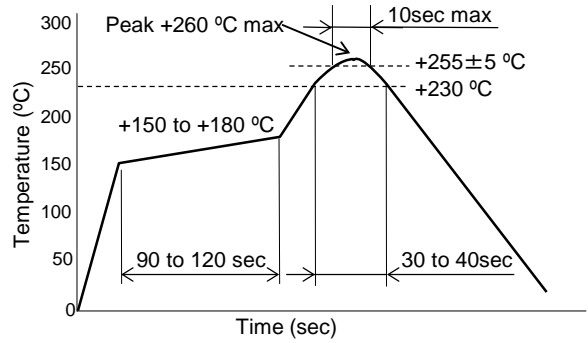

- Available Reflow times: Maximum twice

**Fig.5 Reflow profile (Lead Free Available)**

### 9. Taping Specifications

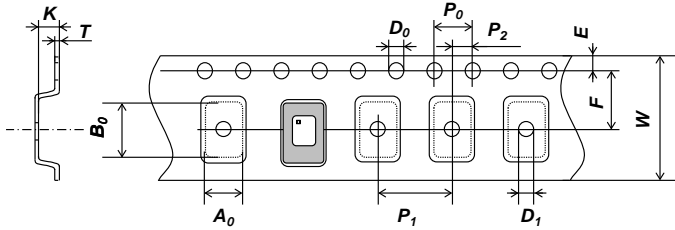

Unit: (mm)

Symbol	<b>A<sub>0</sub></b>	<b>B<sub>0</sub></b>	<b>W</b>	<b>F</b>	<b>E</b>
Dimensions	2.8±0.05	3.5±0.05	8.0±0.2	3.5±0.05	1.75±0.1
Symbol	<b>P<sub>1</sub></b>	<b>P<sub>2</sub></b>	<b>P<sub>0</sub></b>	<b>D<sub>0</sub></b>	<b>T</b>
Dimensions	4.0±0.1	2.0±0.05	4.0±0.1	1.5+0.1/-0	0.25±0.05
Symbol	<b>K</b>	<b>D<sub>1</sub></b>			
Dimensions	1.0±0.05	1.55±0.05			

**Fig.6 Emboss Carrier Tape**

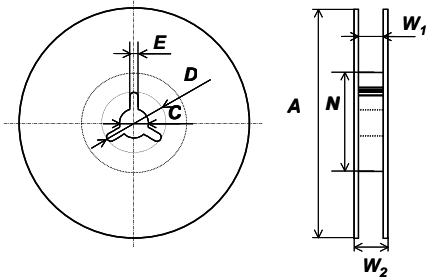

Std. Max 2,000pcs/Reel

Unit: (mm)

Symbol	<b>A</b>	<b>N</b>	<b>W<sub>1</sub></b>
Dimensions	180 +0/-1.5	60+1/-0	9.0+0.3/-0
Symbol	<b>W<sub>2</sub></b>	<b>C</b>	<b>D</b>
Dimensions	11.4±1.0	13.0±0.2	21.0±0.8
Symbol	<b>E</b>		
Dimensions	2.0±0.5		

Option Max 15,000pcs/Reel

Unit: (mm)

Symbol	<b>A</b>	<b>N</b>	<b>W<sub>1</sub></b>
Dimensions	330 +0/-2	100+1/-1	9.4+1/-0.5
Symbol	<b>W<sub>2</sub></b>	<b>C</b>	<b>D</b>
Dimensions	---	13.0±0.2	21.0±0.8
Symbol	<b>E</b>		
Dimensions	2.0±0.5		

**Fig.7 Reel**

#### 9-1. Taping Quantities

- The taping of per reel shall be packed 2,000 pcs (Std) or 15,000 pcs (Option).
- The parts shall be contained continuously in the pocket.

#### 9-2. Leader and Blank Pockets

- The package shall be consisted of leader, blank pockets and loaded pocket as follows "Fig. 8".
- The power of peeling strength between top tape and carrier tape shall be 0.1N(10gf) to 1.0N(100gf) as follows "Fig. 9".

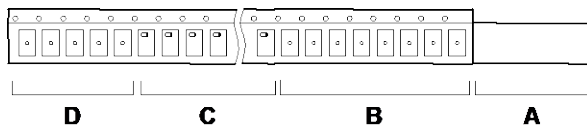

- A) Leader
- B) Blank Pocket (40mm to 320mm)  
A+B: 400mm to 560mm
- C) Load Pocket
- D) Blank Pocket (160mm minimum)

**Fig.8 Packing Method**

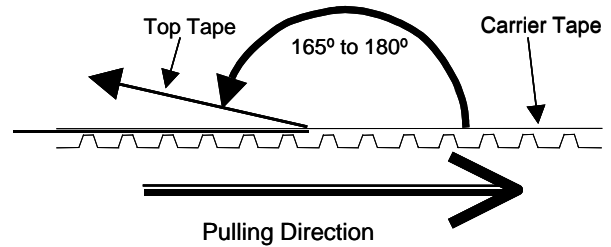

**Fig.9 Peeling Strength**

### 9-3. Reel Label

The reel label shall be consisted as below. (Based on EIAJ C-3 format)

- A) Customer Part Number
- B) Lot No.
- C) Quantities
- D) Shipping Date
- E) Vender Name

### 9-4. Exterior Package Label

The oscillator shall be packed properly to avoid defect in transportation. The exterior package label shall be consisted as below.

- A) Name of Customer
- B) P/O No.
- C) Customer Part Number
- D) Lot No.
- E) Quantities
- F) Shipping Date
- G) Vender Name

## 10. The agreement of this specifications

In case there is any obscure point or doubt concerning the contents of the specification, it shall be settled through consultation of both parties.

## 11. Remarks on Usages

### A) Storage Conditions

The parts shall be stored in temperature range of -5 to +40°C, humidity 40 to 60% RH, and avoid direct sunlight. Then the parts shall be used within 6 months.

### B) Handling Conditions

Although the part has protection circuit against static electricity, when excess static electricity is applied, the inside IC may get damaged.

Before mounting on the PCB, please make sure the direction of the part is correct. Otherwise the part of temperature will increase. And also the part will have some damages.

Please do not use the parts under the unfavorable condition such as beyond specified range in this specification.

Please do not use the parts under the condition, in the water or in the salt water also environment of dew or harmful gas.

Frequency drift may occur as a result of application of light such as direct sunlight or LED light etc when operating this oscillator.

Please use in a design and environment that consider light shielding.

Note the frequency drift will not occur if used in a light-shielded environment.

Please make sure the condition of pick and place following pick up nozzle guideline.

Picking Method: Case of Head Unit 1.6 x 1.2mm (Inside Diameter)

The proper condition of pick and place will be different each equipment. Therefore, please check before testing.

This product can be used for general electronic equipment (information equipment, communication equipment, audiovisual equipment, measuring equipment, home appliances, etc.)Intended to be used. Equipment and systems (traffic equipment, safety equipment, aviation / space control, nuclear power control, life support equipment) that require special quality and reliability and whose failure or malfunction may endanger human life or harm the human body. (Including medical devices, etc.), basic driving functions (running, turning, stopping) and collision safety in traffic equipment, applications related directly or indirectly to collision safety, and applications that are expected to have a significant impact on property, etc. It is not intended to be used.In the unlikely event that this product is used for any of these purposes, we will not be liable for any damages resulting from such use.

- C) Rework Condition  
Please do not pick up Head Unit. We can't guaranty electrical performance and reliability.
- D) Soldering Conditions  
This product can respond to the general Pb-free reflow profile. The wave soldering cannot be supported.
- E) Soldering in Mounting  
In case of Solder paste and conductive glue contact product lid or product side face exception for product terminal it's possible to influence product characteristics.  
Please be careful above contents.
- F) Washing Conditions  
Ultra sonic cleaning is available. However there is a possibility that Crystal in the part may cause damaged under certain condition. Therefore please test before using.  
After washing, please dry the parts completely. Otherwise water drops between the parts and PCB may cause migration.

In case of using this part without above precaution, Kyocera is unable to guarantee the specific characteristics

## 12. Quality guarantee

In case when Kyocera Corporation rooted failure occurred within 1year after its delivery, substitute product will be arranged based on discussion. Quality guarantee of product after 1year of its delivery is waived.