



SPECIFICATION SHEET

SPECIFICATION SHEET NO.	Q0606- CRUR05BB301RS1
DATE	June. 6, 2023
REVISION	A0
DESCRIPTION	Thin Film Chip Resistors, 0805 (2012 Metric), UR05 Series, Dimension L2.00*W1.25*H0.50mm, 2 Terminations, Tolerance: $\pm 0.1\%$, Resistance 301 ohm, Dissipation Max. 1/10W @ 70°C, Temperature Coefficient Rate (TCR) Max. $\pm 25\text{ppm}/^\circ\text{C}$ Operating Temp. Range $-55^\circ\text{C} \sim +155^\circ\text{C}$ Package in Tape/Reel, 5,000pcs/Reel RoHS/RoHS III compliant and HF
CUSTOMER	
CUSTOMER PART NUMBER	
CROSS REF. PART NUMBER	
ORIGINAL PART NUMBER	Aillen UR05BB301R
PART CODE	CRUR05BB301RS1

VENDOR APPROVE			
Issued/Checked/Approved			
DATE: June. 6, 2023			

CUSTOMER APPROVE	
DATE:	

6/6/2023

THIN FILM CHIP RESISTORS UR05 SERIES

DESCRIPTION

The resistors are constructed in a high grade ceramic body (aluminum oxide). Internal metal electrodes are added at each end and connected by a resistive paste that is applied to the top surface of the substrate. The composition of the resistive layer is adjusted to give the approximate resistance required and the value is trimmed to nominated value within tolerance which controlled by laser trimming of this resistive layer. The resistive layer is covered with a protective coat. Finally, the two external end terminations are added. For environmental soldering issue, the outer layer of these end terminations is a Lead-free solder



MAIN FEATURE

- SMD metal film resistor
- High reliability and stability of 0.25% and below per customer request
- High performance of TCR: 50 & 25 ppm/C° and below per customer request
- Low current noise
- RoHS compliant and lead free

APPLICATION

- Medical equipment
- Measuring instrument
- Communication device
- Computer / Printer

RFQ

[Request For Quotation](#)

PART CODE GUIDE

CRUR	05	B	B	301R	S1
1	2	3	4	5	6

- 1) **CRUR**: Product code for Thin Film Chip Resistors
- 2) **05**: Size Code, 0805 (2012 Metric), UR05 Series, Dimension L2.00*W1.25*H0.50mm,
- 3) **B**: Resistance Range Tolerance Code, P: Jumper; B: +/-0.1%; D: +/-0.5%; F: +/-1%; J: +/-5%
- 4) **B**: Package Code, A: 4Kpcs/7" Reel; B:5kpcs/7" Reel; C:10kpcs/7" Reel; M:15kpcs/7" Reel; D:10kpcs/10" Reel; E:20kpcs/10" Reel
- 5) **301R**: Resistance value code. 0R: 0ohm; R5: 0.5ohm; 15R: 15ohm; 20R: 20ohm; 22R1: 22.1ohm; 51R: 51ohm; 100R: 100ohm; 301R: 301ohm; 1K:1Kohm; 1K1: 1.1Kohm; 2K: 2Kohm; 10K: 10Kohm; 10K5: 10.5Kohm; 12K: 12 Kohm; 150K: 150Kohm; 226K: 226Kohm; 1M: 1.0Mohm; 1M2: 1.2Mohm
- 6) **S1**: Internal control code, digits and letter; Blank: N/A

THIN FILM CHIP RESISTORS UR05 SERIES

DIMENSION (Unit: mm)

Image for reference

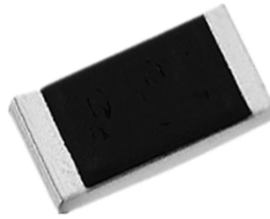

General Marking:

4-digits marking

*Each resistor is marked with a four digits code on the protective coating to designate the nominal resistance value

UR05 series

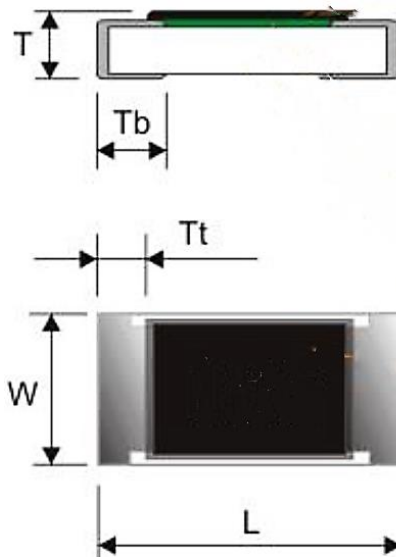

Item	Dimension
L	2.00±0.10
W	1.25±0.10
T	0.50±0.15
T b	0.40±0.20
T t	0.25±0.20

Resistors Construction For Reference

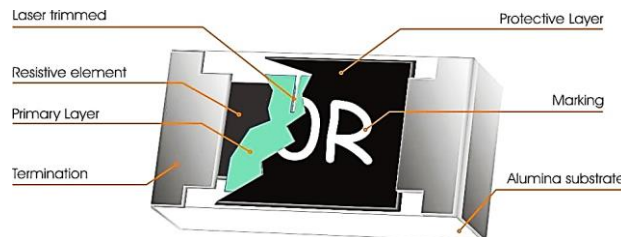

THIN FILM CHIP RESISTORS UR05 SERIES SERIES
GENERAL ELECTRONICAL CHARACTERISTICS

Item	Unit	Symbol	Characteristic	Condition
Product Name		CRUR	Thin Film Chip Resistors	
Size		05	UR05 Series, L2.00*W1.25*H0.50mm	
Resistance Range	Ω		301	
Resistance Tolerance	%	B	+/-0.1	
TCR	4.7Ω~2MΩ	ppm/°C	≤±25	
Max. Dissipation	W		1/10	@ Tamb=70°C
Operating Temperature	°C		-55 ~+155	
Max. Operation Voltage	V		100	@DC or RMS
Max. Overload Voltage	V		200	@DC or RMS

Note

- 1) This is the maximum voltage that may be continuously supplied to the resistor element, see "IEC publication 60115-8"
- 2) Max. Operation Voltage : So called RCWV (Rated Continuous Working Voltage) is determined by

$$RCWV = \sqrt{\text{Rated Power} \times \text{Resistance Value}} \text{ or Max. RCWV listed above, whichever is lower.}$$

THIN FILM CHIP RESISTORS UR05 SERIES

PRODUCT CHARACTERIZATION

Standard values of nominal resistance are taken from the E24 & E96 series for resistors with a tolerance of $\pm 0.1\%$, $\pm 0.5\%$, $\pm 1\%$ & $\pm 5\%$. The values of the E24/E96 series are in accordance with "IEC publication 60063"

DERATING

The power that the resistor can dissipate depends on the operating temperature; see Fig.1

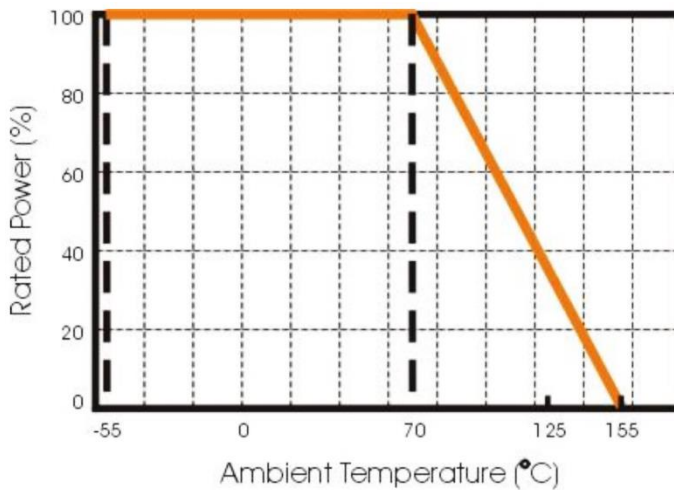

Fig 1 Maximum dissipation in percentage of rated power as a function of the ambient temperature for UR05

MOUNTING

Due to their rectangular shapes and small tolerances, Surface Mountable Resistors are suitable for handling by automatic placement systems. Chip placement can be on ceramic substrates and printed-circuit boards (PCBs). Electrical connection to the circuit is by individual soldering condition. The end terminations guarantee a reliable contact.

THIN FILM CHIP RESISTORS UR05 SERIES

REFLOW SOLDERING CONDITION

The robust construction of chip resistors allows them to be completely immersed in a solder bath of 260 °C for 10 seconds. Therefore, it is possible to mount Surface Mount Resistors on one side of a PCB and other discrete components on the reverse (mixed PCBs). Surface Mount Resistors are tested for solderability at 235 °C during 2 seconds. The test condition for no leaching is 260°C for 30 seconds. Typical examples of soldering processes that provide reliable joints without any damage are given in Fig 2.and Table 1.

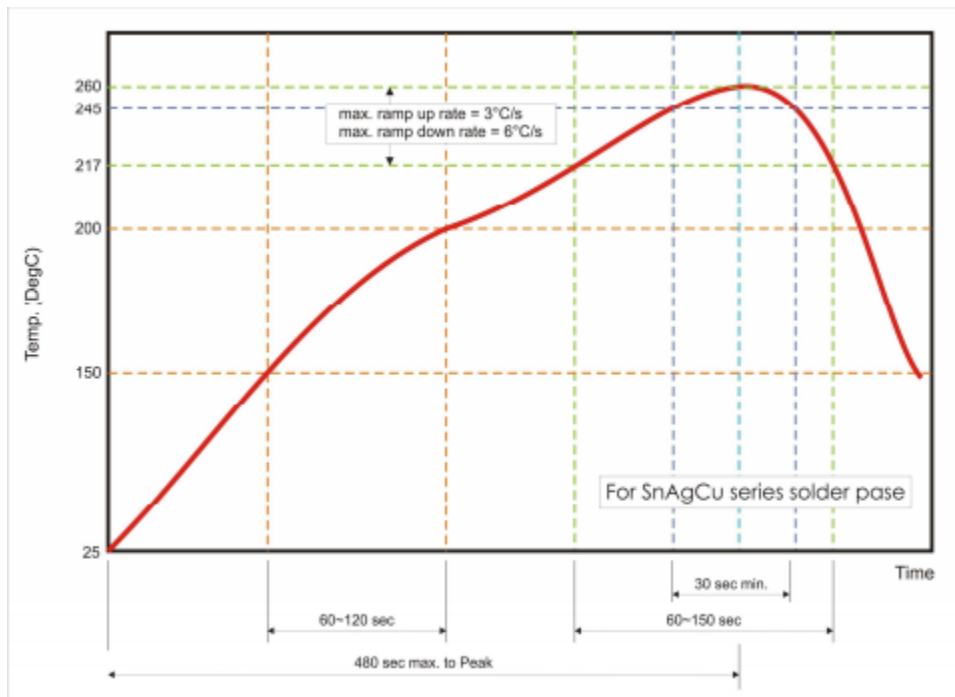

Fig 2. Infrared soldering profile for Chip Resistors

Table 1. Infrared soldering condition for Chip Resistors

Temperature Condition	Exposure Time
Average ramp-up rate (217°C to 260°C)	Less than 3°C/second
Between 150 and 200°C	Between 60- 120 seconds
> 217°C	Between 60- 150 seconds
Peak Temperature	260°C +0/-5°C
Time within 245°C	Min. 30 seconds
Ramp-down rate (Peak to 217°C)	Less than 6°C/second
Time from 25°C to Peak	No greater than 480 seconds

THIN FILM CHIP RESISTORS UR05 SERIES
TEST AND REQUIREMENT (JIS C 5201-1 : 1998)

TEST	PROCEDURE / TEST METHOD	REQUIREMENT
DC resistance Clause 4.5	DC resistance values measured	Within the specified tolerance
Temperature Coefficient of Resistance(T.C.R) Clause 4.8	Natural resistance change per change in degree centigrade. $\frac{R_2 - R_1}{R_1(t_2 - t_1)} \times 10^6 \text{ (ppm/}^\circ\text{C)}$ <p>t1 : 20°C+5°C-1°C R1 : Resistance at reference temperature R2: Resistance at test temperature t2 : 125°C+5°C-1°C</p>	Refer to "QUICK REFERENCE DATA"
Short time overload (S.T.O.L) Clause 4.13	Permanent resistance change after a 5second application of a voltage 2.5 times RCWV or the maximum overload voltage specified in the above list, whichever is less.	Δ R/R max. ±(0.1%+0.05Ω)
Resistance to soldering heat(R.S.H) IEC 60068-2- 58:2004	Un-mounted chips completely immersed for 10±1second in a SAC solder bath at 260 ±5°C	Δ R/R max.±(0.1%+0.05Ω) No visible damage
Solderability IEC 60068-2- 58:2004	Un-mounted chips completely immersed for 2±0.5second in a SAC solder bath at 235°C±5°C	Good tinning (>95% covered) No visible damage
Temperature cycling Clause 4.19	30 minutes at -55°C±3°C, 2~3 minutes at 20°C+5°C-1°C, 30 minutes at +155°C±3°C, 2~3 minutes at 20°C+5°C-1°C, total 5 continuous cycles	Δ R/R max. ±(0.25%+0.05Ω) No visible damage
Load Life (Endurance) Clause 4.25	70±2°C, 1000 hours, loaded with RCWV or Vmax, 1.5 hours on and 0.5 hours off	Δ R/R max. ±(0.25%+0.05Ω)
Humidity Clause 4.24	1000 hours, at rated continuous working voltage in humidity chamber controller at 40°C± 2°C and 90~95% relative humidity, 1.5hours on and 0.5 hours off	Δ R/R max. ±(0.25%+0.05Ω)
Bending strength Clause 4.33	Resistors mounted on a 90mm glass epoxy resin PCB(FR4); bending : 3 mm, once for 10 seconds.	Δ R/R max. ±(0.1%+0.05Ω)
Adhesion Clause 4.32	Pressurizing force: 5N, Test time: 10±1sec.	No remarkable damage or removal of the terminations.

6/6/2023

THIN FILM CHIP RESISTORS UR05 SERIES

REEL DIMENSION (Unit: mm)

7": 5,000Ppcs/Reel

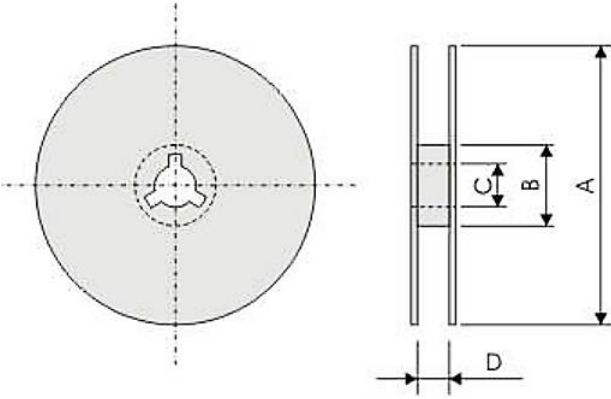

Code	Dimension 7"	Dimension 10"	Dimension 13"
A	178.0+/-2.0	254.0+/-2.0	330.0+/-2.0
B	60.0 +/--1.0	100 +/--1.0	100+/--1.0
C	13.0+/-0.20	13.0+/-0.20	13.0+/-0.20
D	9.0±0.5	9.0±0.5	9.0±0.5

TAPE DIMENSION (Unit: mm)

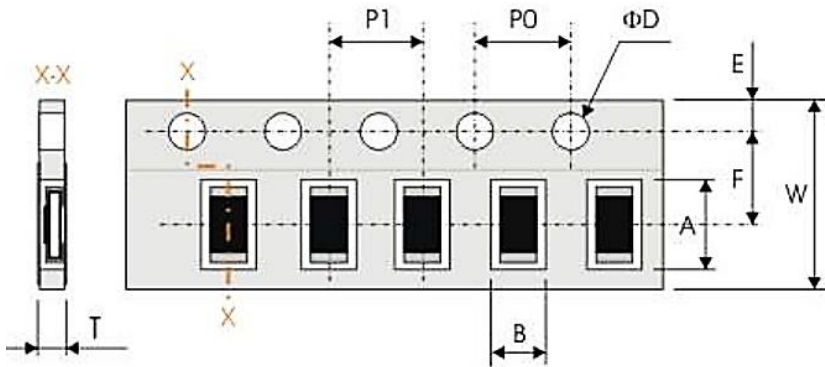

Code	Dimension
A	2.40±0.20
B	1.65±0.20
W	8.00±0.30
F	3.50±0.20
E	1.75±0.10
P 1	4.00±0.10
P0	4.00±0.10
ΦD	1.50±0.10/-0.0
T	1.0 Max.

TAPING QUANTITY AND TAPE MATERIAL

Tape	Paper Tape						Embossed Tape	Bulk Cassette
	4 mm Pitch			2 mm Pitch			4 mm Pitch	
Reel Size	7"	10"	13"	7"	10"	13"	7"	
UR05	5000				-	-	-	-

THIN FILM CHIP RESISTORS UR05 SERIES

PERFORMANCE OF TAPING

Strength of Carrier Tape and Top Cover Tape

Carrier Tape: When a tensile force 1.02kgf is applied in the direction of unreeling the tape, the tape shall withstand this force. Top cover Tape: When a tensile force 1.02kgf is applied to the tape, the tape shall withstand this force.

Peel Force of Top Cover Tape

Unless otherwise specified, the peel force of top cover tape shall be 10.2 to 71.4 g f when the top cover tape is pulled at a speed of 300mm/min with the angle between the taped during peel and the direction of unreeling maintained at 165 to 180° as illustrated in Fig.

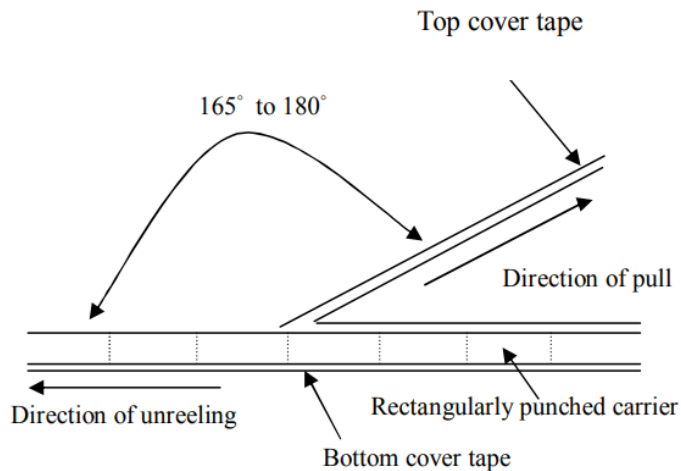

DISCLAIMER

NextGen Component, Inc. reserves the right to make changes to the product(s) and or information contained herein without notice. No liability is assumed as a result of their use or application. No rights under any patent accompany the sale of any such product(s) or information