



SPECIFICATION SHEET

SPECIFICATION SHEET NO.	Q0528-SBR318M000S022
DATE	May 28, 2023
REVISION	A0
DESCRIPTION	SMD SAW Resonator L3.8*W3.8*H1.50mm 3838 Type 6 Pads SBR Series 318.00000MHz, 1-Port, Insertion Loss: 1.8 dB Max. Tolerance ±75KHz Operating Temp. Range -40°C ~+85°C, Reflow Profile Condition 260 °C Max. Tape/Reel, 1000pcs/Reel RoHS/RoHS III compliant
CUSTOMER	
CUSTOMER PART NUMBER	
CROSS REF. PART NUMBER	
ORIGINAL PART NUMBER	TGS SBR 318.0MA TLF
PART CODE	SBR318M000S022

VENDOR APPROVE			
Issued/Checked/Approved			
DATE: May 28, 2023			

CUSTOMER APPROVE	
DATE:	

5/28/2023

SMD SAW RESONATOR 3838 TYPE SBR SERIES

MAIN FEATURE

- SMD SAW Resonator L3.8*W3.8*H1.50mm 3838 Type 6 Pads
- Package Code QCC6
- One Port SAW Resonator
- Electrostatic Sensitive Device(ESD)
- Low-loss and Short Lead time
- Cross more competitors part
- RoHS/RoHS III compliant



APPLICATION

- Bluetooth, wireless communication set
- Communication Electronics

RFQ

[Request For Quotation](#)

PART CODE GUIDE

SBR	318M000	S	022
1	2	3	4

- 1) SBR: Series Code, SMD SAW Resonator L3.8*W3.8*H1.50mm 3838 Type 6 Pads
- 2) 318M000: Frequency range code for 318.0000MHz
- 3) S: SMD type, Package Tape/Reel,
- 4) 022: Internal code (A~Z or 1~9 or Blank)

SMD SAW RESONATOR 3838 TYPE SBR SERIES

DIMENSION (Unit: mm, Tol.: +-0.15mm)

Image for reference

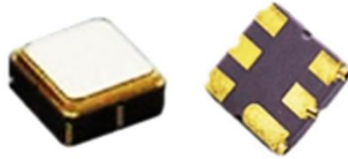

SDR series,
Package Code QCC6
L3.8*W3.8*H1.5mm
3838 Type

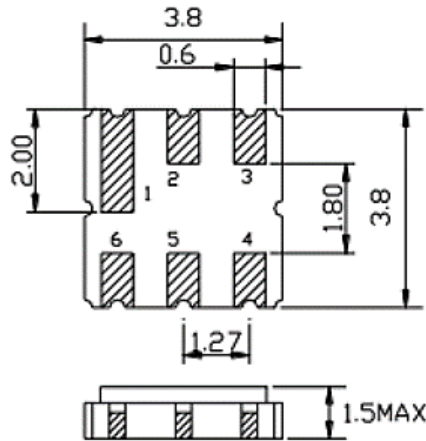

Pin	Configuration
2	Input
5	Output
1,3,4,6	Ground

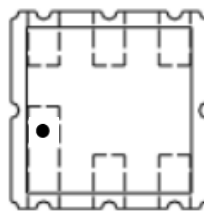

Marking:

Standard + ● : Pin 1

Test Circuit

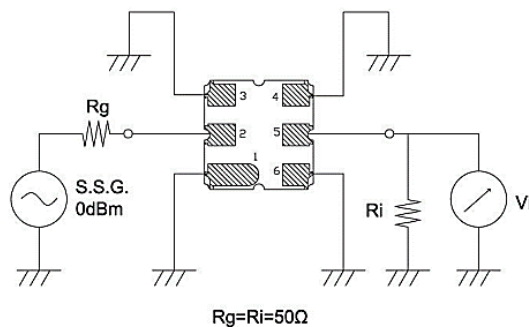

SMD SAW RESONATOR 3838 TYPE SBR SERIES
ELECTRICAL PARAMETERS

Parameter	Part No. Symbol	Units	Value		
			Min.	Typical	Max.
Original Manufacturer	TGS		TGS Crystals		
Holder Type	SBR		SMD SAW Resonator L3.8*W3.8*H1.5mm 3838 Type 6 Pads		
Frequency Range (f0)	318.0M	MHz	318.000		
Frequency Tolerance	A	KHz		±75	
Operation Temperature		°C	-40		+85
Storage Temperature		°C	-40		+85
DC Voltage		V		±30	
RF Power Dissipation		dBm		15	
Insertion Loss		dB		1.2	1.8
Quality Factor (Q) @Unload				16461	
Quality Factor (Q) @50 Ω Loaded				1777	
Turnover Temperature		°C			
Frequency Temp. Coefficient		ppm/°C			
Aging (Absolute Value during the First Year)		ppm/Year		≤±10	
DC Insulation Resistance		MΩ	1.0		
RF Equivalent RLC Model @Motional Resistance		Ω		12.0	22.0
RF Equivalent RLC Model @Motional Inductance		μH		99.7	
RF Equivalent RLC Model @Motional Capacitance		fF		2.61	
Static Capacitance		pF	3.4	3.7	4.0
Package		T		Tape/Reel	
RoHS Status	LF		RoHS III compliant		
Add Value			Blank: N/A		
Internal Control Code			Blank: N/A		

Note: 1) Test Temperature: 25°C±2°C, Terminating source impedance: 50Ω Terminating load impedance: 50Ω

2) Original Part Number: TGS SBR 318.0MA TLF

5/28/2023

4

SMD SAW RESONATOR 3838 TYPE SBR SERIES

FREQUENCY RESPONSE

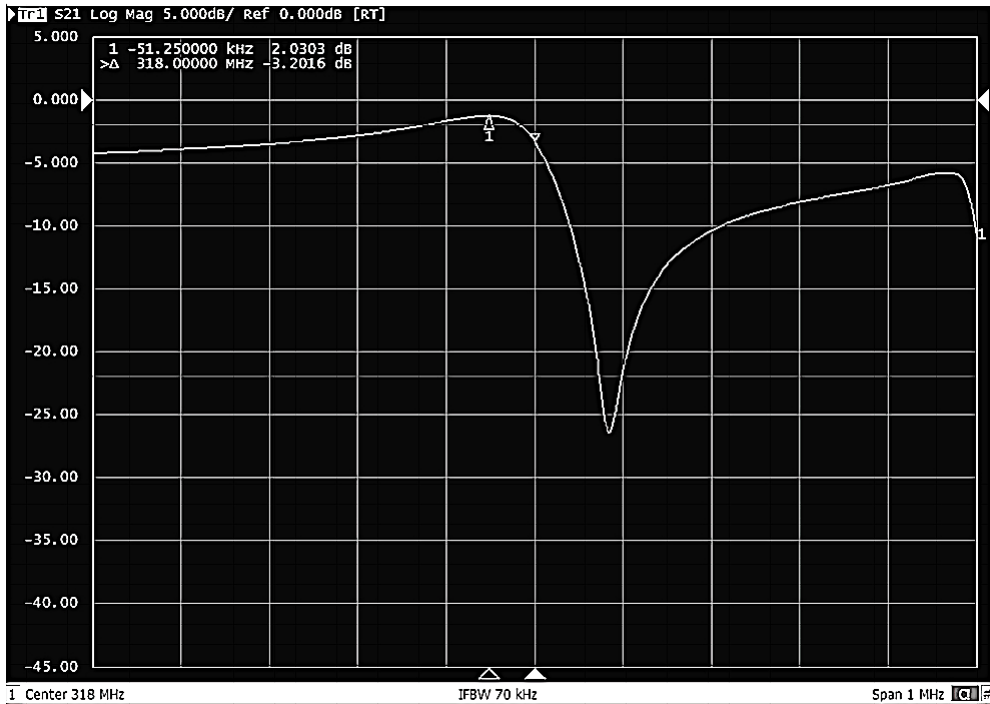

SMD SAW RESONATOR 3838 TYPE SBR SERIES

EQUIVALENT LC MODEL

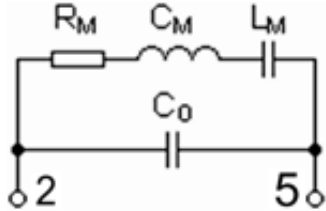

TEMPERATURE CHARACTERISTICS



Note: The curve shown above accounts for resonator contribution only and does not include LC component temperature contributions.

PLICTYPCIAL APATION CIRCUITS

Typical Low-power Transmitter Application



Typical Local Oscillator Application



SMD SAW RESONATOR 3838 TYPE SBR SERIES

RELIABILITY

Test Items	Test Method And Conditions	Requirement
Temperature Storage	(1) Temperature: 85°C±2°C , Duration: 250h , Recovery time: 2h±0.5h (2) Temperature: -40°C±3°C , Duration: 250h ,Recovery time: 2h±0.5h	It shall remain electrical performance after tests
Humidity Test	Conditions: 60°C±2°C , 90~95% RH Duration: 250h	
Thermal Shock	Heat cycle conditions: TA=-40°C±3°C, TB=85°C±2°C, t1=t2=30min, Switch time: ≤3min, Cycle time: 100 times, Recovery time: 2h±0.5h.	
Vibration Fatigue	Frequency of vibration: 10~55Hz Amplitude:1.5mm Directions: X,Y and Z Duration: 2h	
Drop Test	Cycle time: 10 times Height: 1.0m	
Solderability	Temperature: 245°C±5°C Duration: 3.0s--5.0s Depth: DIP--2/3 , SMD--1/5	
Resistance to Soldering Heat	(1)Thickness of PCB:1mm , Solder condition: 260°C±5°C , Duration: 10±1s (2)Temperature of Soldering Iron: 350°C±10°C , Duration: 3~4s , Recovery time : 2 ± 0.5h	

SMD SAW RESONATOR 3838 TYPE SBR SERIES

SUGGESTED REFLOW PROFILE (For Reference Only)



SMD SAW RESONATOR 3838 TYPE SBR SERIES

TAPE DIMENSION (Unit: mm, 1000pcs/Reel)

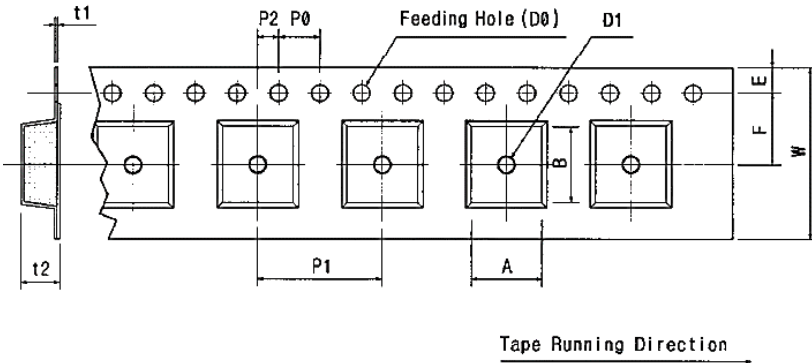

Code	Dimension
W	12.0+/-0.30
F	5.50+/-0.10
E	1.75+/-0.10
P 0	4.00+/-0.10
P 1	8.00+/-0.10
P 2	2.00+/-0.10
D 0	Ø1.5+/-0.10
D 1	Ø1.5+/-0.25
t 1	0.30+/-0.01
t 2	1.90+/-0.05
A	4.00+/-0.10
B	4.00+/-0.10

REEL DIMENSION (Unit: mm)

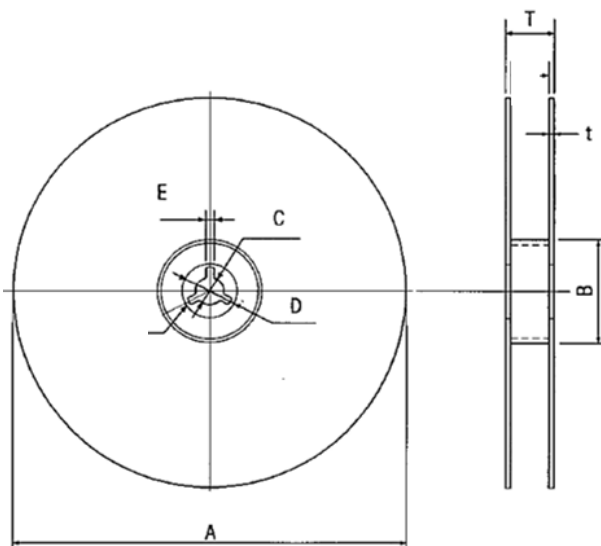

Code	Dimension
A	Ø178.0+/-2.0
B	Ø60.0+/-0.5
C	Ø13.0+/-0.5
D	Ø21+/-0.8
E	2.00+/-0.5
T	15.4+/-1.00
t	0.31 Max.

SMD SAW RESONATOR 3838 TYPE SBR SERIES

CAUTION

1. As a result of the particularity of inner structure of SAW products, it easy to be breakdown by electrostatic, so we should pay attention to ESD protect in the test.
2. Static voltage between signal load and ground may cause deterioration and destruction of the component. Please avoid static voltage.
3. Ultrasonic cleaning may cause deterioration and destruction of the component. Please avoid ultrasonic cleaning.
4. Only leads of component may be soldered. Please avoid soldering another part of component.
5. There is a close relationship between the device's performance and matching network. The specifications of this device are based on the test circuit shown above. L and C values may change depending on board layout. Values shown are intended as a guide only.
6. The temperature of manual welding should not exceed 300 °C.
7. The specifications of this device are based on the test circuit shown above and subject to change or obsolescence without notice.
8. All equipment designs utilizing this product must be approved by the appropriate government agency prior to manufacture or sale.
9. Our liability is only assumed for the Surface Acoustic Wave (SAW) component(s) perse, not for applications, processes and circuits implemented within components or assemblies.
10. For questions on technology, prices and delivery, please contact our sales offices or e-mail: sales@NextGenComponent.com.

DISCLAIMER

NextGen Components, Inc. reserves the right to make changes to the product(s) and or information contained herein without notice. No liability is assumed as a result of their use or application. No rights under any patent accompany the sale of any such product(s) or information

5/28/2023

10