

2JW0180z-C868B

5G NR/UHF Connector Mount

Key Features

5G NR/UHF

- 410-496 MHz
- 617-960 MHz
- 1427-2690 MHz
- 3300-5000 MHz
- 5150-5925 MHz

Connector Mount

Ultra Wide band Antenna

High Performance

Ground Plane Independent

Hinged Connector

Dimensions 171 × 38 × 13.8 mm



1. Antenna and electrical specifications

Parameters	5G NR Antenna				
Technologies	5G, 4G, 3G and 2G				
Standards	5G NR/4G LTE/FirstNet/CBRS/LPWA/CAT-X/CAT-Mx/CAT-NBx/NB-IoT/3G/2G/UHF				
Frequency (MHz)	410-496	617-960	1427-2690	3300-5000	5150-5925
Band (MHz)	450	600, 700, 850, 900	1500, 1600, 1700, 1800, 1900, 2000, 2100, 2300, 2500, 2600	3300, 3500, 3600, 3700, 4500	5200, 5500, 5800
5G NR Bands		n5, n8, n12, n20, n28, n71, n81, n82, n83,	n1, n2, n3, n7, n25, n34, n38, n39, n40, n41, n50, n51, n66, n70, n74, n75, n76, n80, n84, n86	n77, n78, n79	
4G LTE Bands	B31, B72, B73, B87, B88	B5, B6, B8, B12, B13, B14, B17, B18, B19, B20, B26, B27, B28, B29, B44, B67, B68, B71, B85	B1, B2, B3, B4, B7, B9, B10, B11, B21, B23, B24, B25, B30, B32, B33, B34, B35, B36, B37, B38, B39, B40, B41, B45, B50, B51, B65, B66, B69, B70, B74, B75, B76	B22, B42, B43, B48, B49, B52	B46, B47, B252, B255
3G CELL Bands		B5, B6, B8, B12, B13, B14, B19, B20, B26	B1, B2, B3, B4, B7, B9, B10, B11, B21, B25, B32, B33, B34, B35, B36, B37, B38, B39, B40	B22	
2G CELL Bands	410T, 450, 480	710, 750, 810T, 850, 900P, 900E, 900R	1800DCS, 1900PCS		
CDMA CELL Bands	BC5, BC11	BC0, BC2, BC3, BC7, BC9, BC10, BC12, BC18, BC19	BC1, BC4, BC6, BC8, BC13, BC14, BC15, BC16, BC20, BC21		
Return Loss (dB)	~-4.8	~-14.3	~-8.2	~-6.8	~-10.6
VSWR	~3.8:1	~1.7:1	~2.5:1	~4.1:1	~2.1:1
Efficiency (%)	~20.6	~40.8	~60.0	~40.8	~30.9
Peak Gain (dBi)	~-4.5	~0.5	~-2.1	~1.5	~-2.5
Average Gain (dB)	~-7.0	~-4.2	~-2.4	~-4.4	~-5.5
Impedance (Ohm)			50		
Polarisation			Linear		
Radiation Pattern			Omni-Directional		
Max. Input Power (W)			25		
Connector Type			SMA-Male		

Antenna Measurement Conditions:

Free Space

Measured in Certified CTIA 3D Anechoic Chamber

2. Mechanical and environmental specifications

Specifications	2JW0180z-C868B
Mounting Type	Connector Mount
Dimensions (mm)	171 × 38 × 13.8
Radome	PC/ABS UV Stable
Radome color	Black or White
Connector Feature	Hinged
Operating Temperature (C)	-40 to +85
Storage Temperature (C)	-40 to +85
Substance Compliance	RoHS, REACH

3. Antenna parameters

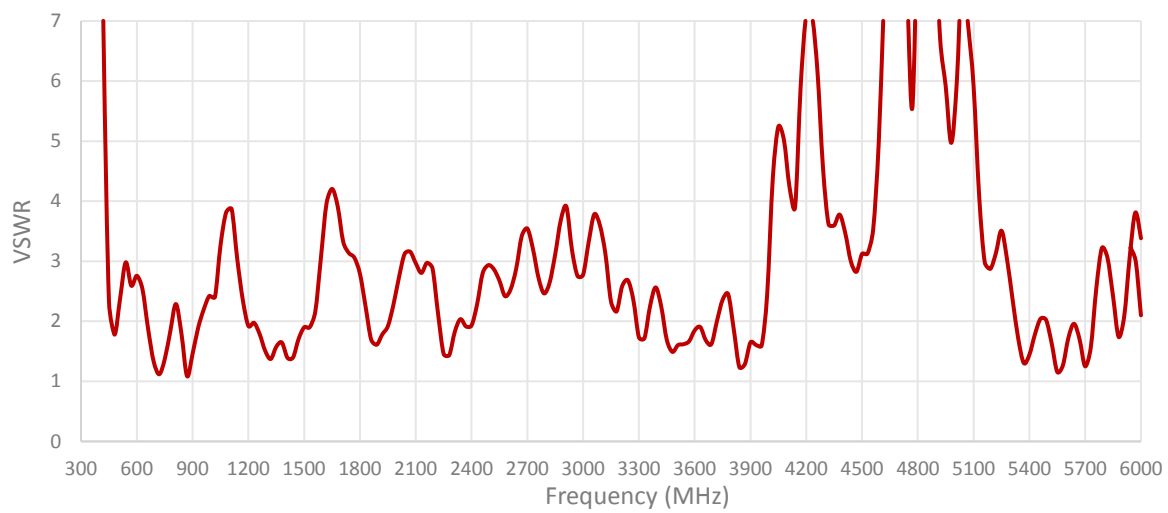
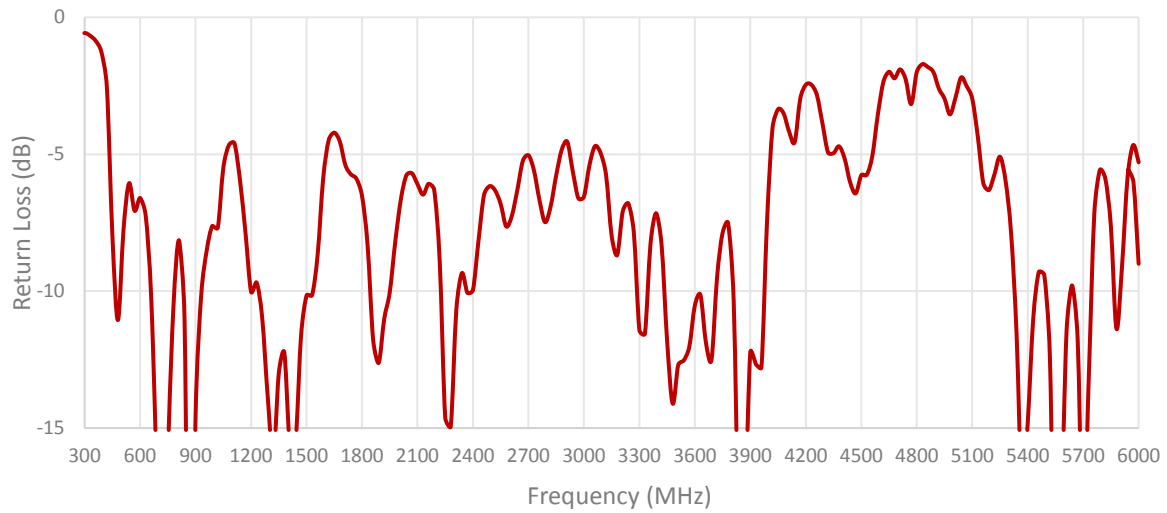

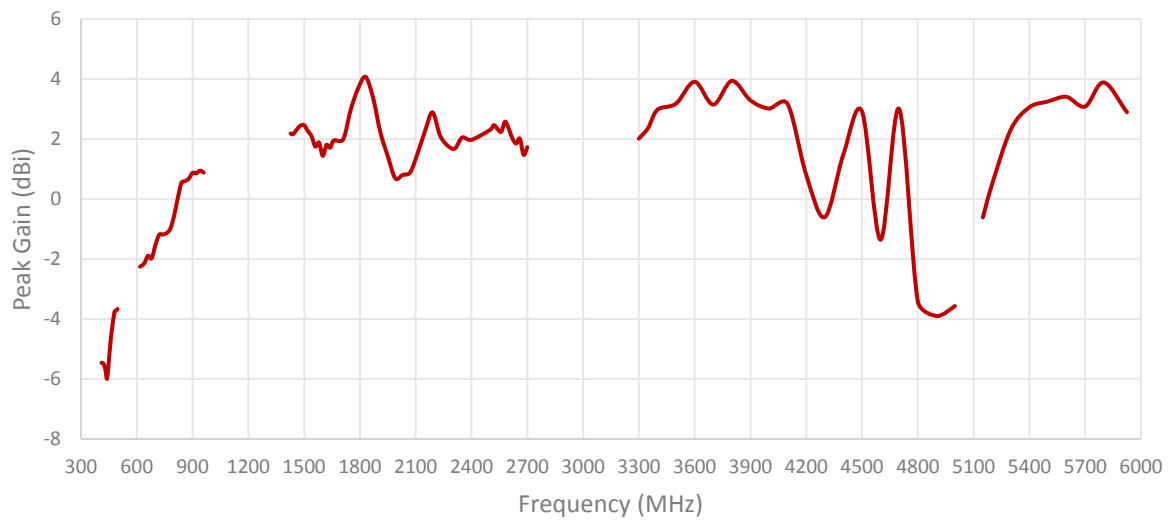
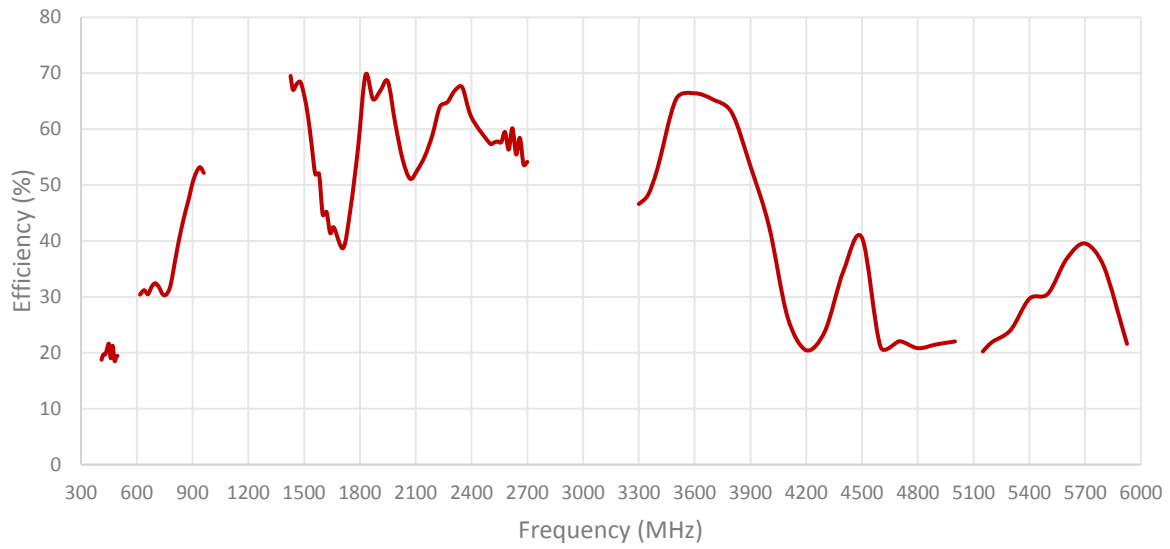

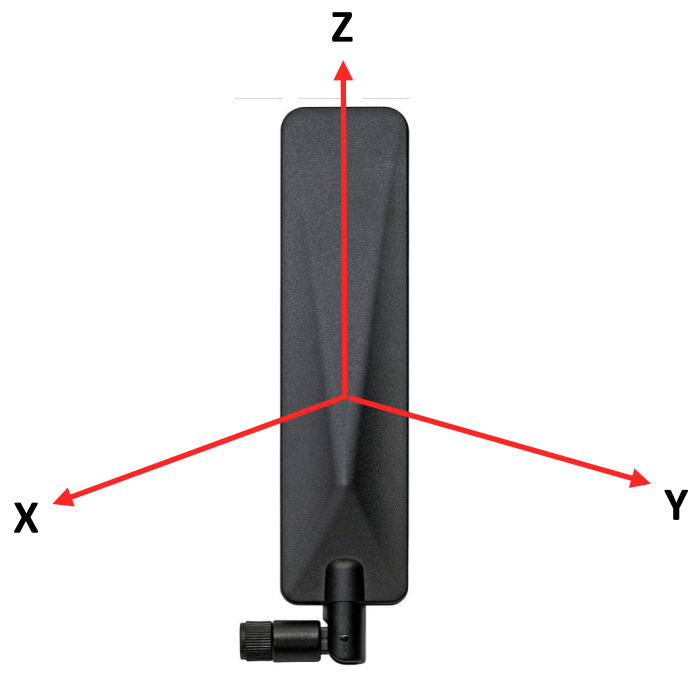
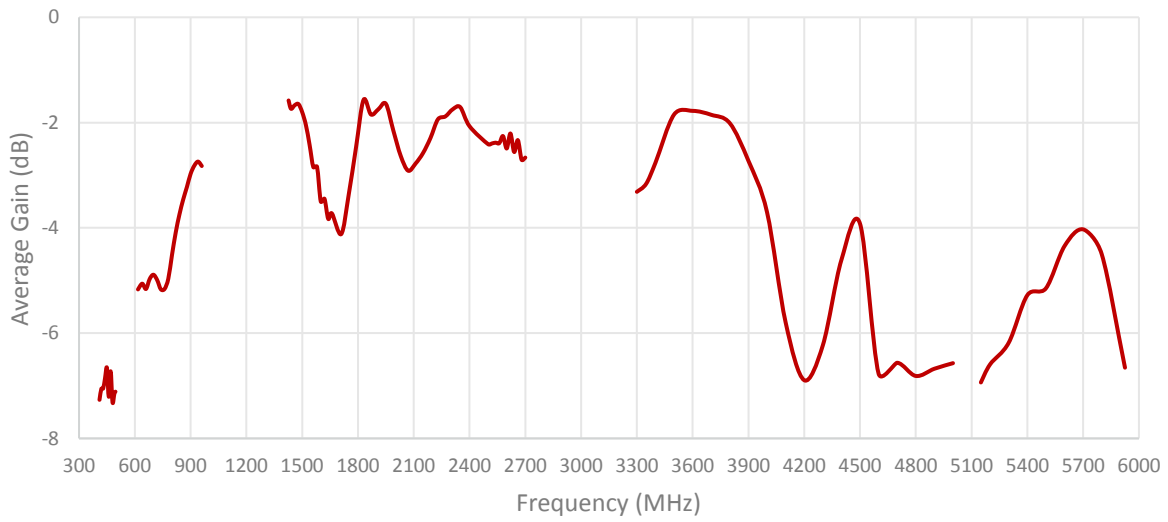

Radiation pattern reference

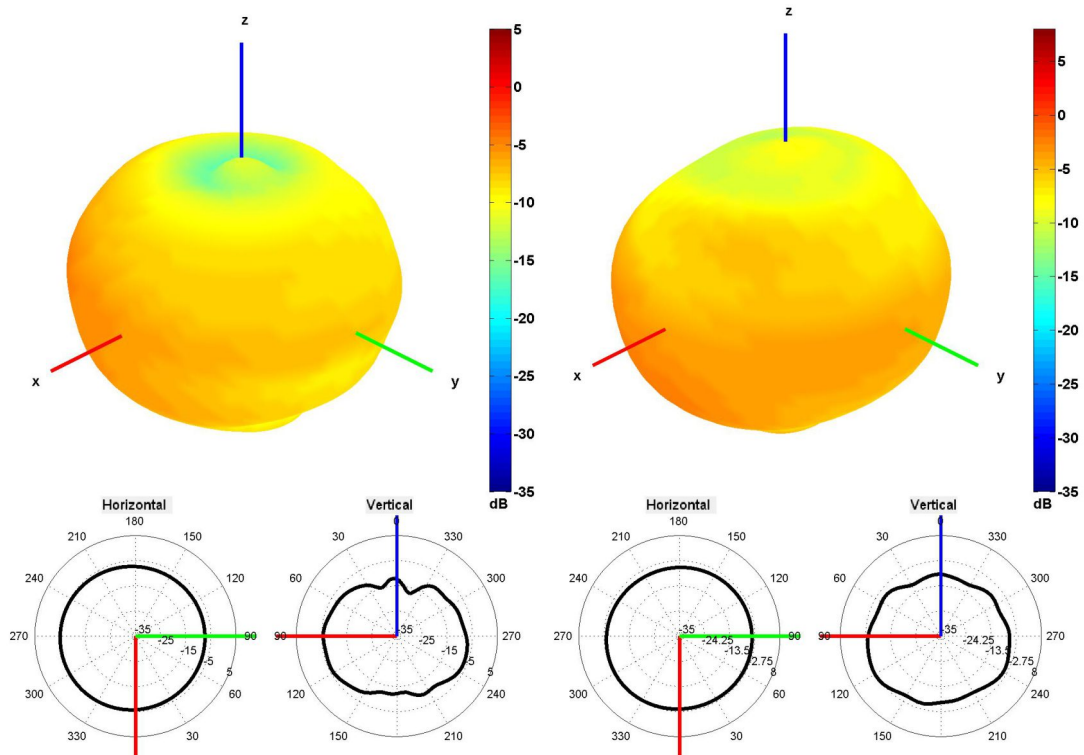

460 and 640 MHz Radiation pattern

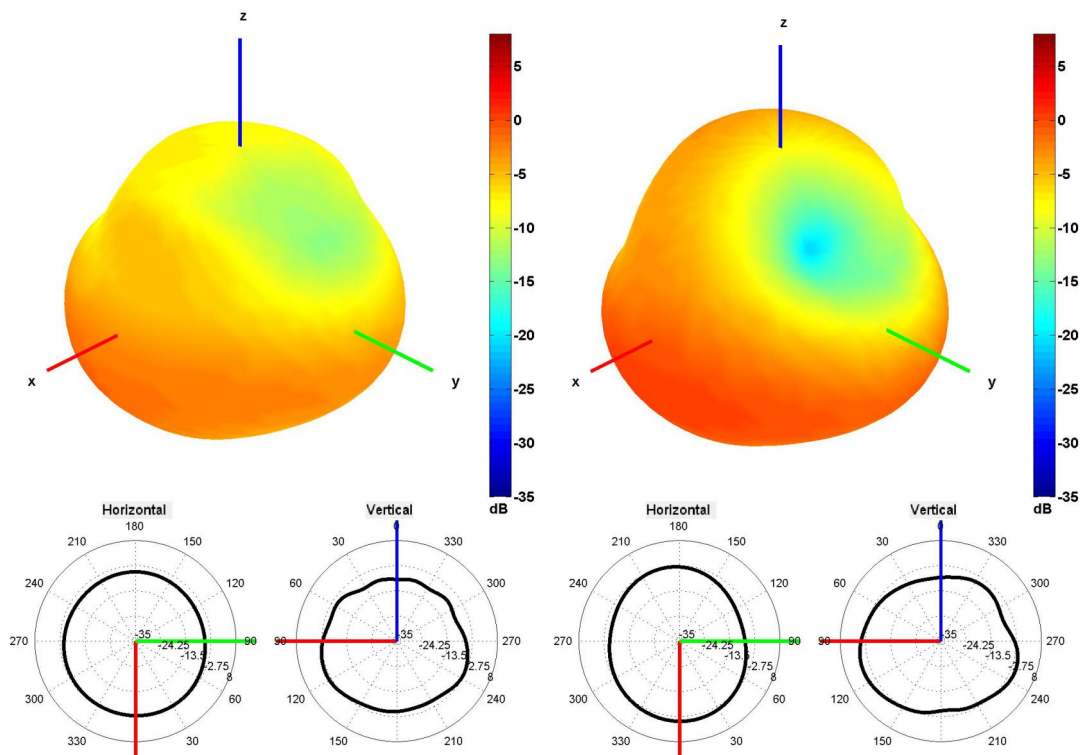

750 and 850 MHz Radiation pattern

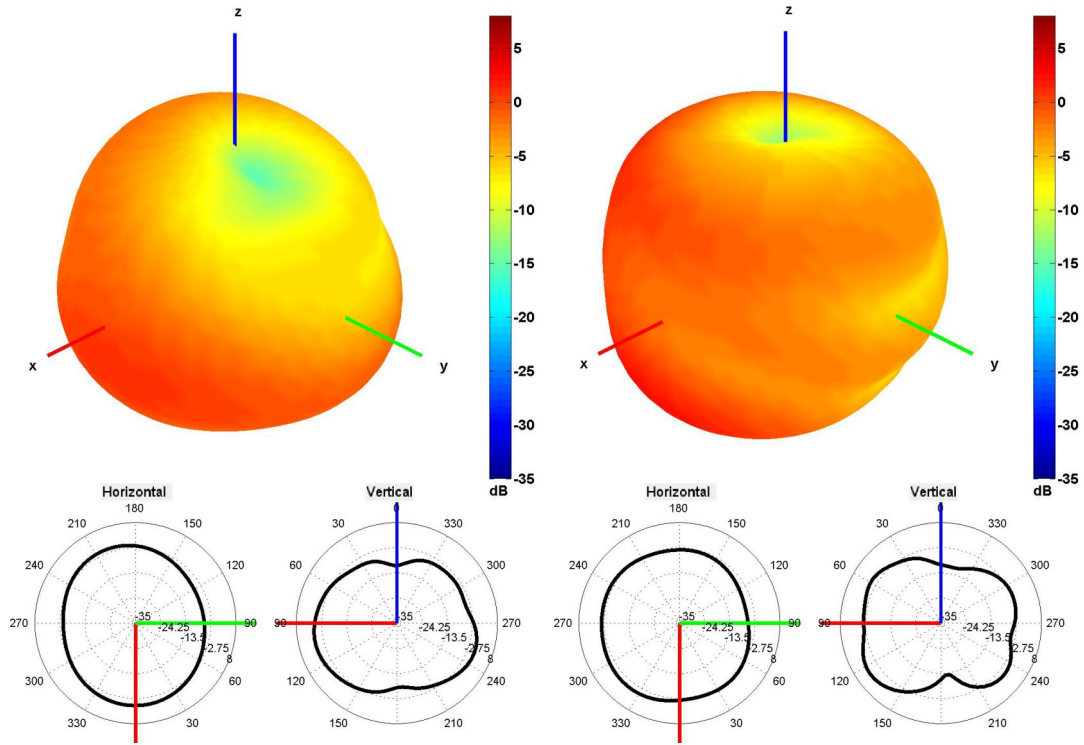

940 and 1500 MHz Radiation pattern

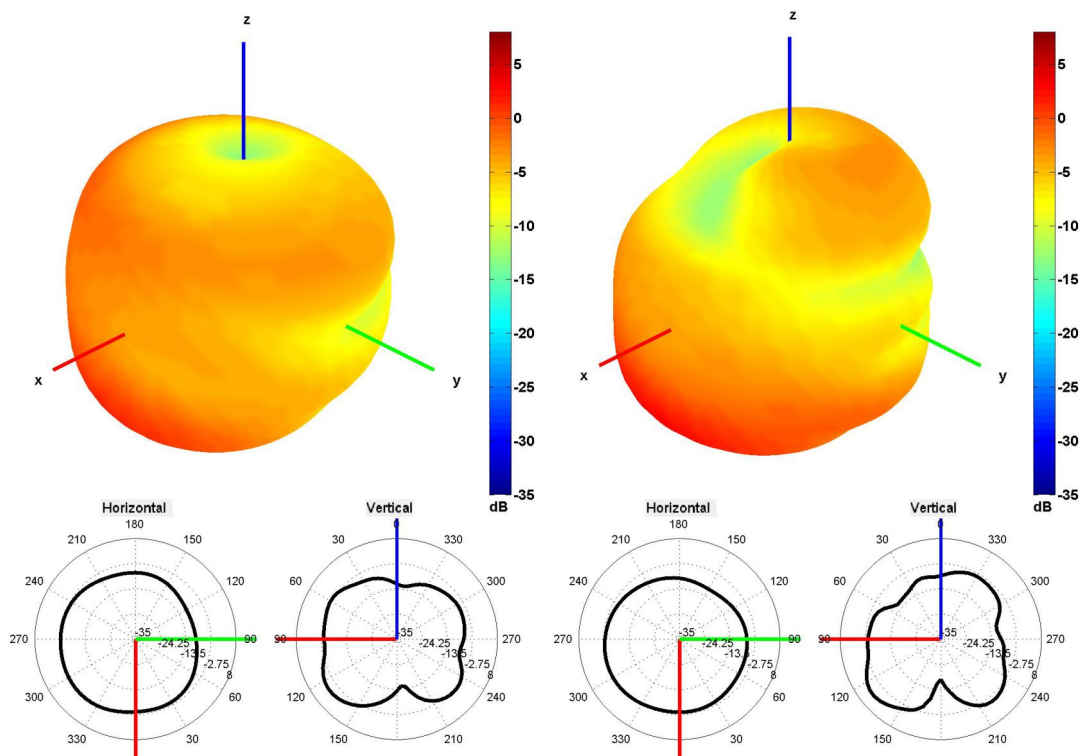

1600 and 1750 MHz Radiation pattern

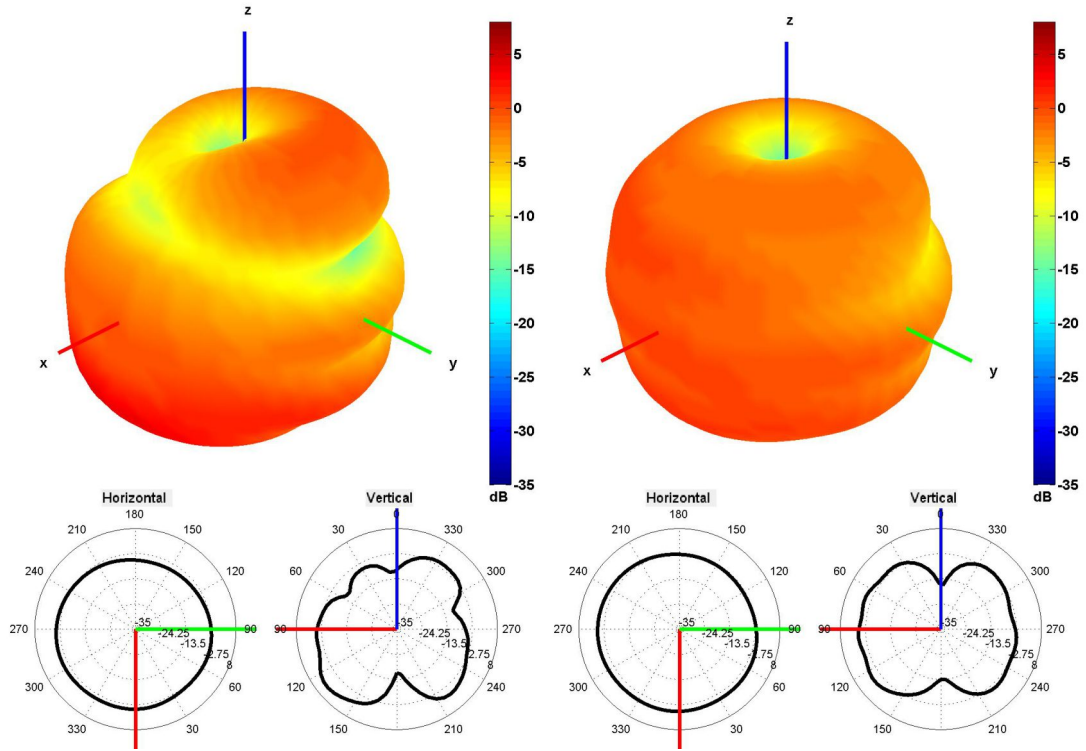

1850 and 1950 MHz Radiation pattern

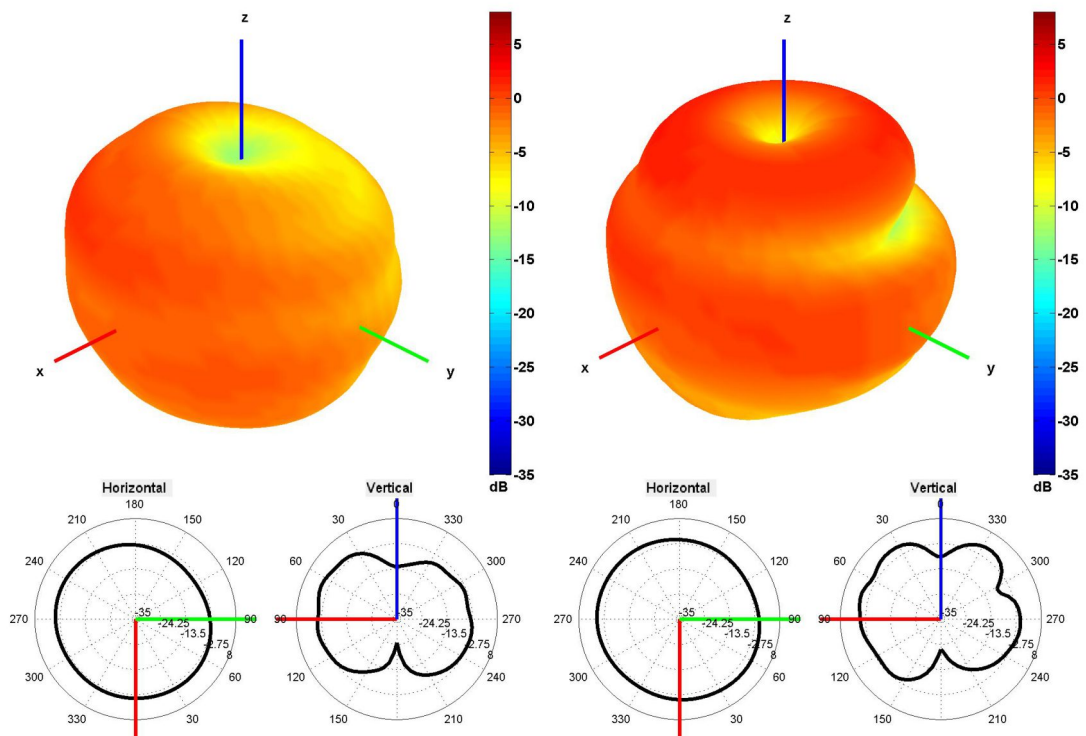

2360 and 2660 MHz Radiation pattern

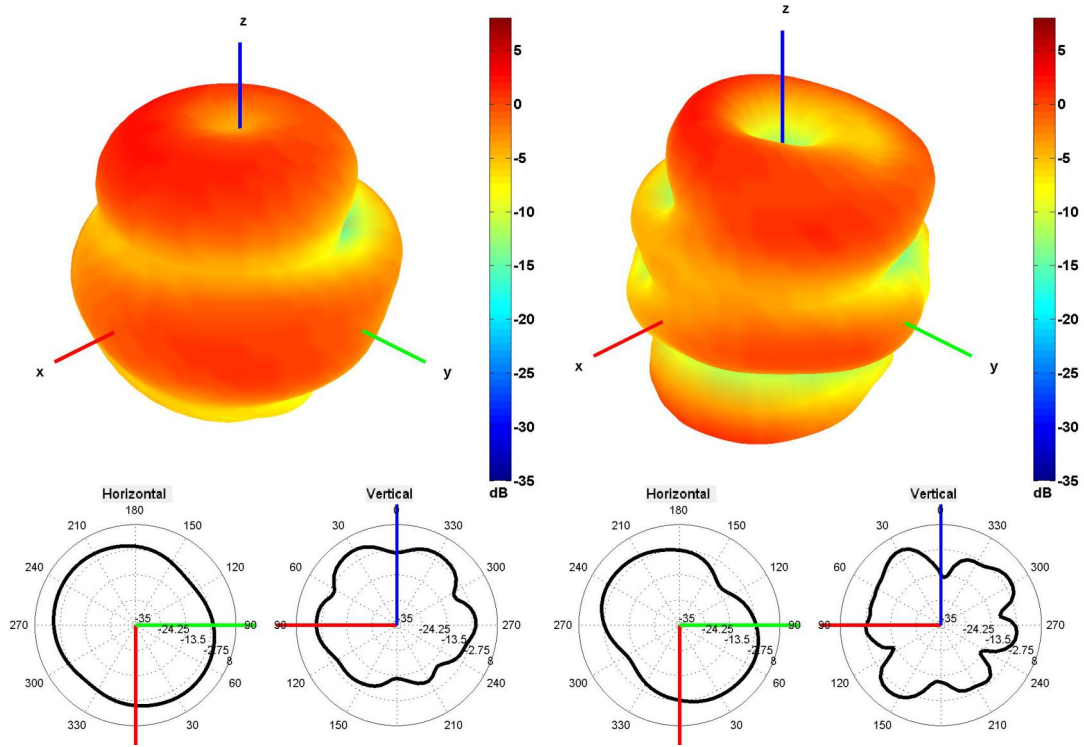

2600 and 3350 MHz Radiation pattern

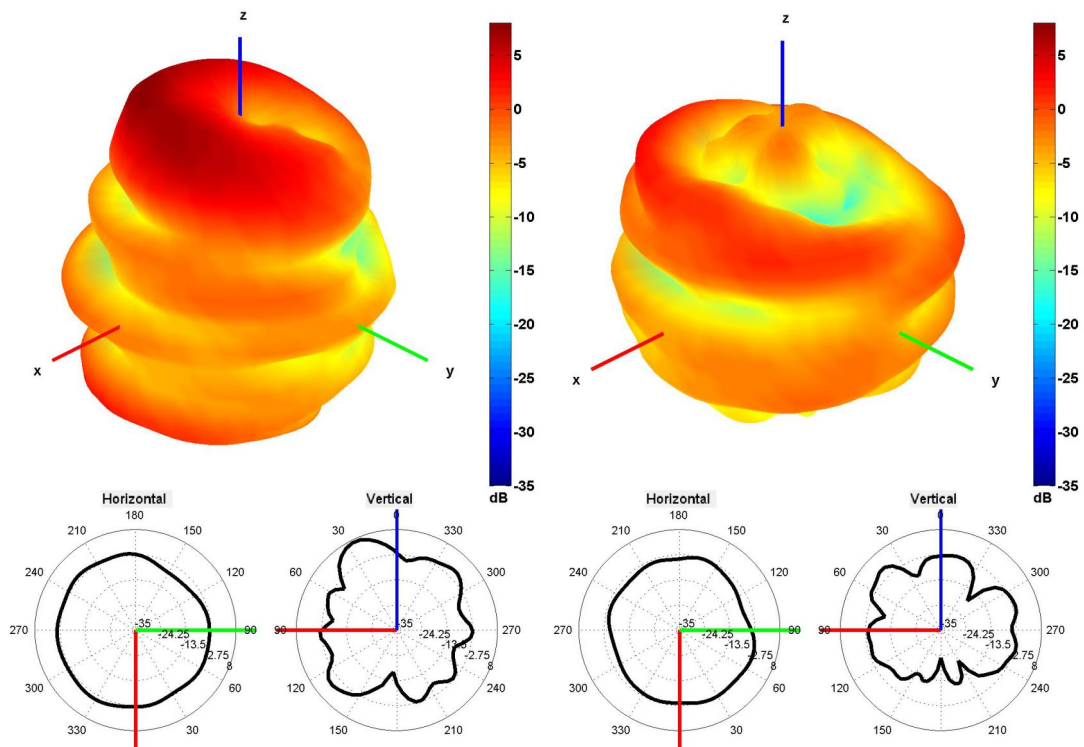

3600 and 4500 MHz Radiation pattern

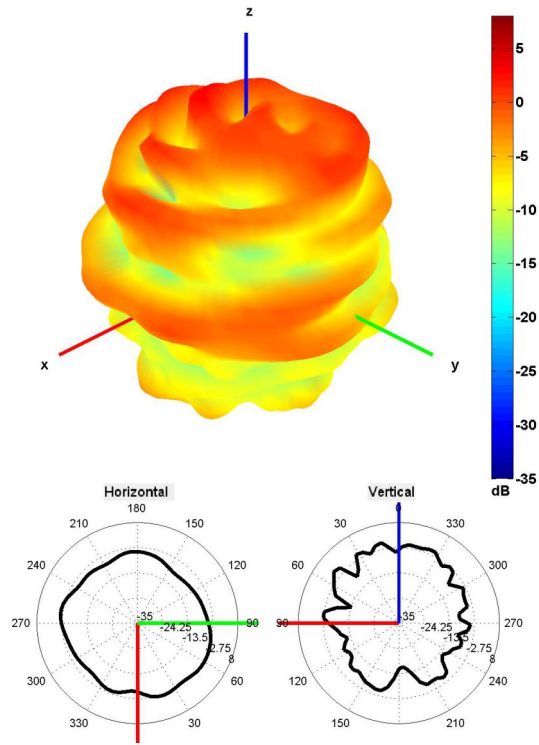

5500 MHz Radiation pattern

4. Antenna drawings

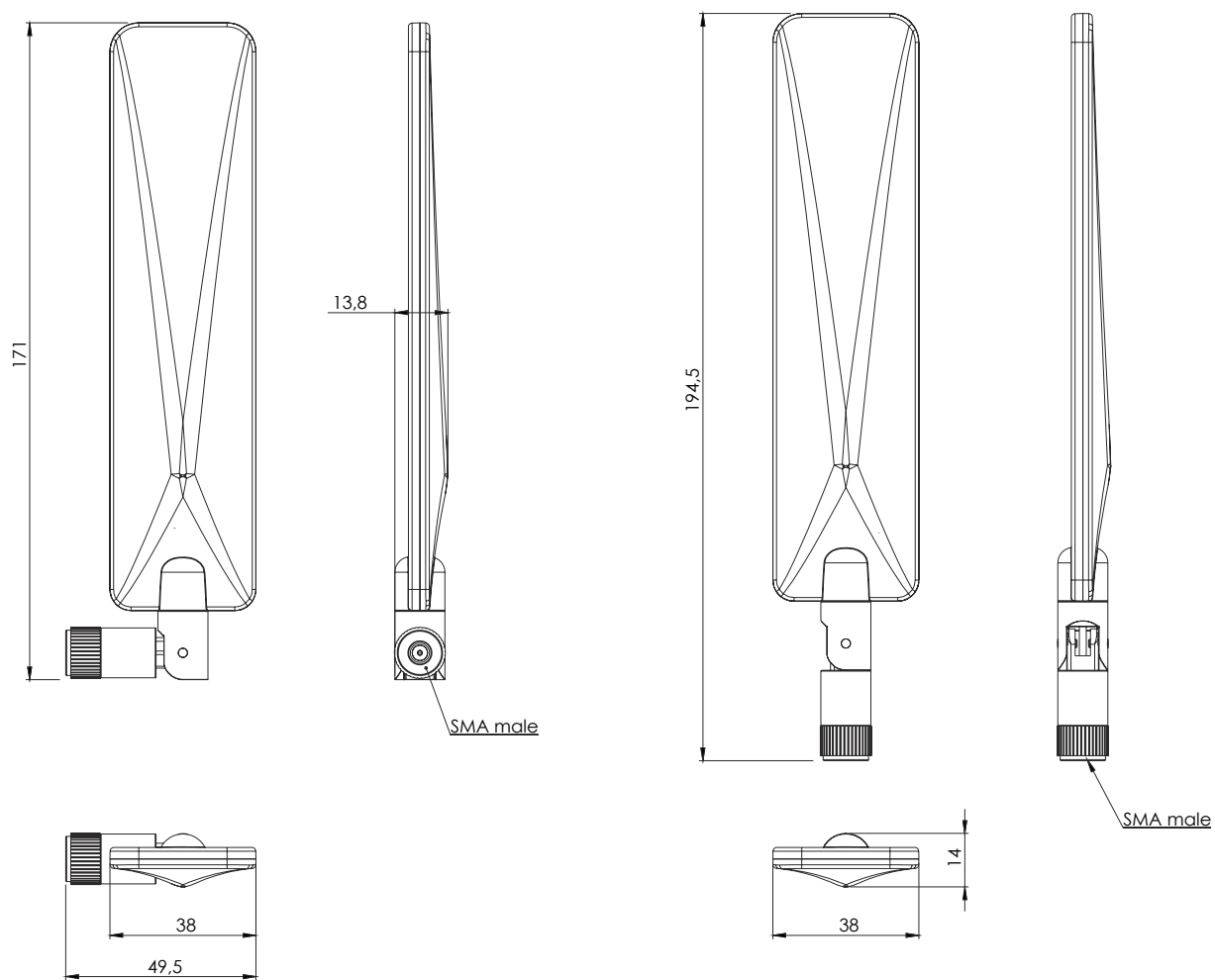

5. Antenna Images

