

**SPECIFICATION SHEET**

<b>SPECIFICATION SHEET NO.</b>	Q0201- XI40M00000S412
<b>DATE</b>	Feb. 01, 2023
<b>REVISION</b>	A0
<b>DESCRIPTION</b>	MHz SMD Crystal, Seam Seal, L2.5*W2.0*H0.55mm, 4 Pads, CM22 series 40.000MHz, Tolerance +/-10ppm, Load Capacitor 12pF, Frequency stability +/-30ppm @Operating Temp. Range -40°C ~+85°C, ESR 40 ohm Max, Reflow Profile Condition 260 °C Max. Tape/Reel, 3000pcs/Reel RoHS/RoHS III compliant
<b>CUSTOMER</b>	
<b>CUSTOMER PART NUMBER</b>	
<b>CROSS REF. PART NUMBER</b>	
<b>ORIGINAL PART NUMBER</b>	TGS CM22 40M0A10-12-30-40-40 TLF
<b>PART CODE</b>	XI40M00000S412

**VENDOR APPROVE**

Issued/Checked/Approved



DATE: Feb. 01, 2023

**CUSTOMER APPROVE**

DATE:

2/1/2023

**MHZ SMD CRYSTAL 2520 TYPE 4 PADS**

**MAIN FEATURE**

- Extra SMD Package, Seam Sealed Ceramic-Metal, 4pads
- 2520 Type, L2.5\*W2.0\*H0.55mm, 4 Pads,
- Low cost, High precision, High frequency stability
- Reflow Profile Condition 260 °C Max.
- Cross more competitors part
- RoHS/RoHS III compliant



**APPLICATION**

- Bluetooth, wireless communication set
- Communication Electronics

**PART CODE GUIDE**

**RFQ**

[Request For Quotation](#)

<b>XI</b>	<b>40M00000</b>	<b>S</b>	<b>412</b>
1	2	3	4

- 1) XI: Part family Code for SMD Crystal, 2520 Type, L2.5\*W2.0\*H0.55mm, 4 Pads, (CM22)
- 2) 40M00000: Frequency range code for 40.00000MHz
- 3) S: SMD type, Package Tape/Reel, 3000pcs/Reel
- 4) 412: Specification code for original part No.: **TGS CM22 40M0A10-12-30-40-40 TLF**

**MHZ SMD CRYSTAL 2520 TYPE 4 PADS**

**DIMENSION (Unit: mm, Tol. +/-0.15mm)**

Image for reference

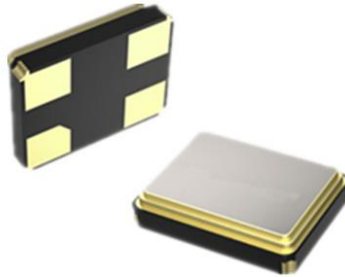

CM22

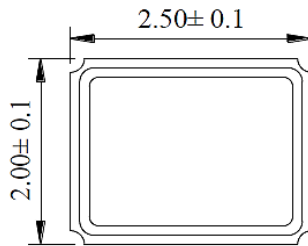

**Marking**  
standard

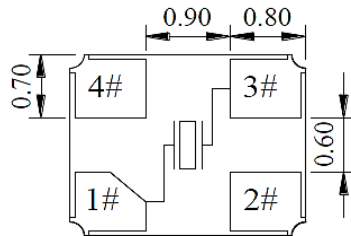

**Connection**  
#1 Crystal  
#2 Ground  
#3 Crystal  
#4 Ground

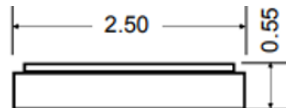

**Recommend Pad Layout**

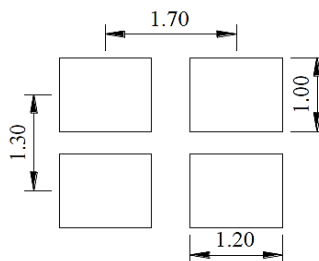

**MHZ SMD CRYSTAL 2520 TYPE 4 PADS**
**ELECTRICAL PARAMETERS**

Parameter	Part No. Symbol	Units	Value			Condition
			Min.	Typical	Max.	
Original Manufacturer	TGS	TGS Crystals				
Holder Type	CM22	SMD Crystal, 2520 Type, L2.5*W2.0*H0.55mm, 4 Pads				
Frequency Range	40M0	MHz	40.0000			
Mode of Oscillation	A	AT Fundamental				
Frequency Tolerance	10	ppm	-10		+10	@25°C
Load Capacitance	-12	pF	12			
Stability over Operation Temperature	-30	ppm	-30		+30	
Operation Temperature	-40	°C	-40		+85	
Storage Temperature		°C	-40		+85	
Equivalent Series Resistance (ESR)	-40	Ω			40	
Drive Level		μW			100	
Shunt Capacitance (C0)		pF	0		7.0	
Motional Capacitance (C1)		fF	N/A			
DLD2		Ω	N/A			
FLD2		ppm	N/A			
RDL2		Ω	N/A			
SPDB		dB	N/A			
Aging		ppm/year			±3	@1 <sup>st</sup> year
Insulation Resistance		MΩ	500			@100VDC ± 15VDC
Others	Package	T	Tape/Reel			
	RoHS Status	LF	RoHS III compliant			
	Add Value		N/A			
	Internal Control Code *		N/A			

Note: 1) Original Part Number: **TGS CM22 40M0A10-12-30-40-40 TLF**

2) \* Internal Control Code- 2 letter or digits; Blank: N/A

**MHZ SMD CRYSTAL 2520 TYPE 4 PADS**

**RELIABILITY**

Test Items	Test Method And Conditions	Reference Documents
<b>High Temperature High Humidity Storage</b>	Temperature: 85°C±3°C Relative Humidity:85%RH Time: 96 Hours	JIS C5023
<b>High Temperature Storage</b>	Temperature: 125°C±3°C Time: 96 Hours.	MIL-STD-883E Method 1005.8
<b>Low Temperature Storage</b>	Temperature: -40°C±3°C Time: 96 Hours.	MIL-STD-883E Method 1013
<b>Thermal Shock</b>	Temperature 1: -55°C±5°C Temperature 2: 85°C±5 °C Temperature change between T1 and T2 5 min 10cycles maintain T1 and T2 for 30 minutes each cycle	MIL-STD-202F Method 107 Condition A
<b>Resistance to Solder Heat</b>	Solder Temperature: 260°C±5°C Time: 10±1 Seconds	MIL-STD-202F Method 210E
<b>Solderability</b>	The solder pot temperature is 245±5°C , dwell time 5±0.5sec	J-STD-002B
<b>Drop Test</b>	3 Times Free Fall from 50cm height table to 3cm thickness hard wood board	J-STD-002B
<b>Mechanical Shock</b>	Half sine wave,1000 G 3 Times for all 3 directions(X,Y Z)	MIL STD 202F Method 213B
<b>Vibration</b>	Frequency Range: 10Hz ~ 55Hz Amplitude: 0.75mm 2 Hours in each direction, total 6 Hours	MIL-STD-883E Method 2007.3
<b>Leakage Test</b>	Take measurements with a helium Leakage detector Leakage Rate≤1×10 <sup>-3</sup> Pa cm <sup>3</sup> /s	MIL-STD-883E

**MHZ SMD CRYSTAL 2520 TYPE 4 PADS**

**SUGGESTED REFLOW PROFILE (For Reference Only)**

Total time: 200 Sec. Max. Solder melting point: 220°C



<b>Profile Feature</b>		Pb-Free Assembly
<b>Average Ramp-up Rate (Ts Max to Tp)</b>		3°C/second Max
<b>Preheat</b>	<b>Temperature Min (Ts Min.)</b>	125°C
	<b>Temperature Max (Ts Max.)</b>	200°C
	<b>Time (ts Min. to ts Max.)</b>	60 ~ 180 seconds
<b>Time maintained above</b>	<b>Temperature (Tl)</b>	217°C
	<b>Time (tl)</b>	60 ~ 150 seconds
<b>Peak/Classification Temperature (Tp)</b>		260 °C
<b>Time within 5°C of actual Peak Temperature (tp)</b>		20 ~ 40 seconds
<b>Ramp-down rate</b>		6 °C /Second Max.
<b>Time 25 °C to Peak Temperature</b>		8 minutes Max.
<b>Suggest reflow times</b>		3 Times Max.

**MHZ SMD CRYSTAL 2520 TYPE 4 PADS**

**TAPE/REEL (Unit: mm)**

All Devices are packed in accordance with EIA standard RS-481-2 and specifications, 3000pcs/Reel

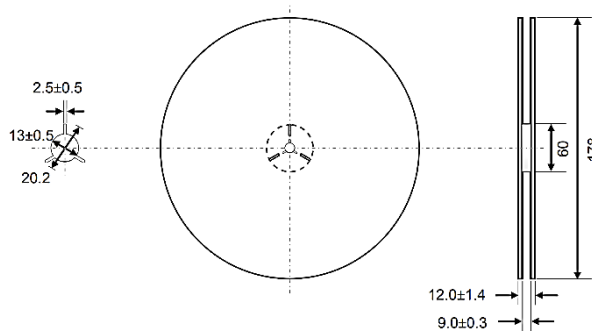
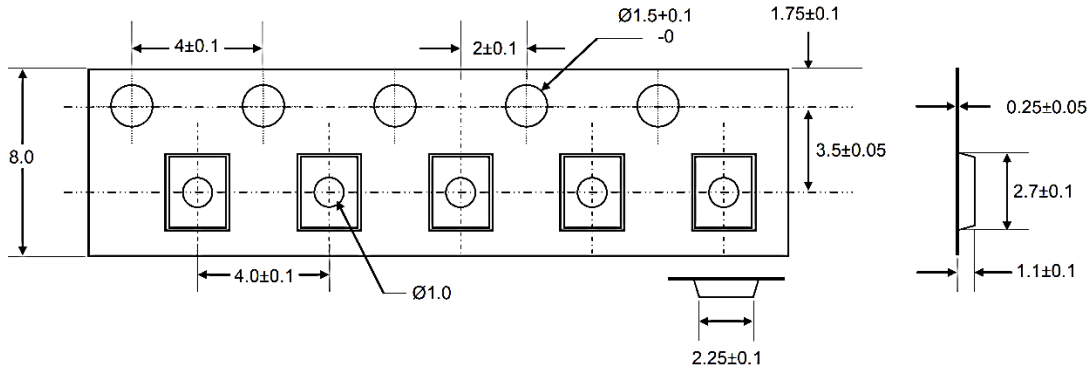

**DISCLAIMER**

NextGen Components, Inc. reserves the right to make changes to the product(s) and or information contained herein without notice. No liability is assumed as a result of their use or application. No rights under any patent accompany the sale of any such product(s) or information

2/1/2023