



**SPECIFICATION SHEET**

<b>SPECIFICATION SHEET NO.</b>	R0412- CRCR12FA3R3S01	
<b>DATE</b>	Apr. 12, 2024	
<b>REVISION</b>	A1	Updated With Most Recent Data
<b>DESCRIPTION AND MAIN PARAMETRICS</b>	<p>Thick Film Chip Resistors, 2512 (6432 Metric), CR12 Series,            Dimension L6.40*W3.20*H0.60mm, 2 Terminations,            Tolerance: <math>\pm 1.0\%</math>, Resistance 3.3 ohm, Dissipation Max. 1W @ 70°C,            Temperature Coefficient Rate (TCR) Max. <math>\pm 200\text{ppm}/^\circ\text{C}</math>            Operating Temp. Range <math>-55^\circ\text{C} \sim +155^\circ\text{C}</math>            Package in Tape/Reel, 4,000pcs/Reel            RoHS/RoHS III compliant and HF</p>	
<b>CUSTOMER</b>		
<b>CUSTOMER PART NO.</b>		
<b>CROSS REF. PART NO.</b>		
<b>ORIGINAL MFG/PART NO.</b>	Aillen/CR12FA3R3	
<b>PART CODE</b>	CRCR12FA3R3S01	

<b>VENDOR APPROVE</b>			
Issued/Checked/Approved			
DATE: Apr. 12, 2024			

<b>CUSTOMER APPROVE</b>	
DATE:	

4/12/2024

## THICK FILM CHIP RESISTORS CR12 SERIES

### DESCRIPTION

The resistors are constructed in a high grade ceramic body (aluminum oxide). Internal metal electrodes are added at each end and connected by a resistive paste that is applied to the top surface of the substrate. The composition of the paste is adjusted to give the approximate resistance required and the value is trimmed to within tolerance by laser cutting of this resistive layer. The resistive layer is covered with a protective coat. Finally, the two external end terminations are added. For ease of soldering the outer layer of these end terminations is a Tin (lead free) alloy.

### MAIN FEATURE

- High power rating and compact size
- High reliability and stability
- Reduced size of final equipment
- RoHS compliant and Lead free products



### APPLICATION

- Power supply / PDA
- Digital meter / PC
- Automotives / Battery charger
- DC-DC power converter

### HOW TO ORDER

- Please indicate pat code OR custom parameters code and send us your RFQ by E-mail

**THICK FILM CHIP RESISTORS CR12 SERIES**

**PART CODE GUIDE**

**RFQ**

[Request For Quotation](#)

CODE	NAME	KEY SPECIFICATION OPTION
CRCR	Product code	Thick Film Chip Resistors
12	Size Code	2512 (6432): L6.40*W3.20mm*H0.60mm
F	Resistance Range  Tolerance Code	P: Jumper; B: +/-0.1%; D: +/-0.5%; F: +/-1%; J: +/-5%
A	Package Code	A: 4Kpcs/7" Reel; B:5kpcs/7" Reel; C:10kpcs/7" Reel; M:15kpcs/7" Reel;  D:10kpcs/10" Reel; E:20kpcs/10" Reel
3R3	Resistance value  code	0R: 0ohm; 3R3: 3.3ohm; 12R: 12ohm; 20R: 20ohm; 51R: 51ohm;  240R: 240ohm; 390R: 390ohm; 1K:1Kohm; 2K: 2Kohm; 3K9: 3.9Kohm; 13K7:  13.7Kohm; 62K: 62Kohm; 100K: 100Kohm; 118K: 118Kohm;  1M: 1.0Mohm; 2M: 2Mohm
S01	Internal control  code,	Custom letter A~Z, a-z or digits (0-9)

**THICK FILM CHIP RESISTORS CR12 SERIES**

**DIMENSION (Unit: mm)**

Image for reference



**General Marking:**  
Blank

CR12 series

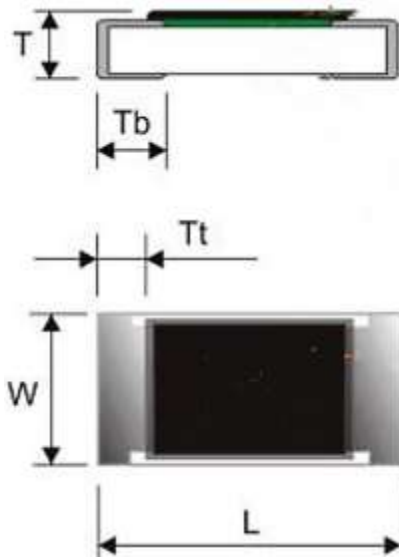

Item	Dimension
L	6.40±0.20
W	3.20±0.20
T	0.60±0.10
T b	0.90±0.25
T t	0.65±0.25

**Resistors Construction For Reference**

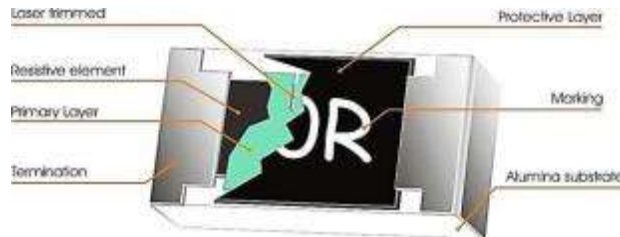

**Recommended Solder Pad**

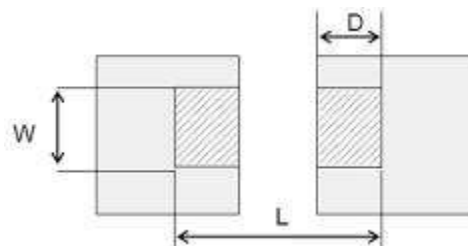

Item	Dimension
W	3.6~4.0
L	7.8~8.6
D	2.3~3.5

**THICK FILM CHIP RESISTORS CR12 SERIES**
**GENERAL ELECTRICAL CHARACTERISTICS**

Item	Unit	Symbol	Characteristic	Condition
Product Name		CRCR	Thick Film Chip Resistors	
Size		12	CR12 Series, L6.40*W3.20*H0.60mm	
Resistance Range	Ω		3.3	
Resistance Tolerance	%	F	+/-1	
TCR	10Ω ≤ Rn ≤ 10M Ω	ppm/°C	≤±100	
	1Ω ≤ Rn ≤ 10 Ω		≤±200	
Max. Dissipation	W		1	@Tamb=70°C
Operating Temperature	°C		-55 ~+155	
Max. Operation Voltage	V		250	@DC or RMS
Max. Overload Voltage	V		500	@DC or RMS

**Note**

1. This is the maximum voltage that may be continuously supplied to the resistor element, see "IEC publication 60115-8"
2. Max. Operation Voltage : So called RCWV (Rated Continuous Working Voltage) is determined by  $RCWV = \sqrt{\text{Rated Power} \times \text{Resistance Value}}$  or Max. RCWV listed above, whichever is lower.
3. Max. Operation Current : So called RCWC (Rated Continuous Working Current) is determined by
4.  $RCWC = \sqrt{\text{Rated Power} / \text{Resistance Value}}$

Item	Unit	Symbol	Characteristic	Condition
Power Rating At 70°C	W		1	
Max. Resistance	mΩ		50	
Rated Current	A		4.5	
Peak Current	A		11	
Operating Temperature	°C		-55 ~+155	

**THICK FILM CHIP RESISTORS CR12 SERIES**

**PRODUCT CHARACTERIZATION**

Standard values of nominal resistance are taken from the E24 & E96 series for resistors with a tolerance of +/-0.1%, +/-0.5%, +/-1% & +/-5%, The values of the E24/E96 series are in accordance with "IEC publication 60063"

**DERATING**

The power that the resistor can dissipate depends on the operating temperature; see Fig.1

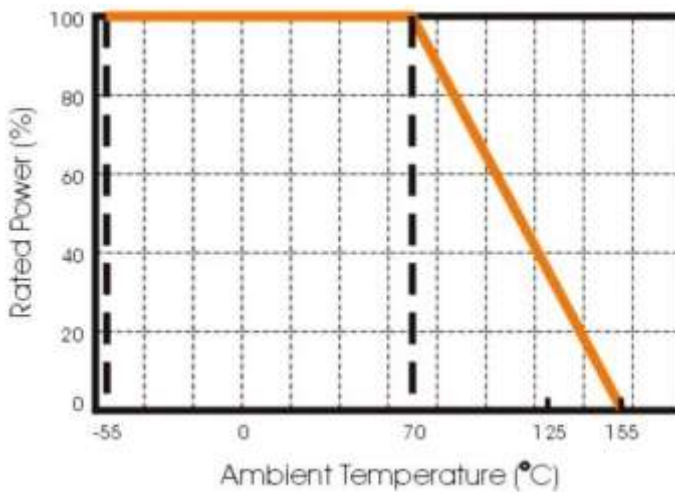

Fig 1 Maximum dissipation in percentage of rated power as a function of the ambient temperature for CR12

## THICK FILM CHIP RESISTORS CR12 SERIES

### REFLOW SOLDERING CONDITION

The robust construction of chip resistors allows them to be completely immersed in a solder bath of 260 °C for 10 seconds. Therefore, it is possible to mount Surface Mount Resistors on one side of a PCB and other discrete components on the reverse (mixed PCBs). Surface Mount Resistors are tested for solderability at 235 °C during 2 seconds. The test condition for no leaching is 260°C for 30 seconds. Typical examples of soldering processes that provide reliable joints without any damage are given in below.

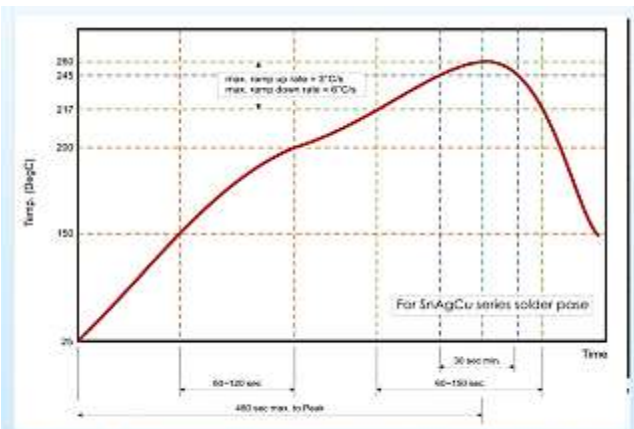

Fig. 1 Recommended IR reflow soldering profile for SMT process with SnAgCu series solder paste.

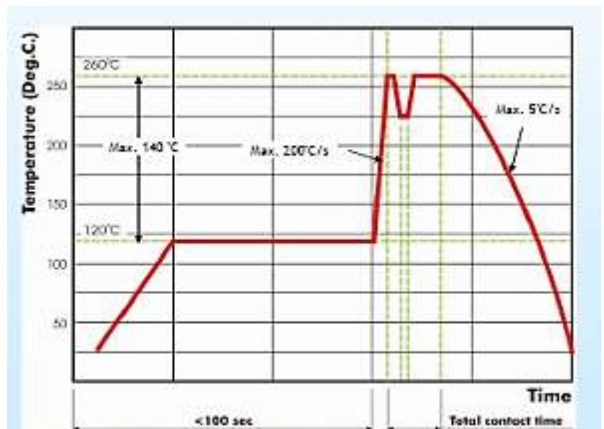

Fig. 2 Recommended wave soldering profile for SMT process with SnAgCu series solder.

**THICK FILM CHIP RESISTORS CR12 SERIES**
**TEST AND REQUIREMENT (JIS C 5201-1 : 1998)**

TEST	PROCEDURE / TEST METHOD	REQUIREMENT
DC resistance Clause 4.5	DC resistance values measured at the test voltages specified below : <10Ω@0.1V, <100Ω@0.3V, <1KΩ@1.0V, <10KΩ@3V, <100KΩ@10V, <1MΩ@25V, <10MΩ@30V	Within the specified tolerance
Temperature Coefficient of Resistance(T.C.R) Clause 4.8	Natural resistance change per change in degree centigrade. $\frac{R_2 - R_1}{R_1(t_2 - t_1)} \times 10^6 \text{ (ppm/}^\circ\text{C)}$ t1 : 20°C+5°C-1°C R1 : Resistance at reference temperature R2: Resistance at test temperature	Refer to “QUICK REFERENCE DATA”
Short time overload (S.T.O.L) Clause 4.13	Permanent resistance change after a 5second application of a voltage 2.5 times RCWV or the maximum overload voltage specified in the above list, whichever is less.	Δ R/R max. ±(2%+0.1Ω )
Resistance to soldering heat(R.S.H) Clause 4.18	Un-mounted chips completely immersed for 10±1second in a SAC solder bath at 260 ±5°C	Δ R/R max.±(1%+0.05Ω ) No visible damage
Solderability Clause 4.17	Un-mounted chips completely immersed for 2±0.5second in a SAC solder bath at 235°C±5°C	Good tinning (>95% covered) No visible damage
Temperature cycling Clause 4.19	30 minutes at -55°C±3°C, 2~3 minutes at 20°C+5°C-1°C, 30 minutes at +155°C±3°C, 2~3 minutes at 20°C+5°C-1°C, total 5 continuous cycles	Δ R/R max. ±(1%+0.05Ω ) No visible damage
Load Life (Endurance) Clause 4.25	1000 +48/-0 hours, loaded with RCWV or Vmax in chamber controller 70±2°C, 1.5 hours on and 0.5 hours off	Δ R/R max. ±(3%+0.1Ω )
Humidity Clause 4.24	1000 +48/-0 hours, loaded with RCWV or Vmax in humidity chamber controller at 40°C±C2°C and 90~95% relative humidity, 1.5hours on and 0.5 hours off	Δ R/R max. ±(3%+0.1Ω )



**THICK FILM CHIP RESISTORS CR12 SERIES**

**TEST AND REQUIREMENT** (JIS C 5201-1 : 1998)

TEST	PROCEDURE / TEST METHOD	REQUIREMENT
Bending strength Clause 4.33	Resistors mounted on a 90mm glass epoxy resin PCB(FR4); bending : 2 mm, once for 10 seconds.	$\Delta R/R$ max. $\pm(1\%+0.05\Omega)$
Adhesion Clause 4.32	Pressurizing force: 5N, Test time: 10 $\pm$ 1sec.	No remarkable damage or removal of the terminations.
Insulation Resistance Clause 4.6	Apply the maximum overload voltage (DC) for 1 minute	$R \geq 10G\Omega$
Dielectric Withstand Voltage Clause 4.7	Apply the maximum overload voltage (AC) for 1 minute	No breakdown or flashover

**TEST AND REQUIREMENTS** (JISC 5201-1:1998)

Essentially all tests are carried out according to the schedule of IEC publication 115-8, category LCT/UCT/56 (rated temperature range : Lower Category Temperature, Upper Category Temperature; damp heat, long term, 56 days). The testing also meets the requirements specified by EIA, EIAJ and JIS.

The tests are carried out in accordance with IEC publication 68, "Recommended basic climatic and mechanical robustness testing procedure for electronic components" and under standard atmospheric conditions according to IEC 60068-1, subclause 5.3. Unless otherwise specified, the following value supplied :

Temperature: 15°C to 35°C.

Relative humidity: 45% to 75%.

Air pressure: 86kPa to 106 kPa (860 mbar to 1060 mbar).

All soldering tests are performed with mildly activated flux.

**THICK FILM CHIP RESISTORS CR12 SERIES**

**REEL DIMENSION (Unit: mm)**

7": 4,000Ppcs/Reel

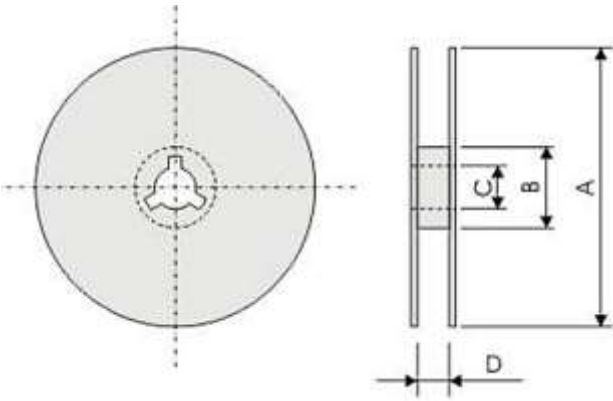

Code	Dimension 7"	Dimension 10"	Dimension 13"
A	178.0+/-2.0	254.0+/-2.0	330.0+/-2.0
B	60.0 +/-1.0	100 +/-1.0	100+/-1.0
C	13.0+/-0.20	13.0+/-0.20	13.0+/-0.20
D	12.4.0±1.00	14.0±0.20	14.0±0.20

**TAPE DIMENSION (Unit: mm)**

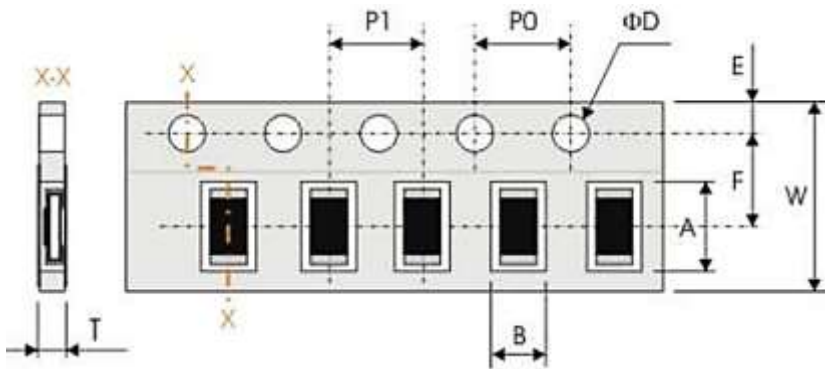

Code	Dimension
A	6.90±0.20
B	3.60±0.20
W	12.00±0.30
F	5.50±0.10
E	1.75±0.10
P 1	4.00±0. 10
P0	4.00±0.10
ΦD	1.50+0.10/-0.00
T	1.2 Max.

**TAPING QUANTITY AND TAPE MATERIAL**

Tape	Paper Tape						Embossed Tape	Bulk Cassette
	4 mm Pitch			2 mm Pitch			4 mm Pitch	
Reel Size	7"	10"	13"	7"	10"	13"	7"	
CR12	-	-	-	4000	8000	16000	-	-

## THICK FILM CHIP RESISTORS CR12 SERIES

### PERFORMANCE OF TAPING

#### Strength of Carrier Tape and Top Cover Tape

Carrier Tape: When a tensile force 1.02kgf is applied in the direction of unreeling the tape, the tape shall withstand this force. Top cover Tape: When a tensile force 1.02kgf is applied to the tape, the tape shall withstand this force.

#### Peel Force of Top Cover Tape

Unless otherwise specified, the peel force of top cover tape shall be 10.2 to 71.4 g f when the top cover tape is pulled at a speed of 300mm/min with the angle between the taped during peel and the direction of unreeling maintained at 165 to 180° as illustrated in Fig.

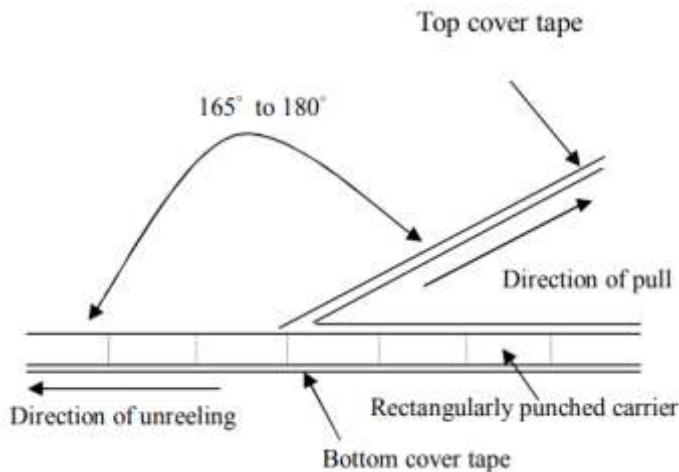

## THICK FILM CHIP RESISTORS CR12 SERIES

### ROHS COMPLIANCE

- The levels of RoHS restricted materials in this product are below the maximum concentration values (also referred to as the threshold limits) permitted for such substances, or are used in an exempted application, in accordance with EU RoHS Directive (EU) 2015/863 EC (RoHS3). RoHS Test Report for this product can be obtained can be obtained at Download Center.

### REACH COMPLIANCE

- REACH substances of high concern (SVHCs) information is available for this product. Since the European Chemical Agency (ECHA) has published notice of their intent to frequently revise the SVHC listing for the foreseeable future, REACH Test Report for this product can be obtained can be obtained at Download Center.

### IMPORTANT NOTES AND DISCLAIMER

1. All Product parametric performance is indicated in the Electrical Characteristics for the listed herein test conditions, unless otherwise noted. Product performance may not be indicated by the Electrical Characteristics if operated under different conditions.
2. NextGen Component, Inc (*NextGen*) reserves the right to make changes to this document and its products and specifications at any time without notice. Customers should obtain and confirm the latest product information and specifications before final design, purchase or use.
3. *NextGen* makes no warranty, representation or guarantee regarding the suitability of its products for any particular purpose, not does NextGen assume any liability for application assistance or customer product design.
4. *NextGen* does not warrant or accept any liability with products which are purchased or used for any unintended or unauthorized application. No license is granted by implication or otherwise under any intellectual property rights of NextGen.
5. *NextGen* products are not authorized for use as critical components in life support devices or systems without express written approval by *NextGen*.
6. *NextGen* requires that customers first obtain an RMA (Returned Merchandise Authorization) number prior to returning any products. Returns must be made within 30 days of the date of invoice, be in the original packaging, unused and like-new condition. At the time of quoting or purchasing, a product may say that it is Non-Cancelable/ Non-Returnable (NCNR). These products are not returnable and not refundable.