



SPECIFICATION SHEET

| | |
|--------------------------------|--|
| SPECIFICATION SHEET NO. | Q0607- CRCL06FBR40S01 |
| DATE | June. 7, 2023 |
| REVISION | A0 |
| DESCRIPTION | Thick Film Low Ohm Chip Resistors (High power rating and low TCR), 1206 (3216 Metric), CL06 Series, Dimension L3.10*W1.60*H0.55mm, 2 Terminations, Tolerance: ±1.0%, Resistance 0.40 ohm, Dissipation Max. 1/3W @ 70°C, Temperature Coefficient Rate (TCR) Max. ±100ppm/°C Operating Temp. Range -55°C ~+155°C Package in Tape/Reel, 5,000pcs/Reel RoHS/RoHS III compliant and HF |
| CUSTOMER | |
| CUSTOMER PART NUMBER | |
| CROSS REF. PART NUMBER | |
| ORIGINAL PART NUMBER | Aillen CL06FBR40 |
| PART CODE | CRCL06FBR40S01 |

| | | | |
|-------------------------|---|--|---|
| VENDOR APPROVE | | | |
| Issued/Checked/Approved |  |  |  |
| DATE: June. 7, 2023 | | | |

| | |
|-------------------------|--|
| CUSTOMER APPROVE | |
| | |
| DATE: | |

6/7/2023

THICK FILM LOW OHM CL06 SERIES

DESCRIPTION

The resistors are constructed in a high grade ceramic body (aluminum oxide). Internal metal electrodes are added at each end and connected by a resistive paste that is applied to the top surface of the substrate. The composition of the paste is adjusted to give the approximate resistance required and the value is trimmed to within tolerance by laser cutting of this resistive layer. The resistive layer is covered with a protective coat. Finally, the two external end terminations are added. For ease of soldering the outer layer of these end terminations is a Tin (lead free) alloy.



MAIN FEATURE

- High power rating and low TCR
- High reliability and stability
- Reduced size of final equipment
- RoHS exemption free and Lead free products

APPLICATION

- Power supply / Battery Pack
- Battery charger/ PC
- DC-DC power converter

RFQ

[Request For Quotation](#)

PART CODE GUIDE

| CRCL | 06 | F | B | R40 | S01 |
|------|----|---|---|-----|-----|
| 1 | 2 | 3 | 4 | 5 | 6 |

- 1) **CRCL**: Product code for Thick Film Low Ohm Chip Resistors
- 2) **06**: Size Code, 1206 (3216 Metric), CL06 Series, Dimension L3.10*W1.60*H0.55mm,
- 3) **F**: Resistance Range Tolerance Code, P: Jumper; B: +/-0.1%; D: +/-0.5%; F: +/-1%; J: +/-5%
- 4) **B**: Package Code, A: 4Kpcs/7"Reel; B:5kpcs/7"Reel; C:10kpcs/7"Reel; M:15kpcs/7"Reel; D:10kpcs/10"Reel; E:20kpcs/10"Reel
- 5) **R40**: Resistance value code. 0R: 0ohm; R40: 0.40ohm; 15R: 15ohm; 20R: 20ohm; 39R: 39ohm; 51R: 51ohm; 100R: 100ohm; 390R: 390ohm; 1K:1Kohm; 1K87: 1.87Kohm; 4K7: 4.7Kohm; 10K: 10Kohm; 10K5: 10.5Kohm; 12K: 12 Kohm; 150K: 150Kohm; 226K: 226Kohm; 1M: 1.0Mohm; 1M2: 1.2Mohm
- 6) **S01**: Internal control code, digits and letter; Blank: N/A

THICK FILM LOW OHM CL06 SERIES

DIMENSION (Unit: mm)

Image for reference



General Marking:

4-digits marking

*Each resistor is marked with a four digits code on the protective coating to designate the nominal resistance value

CL06 series

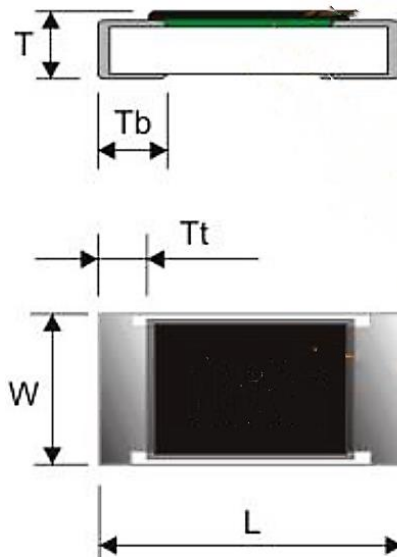

| Item | Dimension |
|------|-----------|
| L | 3.10±0.10 |
| W | 1.60±0.10 |
| T | 0.55±0.10 |
| T b | 0.50±0.25 |
| T t | 0.50±0.25 |

Resistors Construction For Reference

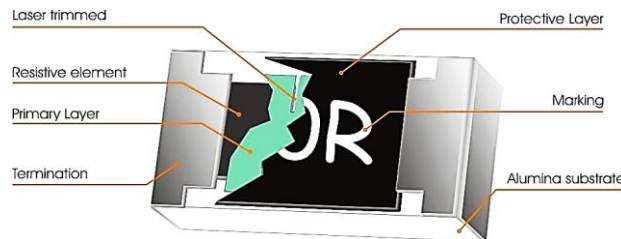

Recommended Solder Pad

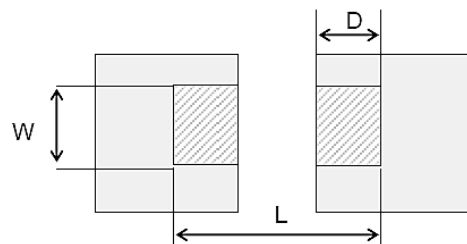

| Item | Dimension |
|------|-----------|
| W | 1.80 |
| L | 4.70 |
| D | 1.30 |

THICK FILM LOW OHM CL06 SERIES
GENERAL ELECTRONICAL CHARACTERISTICS

| Item | | Unit | Symbol | Characteristic | Condition |
|-----------------------|-------------------|--------|--------|-------------------------------------|-------------|
| Product Name | | | CRCL | Thick Film Low Ohm Chip Resistors | |
| Size | | | 06 | CL06 Series, L3.10*W1.60*H0.55mm | |
| Resistance Range | | Ω | | 0.40 | |
| Resistance Tolerance | | % | F | ±1.0% | |
| TCR | 20MΩ≥ R>10MΩ | ppm/°C | | ≤ ±1000 | |
| | 39MΩ≥ R>22MΩ | | | ≤ ±600 | |
| | 47MΩ≥ R>40MΩ | | | ≤ ±200 | |
| | 91MΩ≥ R>50MΩ | | | ≤ ±100 | |
| | 910MΩ≥ R>100MΩ | | | ≤ ±100 | |
| Max. Dissipation | | W | | 1/3 | @ Tamb=70°C |
| Operating Temperature | | °C | | -55 ~+155 | |

1) This is the maximum voltage that may be continuously supplied to the resistor element, see "IEC publication 60115-8"

2) Max. Operation Voltage : So called RCWV (Rated Continuous Working Voltage) is determined by

$$RCWV = \sqrt{\text{Rated Power} \times \text{Resistance Value}} \text{ or Max. RCWV listed above, whichever is lower.}$$

3) Test condition for jumper (0 Ω)

PRODUCT CHARACTERIZATION

Standard values of nominal resistance are taken from the E24 & E96 series for resistors with a tolerance of $\pm 0.1\%$, $\pm 0.5\%$, $\pm 1\%$ & $\pm 5\%$. The values of the E24/E96 series are in accordance with "IEC publication 60063"

DERATING

The power that the resistor can dissipate depends on the operating temperature; see Fig.1

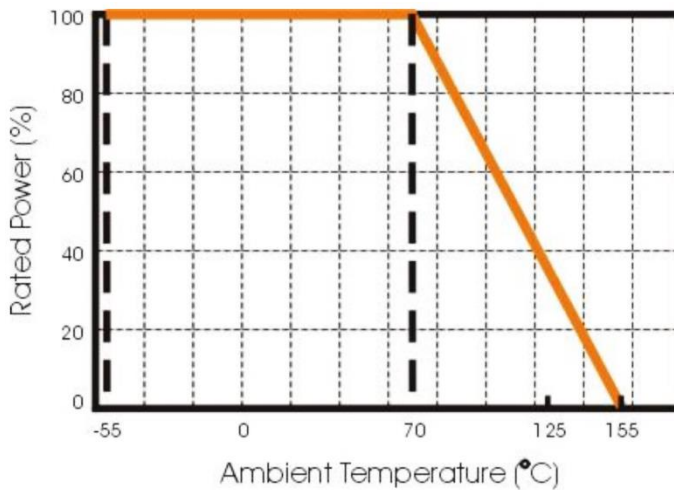

Fig 1 Maximum dissipation in percentage of rated power as a function of the ambient temperature

MOUNTING

Due to their rectangular shapes and small tolerances, Surface Mountable Resistors are suitable for handling by automatic placement systems. Chip placement can be on ceramic substrates and printed-circuit boards (PCBs). Electrical connection to the circuit is by individual soldering condition. The end terminations guarantee a reliable contact.

REFLOW SOLDERING CONDITION

The robust construction of chip resistors allows them to be completely immersed in a solder bath of 260 °C for 10 seconds. Therefore, it is possible to mount Surface Mount Resistors on one side of a PCB and other discrete components on the reverse (mixed PCBs). Surface Mount Resistors are tested for solderability at 235 °C during 2 seconds. The test condition for no leaching is 260°C for 30 seconds. Typical examples of soldering processes that provide reliable joints without any damage are given in Fig 2.

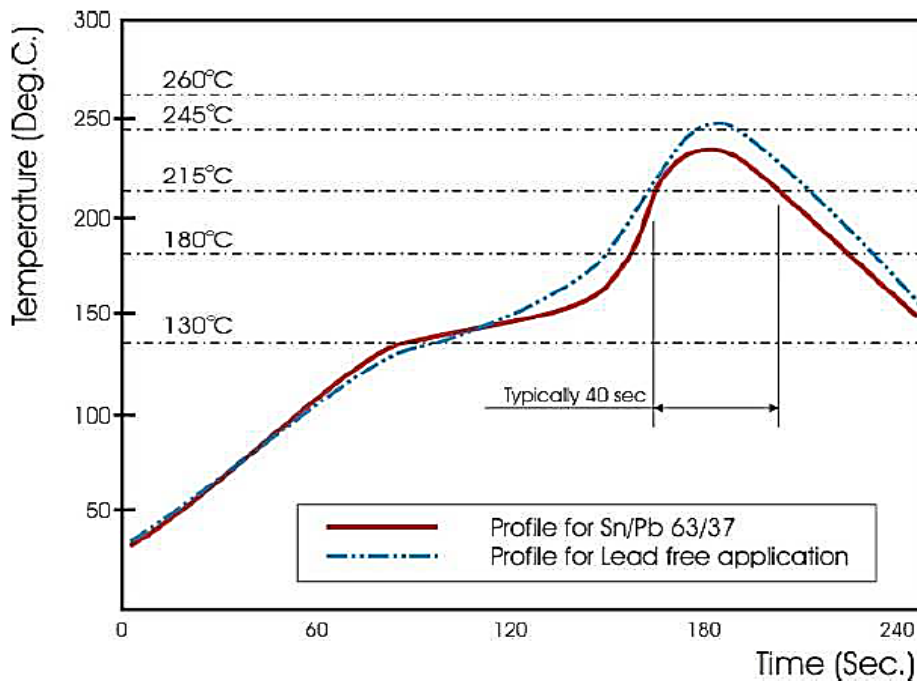

Fig 2. Infrared soldering profile for Chip Resistors

THICK FILM LOW OHM CL06 SERIES
TEST AND REQUIREMENT (JIS C 5201-1 : 1998)

| TEST | PROCEDURE / TEST METHOD | REQUIREMENT |
|---|--|---|
| Temperature Coefficient of Resistance(T.C.R) Clause 4.8 | Natural resistance change per change in degree centigrade. $\frac{R_2 - R_1}{R_1(t_2 - t_1)} \times 10^6 \text{ (ppm/}^\circ\text{C)}$ t1 : 25°C R1 : Resistance at reference temperature 25°C R2: Resistance at test temperature 155°C | Within the specified tolerance Refer to "QUICK REFERENCE DATA" |
| Short time overload (S.T.O.L) Clause 4.13 | Permanent resistance change after a 5second application of a 5 times rated power. | J: Δ R/R max. ±(2%+0.5mΩ) F: Δ R/R max. ±(1%+0.5mΩ) |
| Resistance to soldering heat(R.S.H) Clause 4.18 | Un-mounted chips completely immersed for 10±1second in a SAC solder bath at 260°C±5°C | J: Δ R/R max. ±(1%+0.5mΩ) F: Δ R/R max. ±(0.5%+0.5mΩ) no visible damage |
| Solderability Clause 4.17 | Un-mounted chips completely immersed for 2±0.8 second in a SAC solder bath at 235°C±5°C | 95% coverage min., good tinning and no visible damage |
| Temperature cycling Clause 4.19 | 30 minutes at -55°C±3°C, 2~3 minutes at 20°C+5°C-1°C, 30 minutes at +125°C±3°C, 2~3 minutes at 20°C+5°C1°C, total 5 continuous cycles | J: Δ R/R max. ±(1%+0.5mΩ) F: Δ R/R max. ±(0.5%+0.5mΩ) no visible damage |
| Damp Heat (Load life in humidity) Clause 4.24 | 1000 +48/-0 hours, loaded with RCWV or Vmax in humidity chamber controller at 40°C±2°C and 90~95% relative humidity, 1.5hours on and 0.5 hours off | J: Δ R/R max. ±(3%+0.5mΩ) F: Δ R/R max. ±(1%+0.5mΩ) |
| Load life (endurance) JISC5201-1: 1998 Clause 4.25 | 1000 +48/-0 hours, loaded with RCWV or Vmax in chamber controller 70±2°C, 1.5 hours on and 0.5 Hours off | J: Δ R/R max. ±(3%+0.5mΩ) F: Δ R/R max. ±(1%+0.5mΩ) |
| Bending strength Clause 4.33 | Resistors mounted on a 90mm glass epoxy resin PCB(FR4); bending : 3mm for 0603/0805, 2mm for 1206 and above sizes, once for 10 seconds | J: Δ R/R max. ±(1%+0.5mΩ) F: Δ R/R max. ±(0.5%+0.5mΩ) no visible damage |
| Adhesion Clause 4.32 | Pressurizing force: 5N, Test time: 10±1sec. | No remarkable damage or removal of the terminations |
| Insulation Resistance Clause 4.6 | Test voltage: 100+/-15V | I.R≥1GΩ |

6/7/2023

THICK FILM CHIP RESISTORS CL06 SERIES
REEL DIMENSION (Unit: mm)

7": 5,000Ppcs/Reel

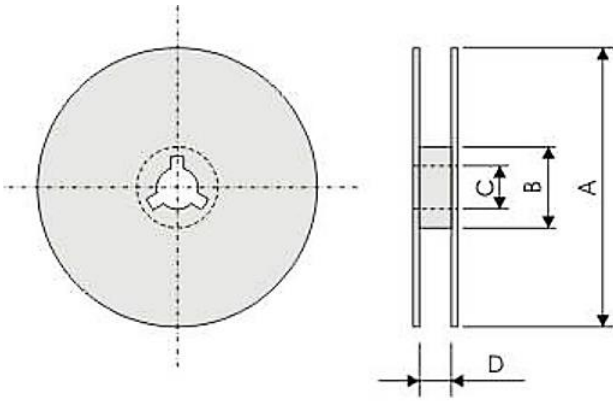

| Code | Dimension 7" | Dimension 10" | Dimension 13" |
|------|--------------|---------------|---------------|
| A | 178.0+/-2.0 | 254.0+/-2.0 | 330.0+/-2.0 |
| B | 60.0 +/--1.0 | 100 +/--1.0 | 100+/--1.0 |
| C | 13.0+/-0.20 | 13.0+/-0.20 | 13.0+/-0.20 |
| D | 10.0±1.5 | 10.0±1.5 | 10.0±1.5 |

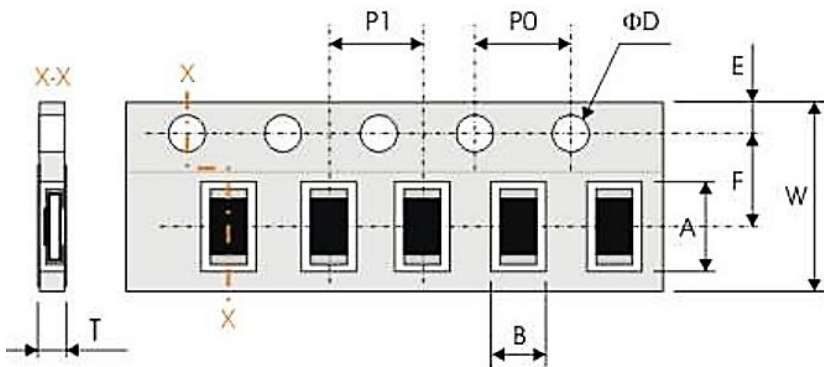
TAPE DIMENSION (Unit: mm)

| Code | Dimension |
|------|-----------|
| A | 3.60±0.20 |
| B | 2.00±0.20 |
| W | 8.00±0.30 |
| F | 3.50±0.20 |
| E | 1.75±0.10 |
| P 1 | 4.00±0.10 |
| P0 | 4.00±0.10 |
| ΦD | 1.50±0.10 |
| T | 1.0 Max. |

TAPING QUANTITY AND TAPE MATERIAL

| Tape | Paper Tape | | | | | | Embossed Tape | Bulk Cassette |
|-----------|------------|-------|-------|------------|-----|-----|---------------|---------------|
| | 4 mm Pitch | | | 2 mm Pitch | | | 4 mm Pitch | |
| Reel Size | 7" | 10" | 13" | 7" | 10" | 13" | 7" | |
| CL06 | 5000 | 10000 | 20000 | - | - | - | - | 5000 |

PERFORMANCE OF TAPING

Strength of Carrier Tape and Top Cover Tape

Carrier Tape: When a tensile force 1.02kgf is applied in the direction of unreeling the tape, the tape shall withstand this force. Top cover Tape: When a tensile force 1.02kgf is applied to the tape, the tape shall withstand this force.

Peel Force of Top Cover Tape

Unless otherwise specified, the peel force of top cover tape shall be 10.2 to 71.4 g f when the top cover tape is pulled at a speed of 300mm/min with the angle between the taped during peel and the direction of unreeling maintained at 165 to 180° as illustrated in Fig.

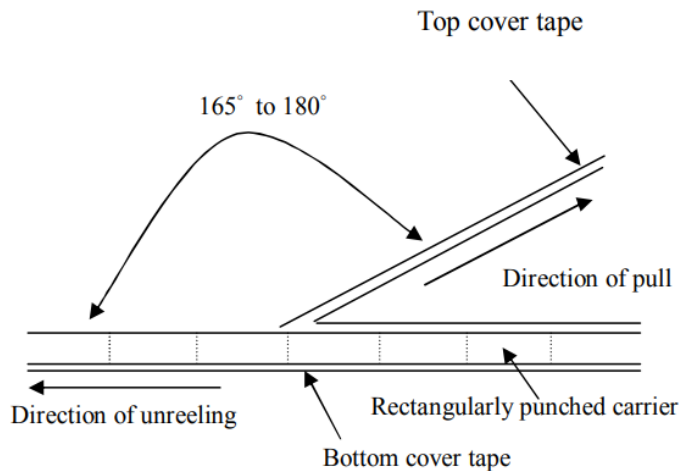

DISCLAIMER

NextGen Component, Inc. reserves the right to make changes to the product(s) and or information contained herein without notice. No liability is assumed as a result of their use or application. No rights under any patent accompany the sale of any such product(s) or information