

Preliminary datasheet

EasyPACK™ module with CoolSiC™ Trench MOSFET and PressFIT / NTC

Features

- Electrical features
 - $V_{DSS} = 1200\text{ V}$
 - $I_{DN} = 63\text{ A} / I_{DRM} = 125\text{ A}$
 - Low switching losses
 - Low inductive design
- Mechanical features
 - PressFIT contact technology
 - AlN substrate with low thermal resistance
 - Integrated NTC temperature sensor
 - Rugged mounting due to integrated mounting clamps



Typical appearance

Potential applications

- High-frequency switching application
- Motor drives
- UPS systems
- DC/DC converter
- DC charger for EV

Product validation

- Qualified for industrial applications according to the relevant tests of IEC 60747, 60749 and 60068

Description

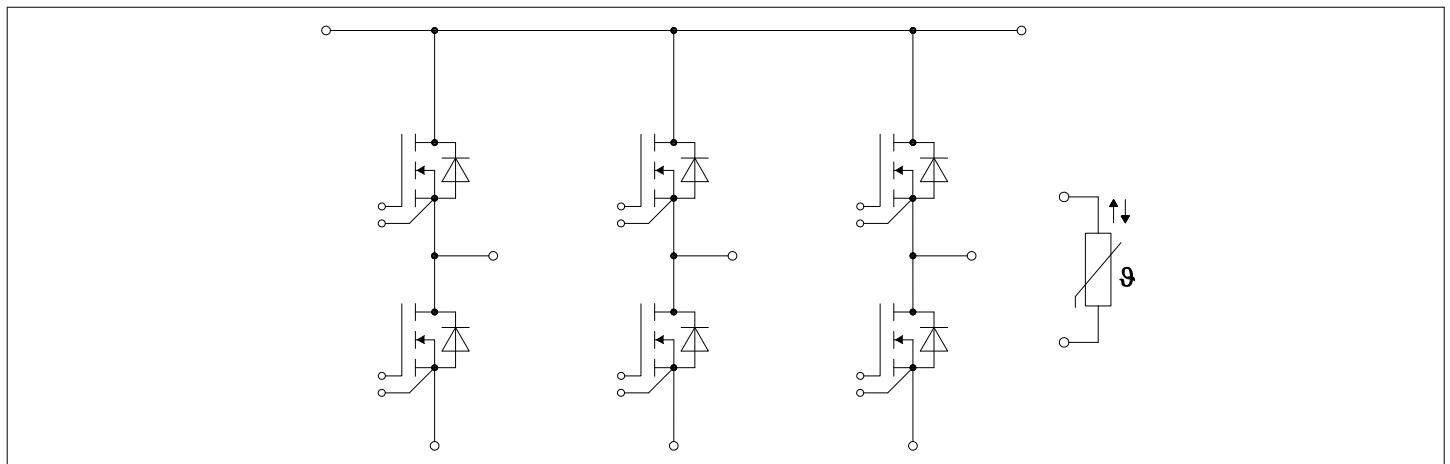

Table of contents

	Description	1
	Features	1
	Potential applications	1
	Product validation	1
	Table of contents	2
1	Package	3
2	MOSFET	3
3	Body diode (MOSFET)	5
4	NTC-Thermistor	6
5	Characteristics diagrams	7
6	Circuit diagram	12
7	Package outlines	13
8	Module label code	14
	Revision history	15
	Disclaimer	16

1 Package

Table 1 Insulation coordination

Parameter	Symbol	Note or test condition	Values	Unit
Isolation test voltage	V_{ISOL}	RMS, $f = 50 \text{ Hz}$, $t = 1 \text{ min}$	3.0	kV
Internal isolation		basic insulation (class 1, IEC 61140)	AIN	
Comparative tracking index	CTI		> 200	
Relative thermal index (electrical)	RTI	housing	140	°C

Table 2 Characteristic values

Parameter	Symbol	Note or test condition	Values			Unit
			Min.	Typ.	Max.	
Stray inductance module	L_{sCE}			13		nH
Module lead resistance, terminals - chip	$R_{CC'+EE'}$	$T_H = 25 \text{ °C}$, per switch		4.6		mΩ
Storage temperature	T_{stg}		-40		125	°C
Mounting force per clamp	F		40		80	N
Weight	G			39		g

Note: The current under continuous operation is limited to 25 A rms per connector pin.
 Functional isolation applies for the NTC inside module, detailed description refers to AN2009-10, chapter 2.1.
 A isolation test voltage of 1.5kV RMS, $f = 50\text{Hz}$, $t = 1\text{min}$ is applied between NTC and the other components inside module.

2 MOSFET

Table 3 Maximum rated values

Parameter	Symbol	Note or test condition	Values	Unit
Drain-source voltage	V_{DSS}	$T_{vj} = 25 \text{ °C}$	1200	V
Continuous DC drain current	I_{DDC}	$T_{vj} = 175 \text{ °C}$, $V_{GS} = 18 \text{ V}$ $T_H = 90 \text{ °C}$	62.5	A
Repetitive peak drain current	I_{DRM}	verified by design, t_p limited by T_{vjmax}	125	A
Gate-source voltage, max. transient voltage	V_{GS}	$D < 0.01$	-10/23	V
Gate-source voltage, max. static voltage	V_{GS}		-7/20	V

Table 4 Recommended values

Parameter	Symbol	Note or test condition	Values	Unit
On-state gate voltage	$V_{GS(on)}$		15...18	V
Off-state gate voltage	$V_{GS(off)}$		-5...0	V

Table 5 Characteristic values

Parameter	Symbol	Note or test condition	Values			Unit	
			Min.	Typ.	Max.		
Drain-source on-resistance	$R_{DS(on)}$	$I_D = 62.5 \text{ A}$	$V_{GS} = 18 \text{ V}, T_{vj} = 25 \text{ °C}$		11.7		mΩ
			$V_{GS} = 18 \text{ V}, T_{vj} = 125 \text{ °C}$		18.9		
			$V_{GS} = 18 \text{ V}, T_{vj} = 150 \text{ °C}$		21.7		
			$V_{GS} = 15 \text{ V}, T_{vj} = 25 \text{ °C}$		14		
Gate threshold voltage	$V_{GS(th)}$	$I_D = 28 \text{ mA}, V_{DS} = V_{GS}, T_{vj} = 25 \text{ °C},$ (tested after 1ms pulse at $V_{GS} = +20 \text{ V}$)	3.45	4.3	5.15	V	
Total gate charge	Q_G	$V_{DD} = 800 \text{ V}, V_{GS} = -3/18 \text{ V}$		0.2		μC	
Internal gate resistor	R_{Gint}	$T_{vj} = 25 \text{ °C}$		7.5		Ω	
Input capacitance	C_{ISS}	$f = 100 \text{ kHz}, V_{DS} = 800 \text{ V}, V_{GS} = 0 \text{ V}, T_{vj} = 25 \text{ °C}$		6.05		nF	
Output capacitance	C_{OSS}	$f = 100 \text{ kHz}, V_{DS} = 800 \text{ V}, V_{GS} = 0 \text{ V}, T_{vj} = 25 \text{ °C}$		0.3		nF	
Reverse transfer capacitance	C_{rss}	$f = 100 \text{ kHz}, V_{DS} = 800 \text{ V}, V_{GS} = 0 \text{ V}, T_{vj} = 25 \text{ °C}$		0.02		nF	
C_{OSS} stored energy	E_{OSS}	$V_{DS} = 800 \text{ V}, V_{GS} = -3/18 \text{ V}, T_{vj} = 25 \text{ °C}$		118		μJ	
Drain-source leakage current	I_{DSS}	$V_{DS} = 1200 \text{ V}, V_{GS} = -3 \text{ V}, T_{vj} = 25 \text{ °C}$		0.04	111	μA	
Gate-source leakage current	I_{GSS}	$V_{DS} = 0 \text{ V}, T_{vj} = 25 \text{ °C}$	$V_{GS} = 20 \text{ V}$		400	nA	
Turn-on delay time (inductive load)	$t_{d on}$	$I_D = 62.5 \text{ A}, R_{Gon} = 5.1 \text{ Ω}, V_{DD} = 600 \text{ V}, V_{GS} = -3/18 \text{ V}$	$T_{vj} = 25 \text{ °C}$		58		ns
			$T_{vj} = 125 \text{ °C}$		58		
			$T_{vj} = 150 \text{ °C}$		58		
Rise time (inductive load)	t_r	$I_D = 62.5 \text{ A}, R_{Gon} = 5.1 \text{ Ω}, V_{DD} = 600 \text{ V}, V_{GS} = -3/18 \text{ V}$	$T_{vj} = 25 \text{ °C}$		15		ns
			$T_{vj} = 125 \text{ °C}$		15		
			$T_{vj} = 150 \text{ °C}$		15		

(table continues...)

Table 5 (continued) **Characteristic values**

Parameter	Symbol	Note or test condition	Values			Unit	
			Min.	Typ.	Max.		
Turn-off delay time (inductive load)	$t_{d\text{off}}$	$I_D = 62.5\text{ A}$, $R_{G\text{off}} = 5.1\ \Omega$, $V_{DD} = 600\text{ V}$, $V_{GS} = -3/18\text{ V}$	$T_{vj} = 25\text{ }^\circ\text{C}$		114	ns	
			$T_{vj} = 125\text{ }^\circ\text{C}$		126		
			$T_{vj} = 150\text{ }^\circ\text{C}$		129		
Fall time (inductive load)	t_f	$I_D = 62.5\text{ A}$, $R_{G\text{off}} = 5.1\ \Omega$, $V_{DD} = 600\text{ V}$, $V_{GS} = -3/18\text{ V}$	$T_{vj} = 25\text{ }^\circ\text{C}$		34	ns	
			$T_{vj} = 125\text{ }^\circ\text{C}$		36		
			$T_{vj} = 150\text{ }^\circ\text{C}$		37		
Turn-on energy loss per pulse	E_{on}	$I_D = 62.5\text{ A}$, $V_{DD} = 600\text{ V}$, $L_\sigma = 35\text{ nH}$, $V_{GS} = -3/18\text{ V}$, $R_{Gon} = 5.1\ \Omega$, $di/dt = 3.2\text{ kA}/\mu\text{s}$ ($T_{vj} = 150\text{ }^\circ\text{C}$)	$T_{vj} = 25\text{ }^\circ\text{C}$		1.39	mJ	
			$T_{vj} = 125\text{ }^\circ\text{C}$		1.57		
			$T_{vj} = 150\text{ }^\circ\text{C}$		1.64		
Turn-off energy loss per pulse	E_{off}	$I_D = 62.5\text{ A}$, $V_{DD} = 600\text{ V}$, $L_\sigma = 35\text{ nH}$, $V_{GS} = -3/18\text{ V}$, $R_{Goff} = 5.1\ \Omega$, $dv/dt = 13\text{ kV}/\mu\text{s}$ ($T_{vj} = 150\text{ }^\circ\text{C}$)	$T_{vj} = 25\text{ }^\circ\text{C}$		1.06	mJ	
			$T_{vj} = 125\text{ }^\circ\text{C}$		1.14		
			$T_{vj} = 150\text{ }^\circ\text{C}$		1.15		
Thermal resistance, junction to heat sink	R_{thJH}	per MOSFET, $\lambda_{grease} = 1\text{ W}/(\text{m}\cdot\text{K})$			0.661	K/W	
Temperature under switching conditions	$T_{vj\text{op}}$			-40		150	$^\circ\text{C}$

Note: The selection of positive and negative gate-source voltages impacts losses and the long-term behavior of the MOSFET and body diode. The design guidelines described in Application Note AN 2018-09 and AN 2021-13 must be considered to ensure sound operation of the device over the planned lifetime.

3 Body diode (MOSFET)

Table 6 Maximum rated values

Parameter	Symbol	Note or test condition	Values	Unit
DC body diode forward current	I_{SD}	$T_{vj} = 175\text{ }^\circ\text{C}$, $V_{GS} = -3\text{ V}$, $T_H = 90\text{ }^\circ\text{C}$	30	A

Table 7 Characteristic values

Parameter	Symbol	Note or test condition	Values			Unit	
			Min.	Typ.	Max.		
Forward voltage	V_{SD}	$I_{SD} = 62.5\text{ A}$, $V_{GS} = -3\text{ V}$	$T_{vj} = 25\text{ }^\circ\text{C}$		4.14	5.35	V
			$T_{vj} = 125\text{ }^\circ\text{C}$		3.88		
			$T_{vj} = 150\text{ }^\circ\text{C}$		3.82		

4 NTC-Thermistor

Table 8 Characteristic values

Parameter	Symbol	Note or test condition	Values			Unit
			Min.	Typ.	Max.	
Rated resistance	R_{25}	$T_{NTC} = 25\text{ °C}$		5		kΩ
Deviation of R_{100}	$\Delta R/R$	$T_{NTC} = 100\text{ °C}, R_{100} = 493\text{ }\Omega$	-5		5	%
Power dissipation	P_{25}	$T_{NTC} = 25\text{ °C}$			20	mW
B-value	$B_{25/50}$	$R_2 = R_{25} \exp[B_{25/50}(1/T_2 - 1/(298,15\text{ K}))]$		3375		K
B-value	$B_{25/80}$	$R_2 = R_{25} \exp[B_{25/80}(1/T_2 - 1/(298,15\text{ K}))]$		3411		K
B-value	$B_{25/100}$	$R_2 = R_{25} \exp[B_{25/100}(1/T_2 - 1/(298,15\text{ K}))]$		3433		K

Note: Specification according to the valid application note.

5 Characteristics diagrams

Output characteristic (typical), MOSFET

$I_D = f(V_{DS})$
 $V_{GS} = 18\text{ V}$

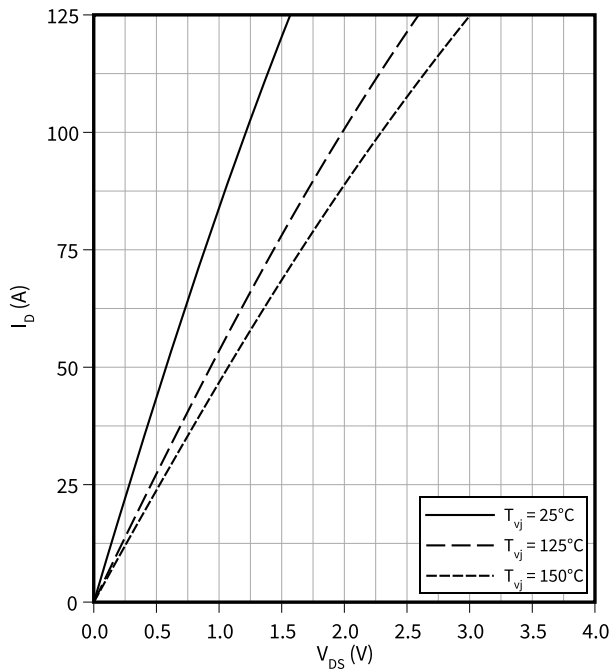

Output characteristic (typical), MOSFET

$I_D = f(V_{DS})$
 $V_{GS} = 15\text{ V}$

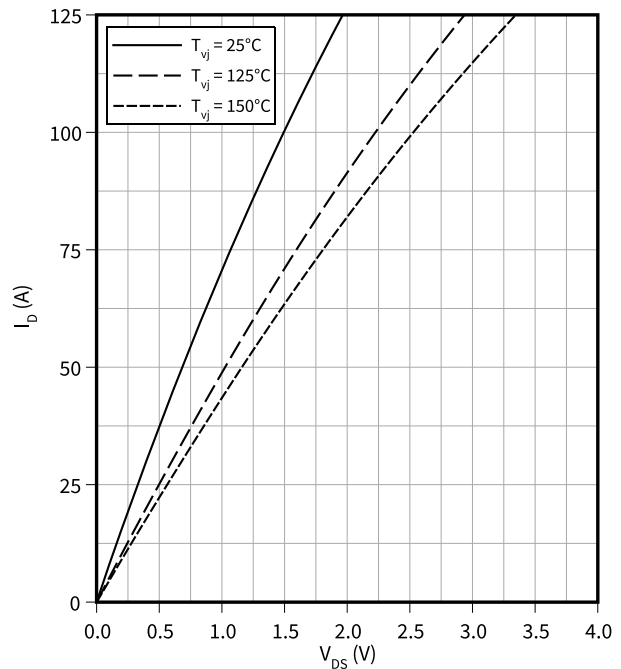

Drain source on-resistance (typical), MOSFET

$R_{DS(on)} = f(I_D)$
 $V_{GS} = 18\text{ V}$

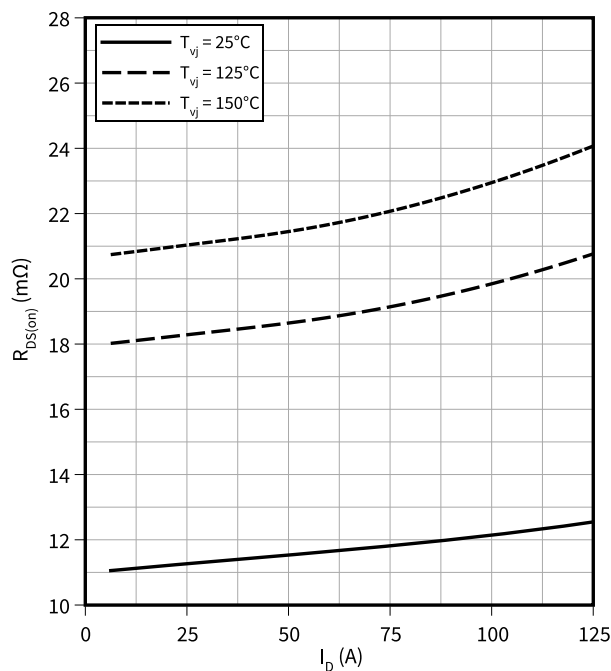

Drain source on-resistance (typical), MOSFET

$R_{DS(on)} = f(T_{vj})$
 $I_D = 62.5\text{ A}$

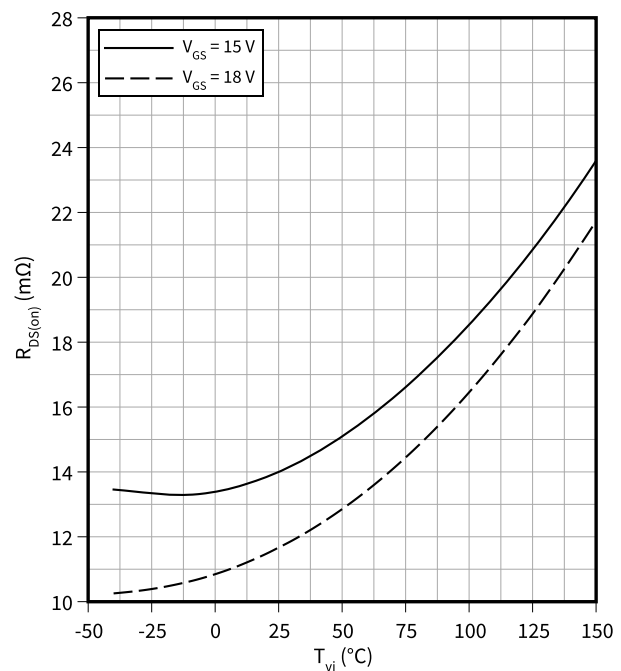

Output characteristic field (typical), MOSFET

$I_D = f(V_{DS})$
 $T_{vj} = 150\text{ °C}$

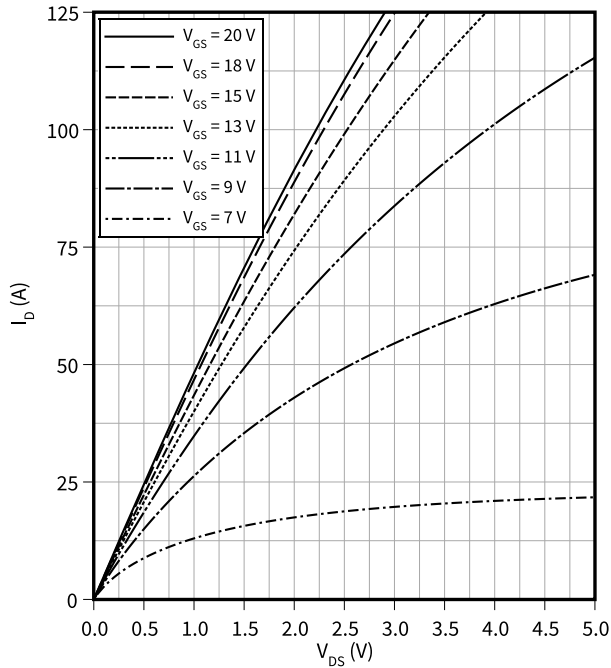

Transfer characteristic (typical), MOSFET

$I_D = f(V_{GS})$
 $V_{DS} = 20\text{ V}$

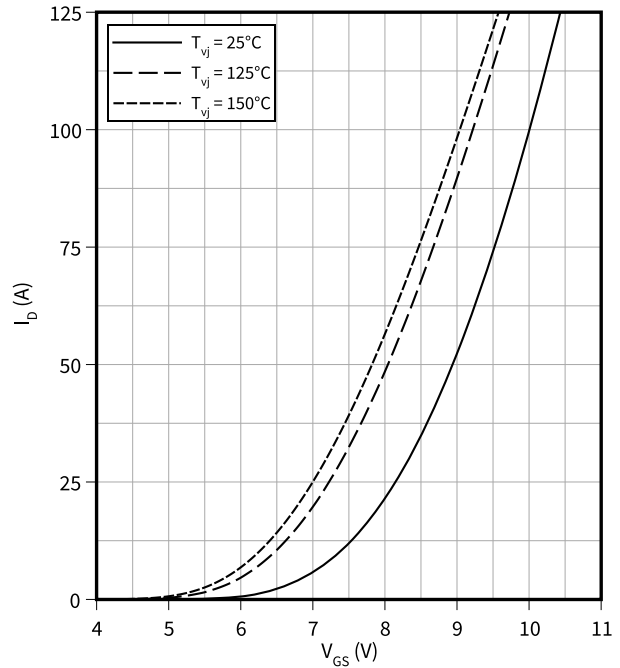

Gate-source threshold voltage (typical), MOSFET

$V_{GS(th)} = f(T_{vj})$
 $V_{GS} = V_{DS}$

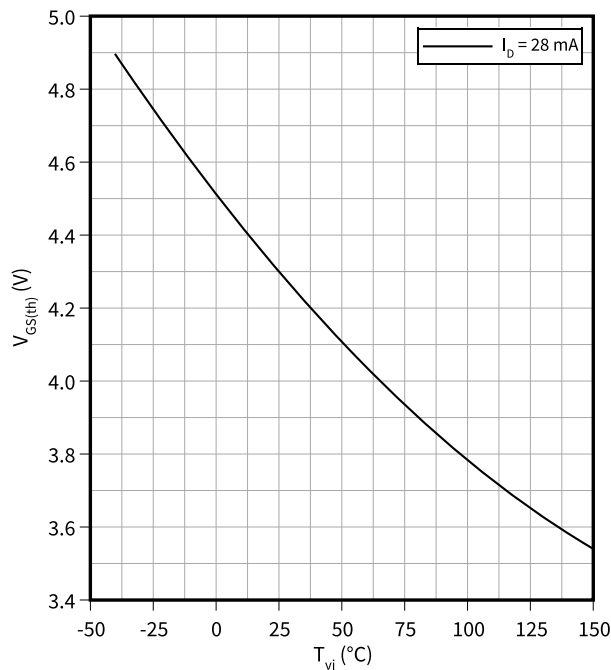

Gate charge characteristic (typical), MOSFET

$V_{GS} = f(Q_G)$
 $I_D = 62.5\text{ A}, T_{vj} = 25\text{ °C}$

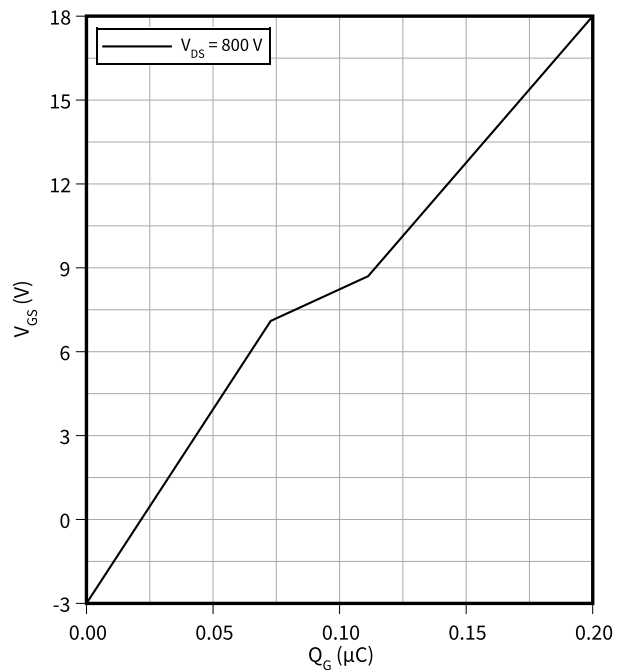

Capacity characteristic (typical), MOSFET

$C = f(V_{DS})$

$f = 100 \text{ kHz}, T_{vj} = 25 \text{ }^\circ\text{C}, V_{GS} = 0 \text{ V}$

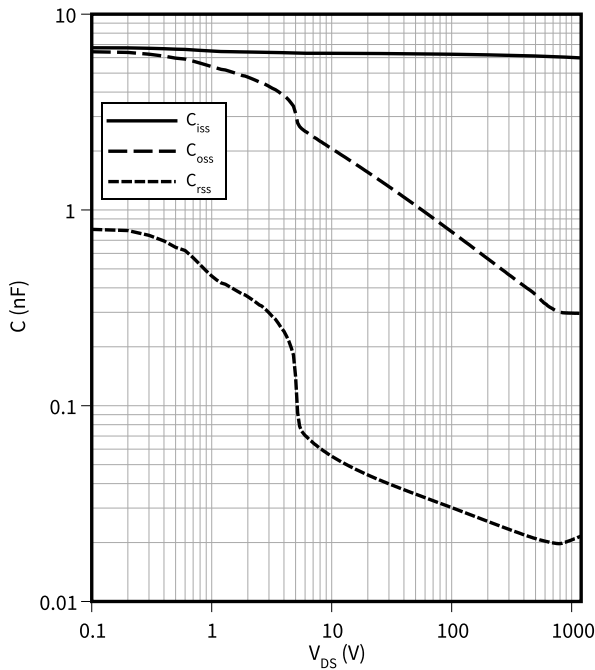

Forward characteristic body diode (typical), MOSFET

$I_{SD} = f(V_{SD})$

$T_{vj} = 25 \text{ }^\circ\text{C}$

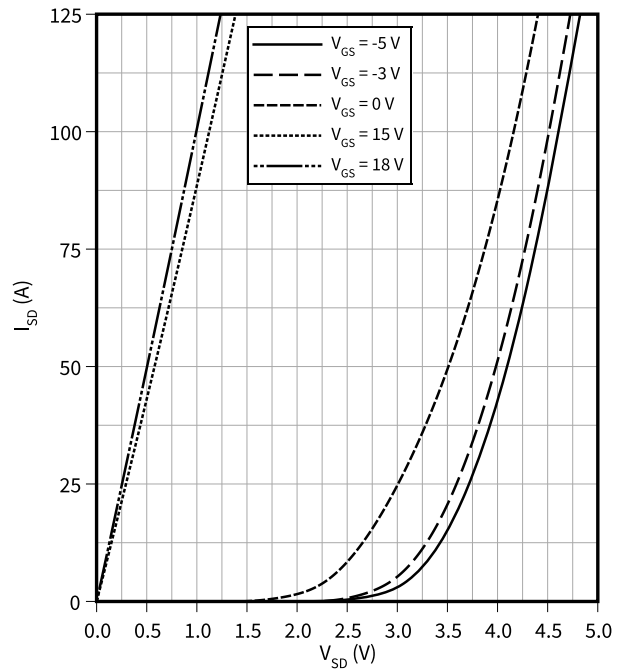

Forward voltage of body diode (typical), MOSFET

$V_{SD} = f(T_{vj})$

$I_{SD} = 62.5 \text{ A}$

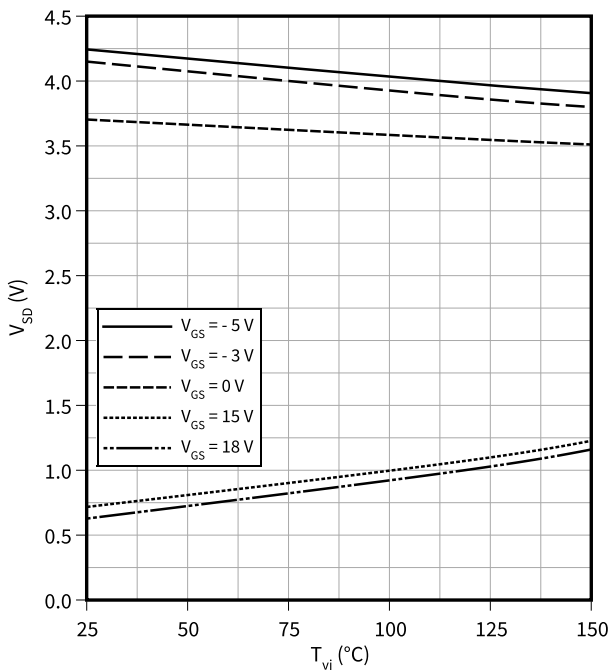

Switching losses (typical), MOSFET

$E = f(I_D)$

$R_{Goff} = 5.1 \text{ } \Omega, R_{Gon} = 5.1 \text{ } \Omega, V_{DD} = 600 \text{ V}, V_{GS} = -3/18 \text{ V}$

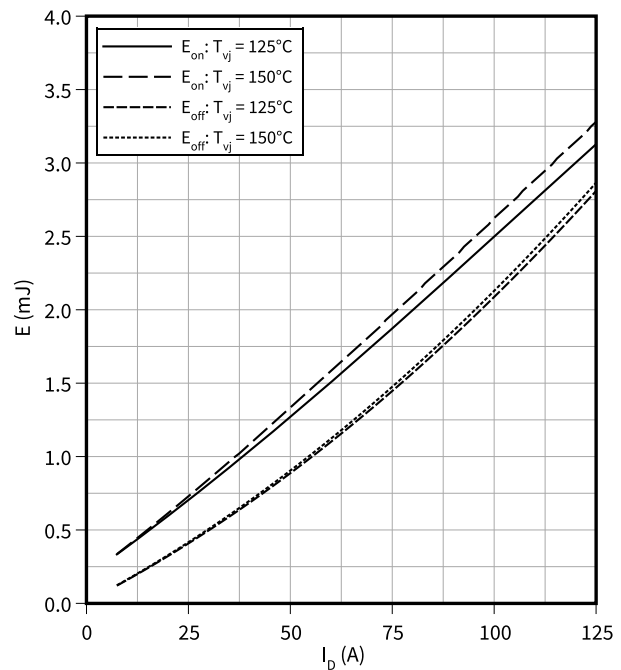

Switching losses (typical), MOSFET

$E = f(R_G)$

$V_{DD} = 600\text{ V}, I_D = 62.5\text{ A}, V_{GS} = -3/18\text{ V}$

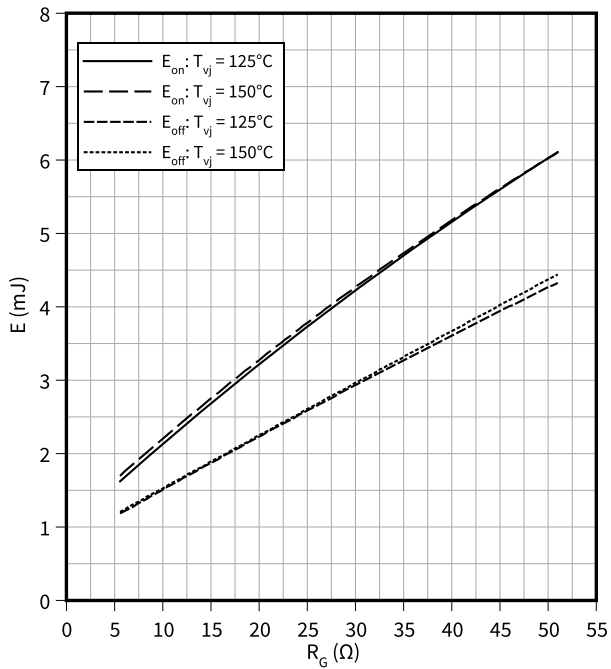

Switching times (typical), MOSFET

$t = f(I_D)$

$R_{Goff} = 5.1\ \Omega, R_{Gon} = 5.1\ \Omega, V_{DD} = 600\text{ V}, T_{vj} = 150\text{ }^\circ\text{C}, V_{GS} = -3/18\text{ V}$

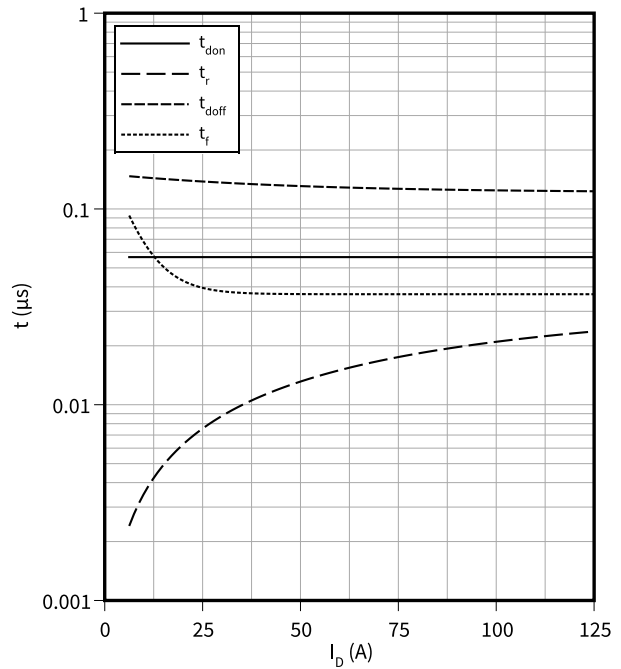

Switching times (typical), MOSFET

$t = f(R_G)$

$V_{DD} = 600\text{ V}, I_D = 62.5\text{ A}, T_{vj} = 150\text{ }^\circ\text{C}, V_{GS} = -3/18\text{ V}$

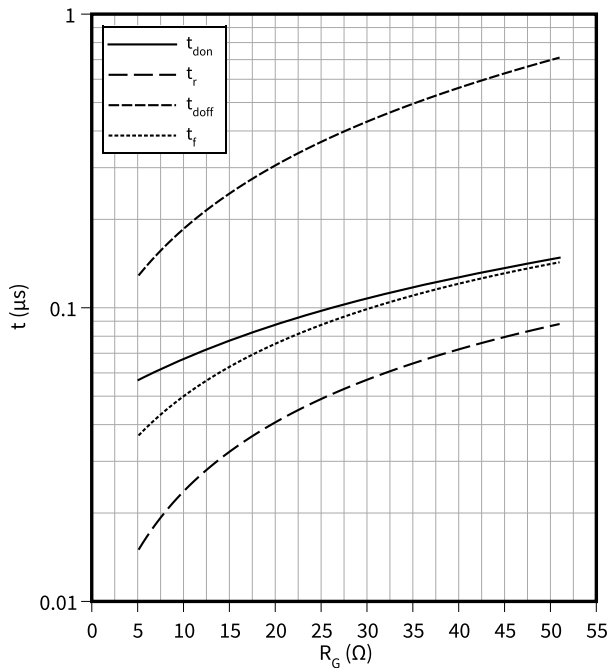

Current slope (typical), MOSFET

$di/dt = f(R_G)$

$V_{DD} = 600\text{ V}, I_D = 62.5\text{ A}, V_{GS} = -3/18\text{ V}$

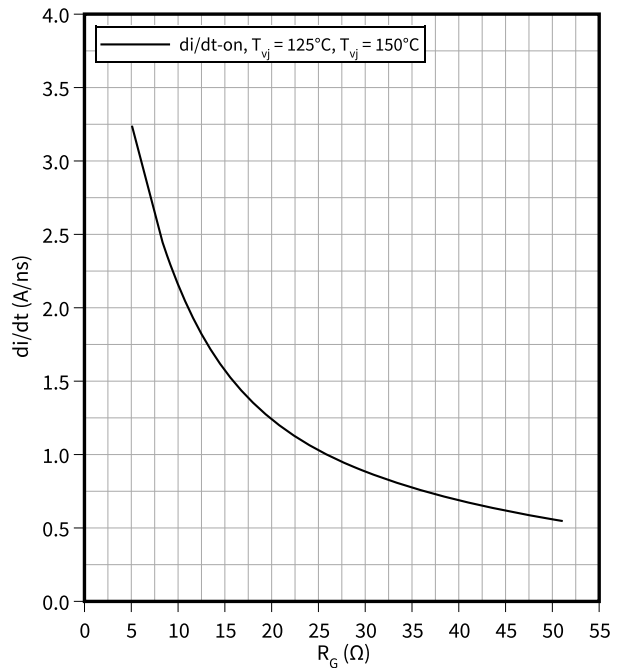

Voltage slope (typical), MOSFET

$dv/dt = f(R_G)$

$V_{DD} = 600\text{ V}, I_D = 62.5\text{ A}, V_{GS} = -3/18\text{ V}$

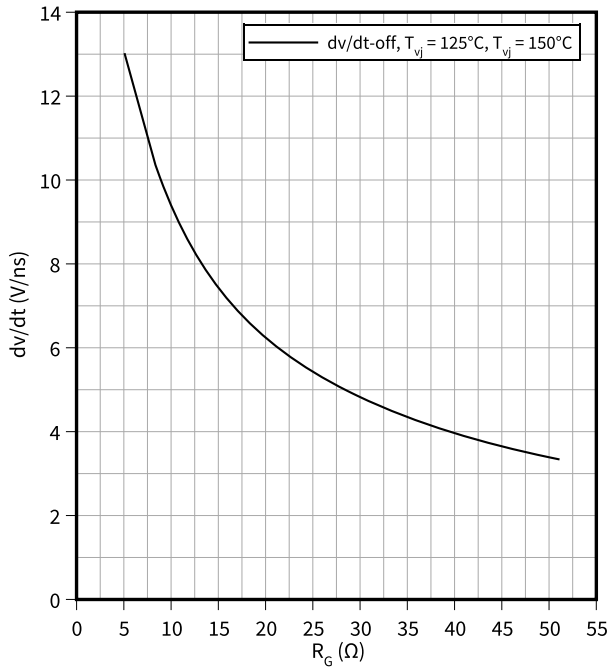

Reverse bias safe operating area (RBSOA), MOSFET

$I_D = f(V_{DS})$

$R_{Goff} = 5.1\ \Omega, T_{vj} = 150\ \text{°C}, V_{GS} = -3/18\text{ V}$

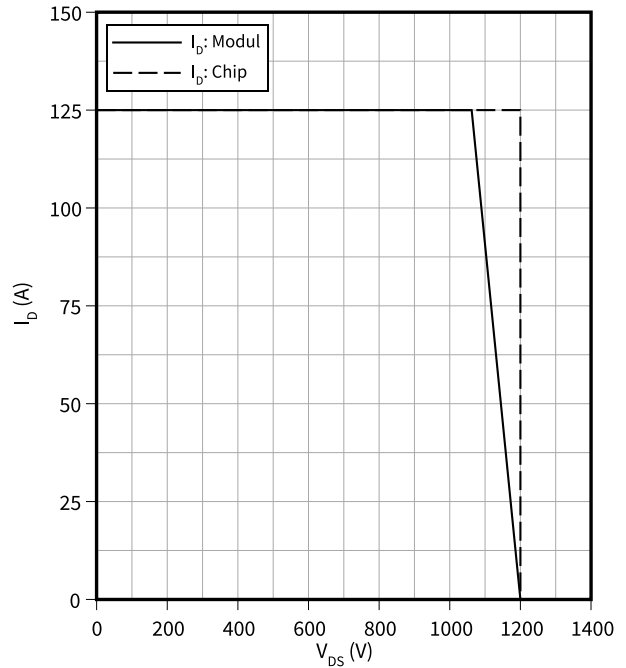

Transient thermal impedance, MOSFET

$Z_{th} = f(t)$

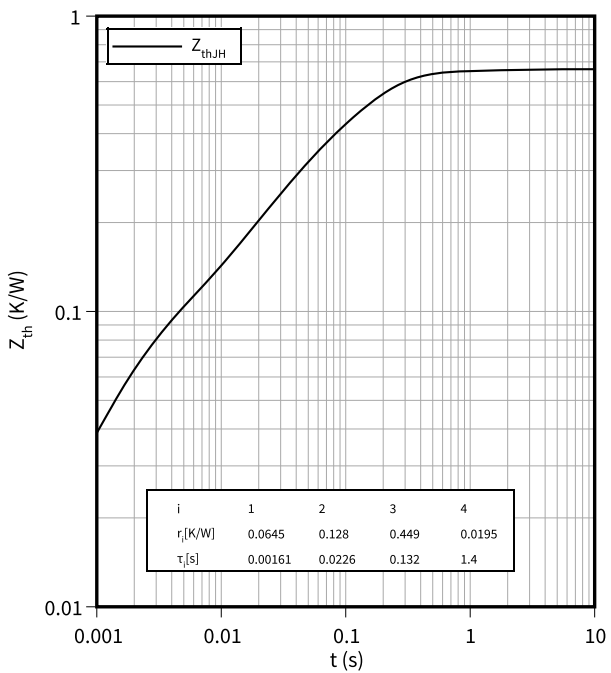

Temperature characteristic (typical), NTC-Thermistor

$R = f(T_{NTC})$

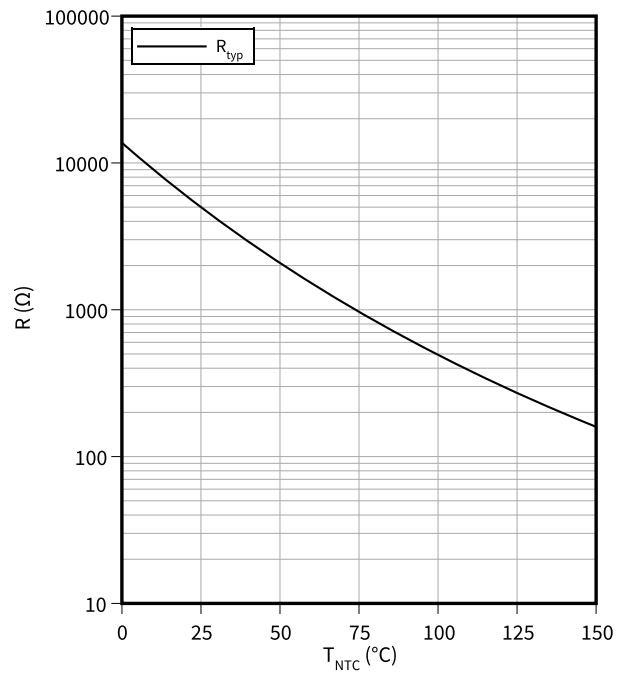

6 Circuit diagram

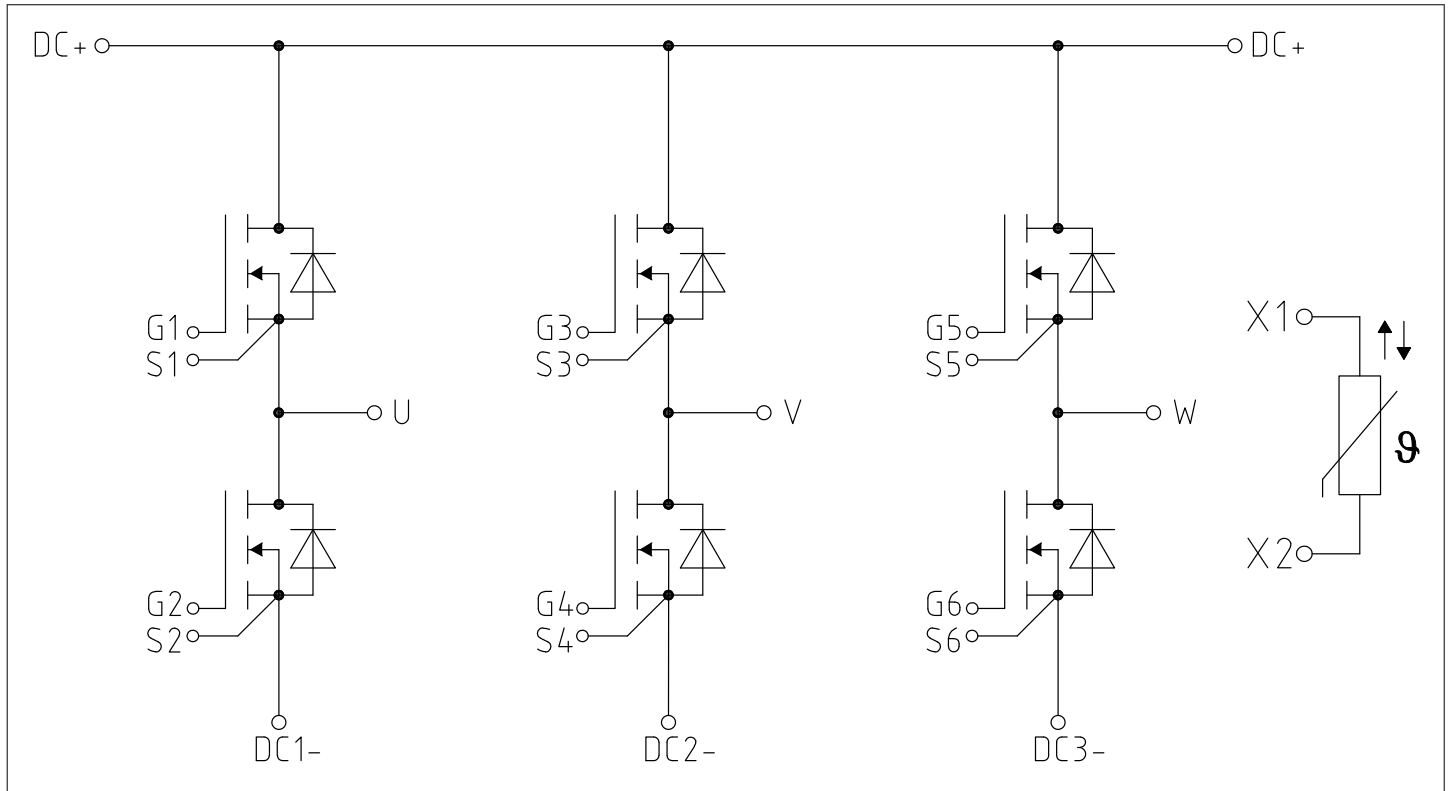

Figure 1

8 Module label code



Module label code			
Code format	Data Matrix	Barcode Code128	
Encoding	ASCII text	Code Set A	
Symbol size	16x16	23 digits	
Standard	IEC24720 and IEC16022	IEC8859-1	
Code content	<i>Content</i>	<i>Digit</i>	<i>Example</i>
	Module serial number	1 - 5	71549
	Module material number	6 - 11	142846
	Production order number	12 - 19	55054991
	Date code (production year)	20 - 21	15
	Date code (production week)	22 - 23	30
Example	 		
	71549142846550549911530		71549142846550549911530

Figure 3

Revision history

Document revision	Date of release	Description of changes
0.10	2022-03-18	Initial version
0.20	2022-06-14	Preliminary datasheet
0.30	2023-03-02	Preliminary datasheet

Trademarks

All referenced product or service names and trademarks are the property of their respective owners.

Edition 2023-03-02

Published by

Infineon Technologies AG
81726 Munich, Germany

© 2023 Infineon Technologies AG
All Rights Reserved.

Do you have a question about any aspect of this document?

Email: erratum@infineon.com

Document reference
IFX-ABC637-003

Important notice

The information given in this document shall in no event be regarded as a guarantee of conditions or characteristics ("Beschaffheitsgarantie").

With respect to any examples, hints or any typical values stated herein and/or any information regarding the application of the product, Infineon Technologies hereby disclaims any and all warranties and liabilities of any kind, including without limitation warranties of non-infringement of intellectual property rights of any third party.

In addition, any information given in this document is subject to customer's compliance with its obligations stated in this document and any applicable legal requirements, norms and standards concerning customer's products and any use of the product of Infineon Technologies in customer's applications.

The data contained in this document is exclusively intended for technically trained staff. It is the responsibility of customer's technical departments to evaluate the suitability of the product for the intended

Warnings

Due to technical requirements products may contain dangerous substances. For information on the types in question please contact your nearest Infineon Technologies office.

Except as otherwise explicitly approved by Infineon Technologies in a written document signed by authorized representatives of Infineon Technologies, Infineon Technologies' products may not be used in any applications where a failure of the product or any consequences of the use thereof can reasonably be expected to result in personal injury.