



SPECIFICATION SHEET

SPECIFICATION SHEET NO.	Q0526- CR0201FM560KS1
DATE	May. 26, 2023
REVISION	A0
DESCRIPTION	<p>Thick Film Chip Resistors, 0201 (0603 Metric), CR01 Series, Dimension L0.60*W0.30*H0.23mm, 2 Terminations Tolerance: ±1%, Resistance 560K ohm, Dissipation Max. 1/20W @ 70°C Temperature Coefficient Rate (TCR) Max. ±200ppm/°C Operating Temp. Range -55°C ~+125°C Package in Tape/Reel, 15,000pcs/Reel RoHS/RoHS III compliant and HF</p>
CUSTOMER	
CUSTOMER PART NUMBER	
CROSS REF. PART NUMBER	
ORIGINAL PART NUMBER	Aillen CR01FM560K
PART CODE	CR0201FM560KS1

VENDOR APPROVE			
Issued/Checked/Approved			
DATE: May. 26, 2023			

CUSTOMER APPROVE	
DATE:	

5/26/2023

THICK FILM CHIP RESISTORS CR01 SERIES

DESCRIPTION

The resistors are constructed in a high grade ceramic body (aluminum oxide). Internal metal electrodes are added at each end and connected by a resistive paste that is applied to the top surface of the substrate. The composition of the paste is adjusted to give the approximate resistance required and the value is trimmed to within tolerance by laser cutting of this resistive layer. The resistive layer is covered with a protective coat. Finally, the two external end terminations are added. For ease of soldering the outer layer of these end terminations is a Tin (lead free) alloy.



MAIN FEATURE

- High Reliability And Stability
- Reduced Size Of Final Equipment
- Lower Assembly Costs
- Higher Component And Equipment Reliability
- RoHS III Compliant And Halogen Free Products

APPLICATION

- Consumer Electrical Equipment
- EDP, Computer Application
- Telecom Application

RFQ

[Request For Quotation](#)

PART CODE GUIDE

CR	0201	F	M	560K	S1
1	2	3	4	5	6

- 1) **CR**: Product code for Thick Film Chip Resistors
- 2) **0201**: Size Code, 0201 (0603 Metric), CR01 Series, Dimensions L0.60*W0.30*H0.23mm,
- 3) **F**: Resistance Range Tolerance Code, P: Jumper; B: +/-0.1%; D: +/-0.5%; F: +/-1%; J: +/-5%
- 4) **M**: Package Code, A: 4Kpcs/7"Reel; B:5kpcs/7"Reel; C:10kpcs/7"Reel; M:15kpcs/7"Reel; D:10kpcs/10"Reel; E:20kpcs/10"Reel
- 5) **560K**: Resistance value code. 0R: 0ohm; 1R2: 1.2ohm; 10R: 10ohm; 22R: 22ohm; 51R: 51ohm; 160R: 160ohm; 470R: 470ohm
1K: 1Kohm; 1K3: 1.3Kohm; 3K: 3.0Kohm; 18K: 18 Kohm; 20K: 20Kohm; 100K: 100Kohm; 560K: 560Kohm; 1M: 1.0Mohm; 3M: 3.0Mohm
- 6) **S1**: Internal control code, digits and letter; Blank: N/A

THICK FILM CHIP RESISTORS CR01 SERIES

DIMENSION (Unit: mm)

Image for reference



General Marking:
Blank

CR01 series

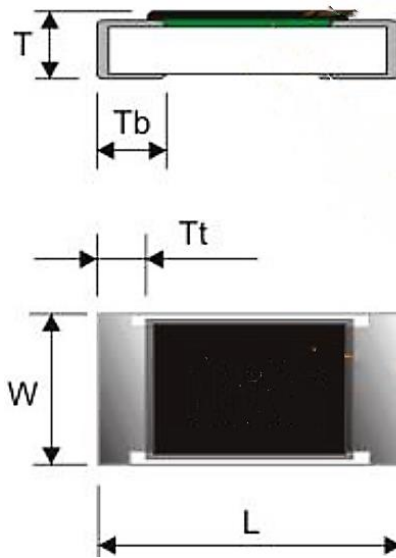

Item	Dimension
L	0.60±0.03
W	0.30±0.03
T	0.23±0.03
T b	0.15±0.05
T t	0.10±0.05

Resistors Construction For Reference

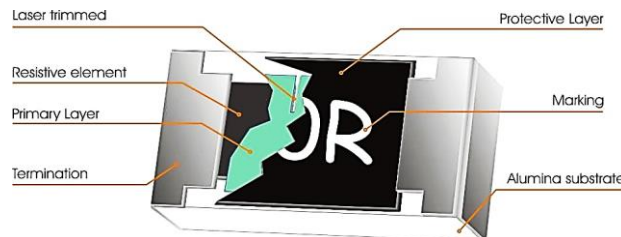

Recommended Solder Pad

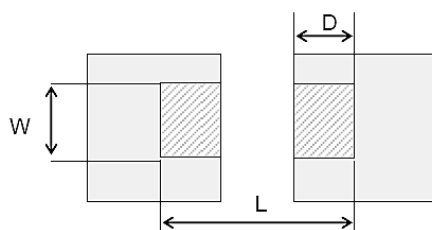

Item	Dimension (mm)
W	0.25~0.30
L	0.70~0.90
D	0.30~0.40

THICK FILM CHIP RESISTORS CR01 SERIES
GENERAL ELECTRONICAL CHARACTERISTICS

Item		Unit	Symbol	Characteristic	Condition
Product Name			CR	Thick Film Chip Resistors	
Size			0201	CR01 Series, L0.60*W0.30*H0.23mm	
Resistance Range		Ω		560K	
Resistance Tolerance		%	F	+/-1	
TCR	10Ω~10MΩ	ppm/°C		≤±200	
	1Ω~9.76Ω			-200~+600	
Max. Dissipation		W		1/20	@ Tamb=70°C
Operating Temperature		°C		-55 ~+125	
Max. Operation Voltage		V		25	@DC or RMS
Max. Overload Voltage		V		50	@DC or RMS

Note

- 1) This is the maximum voltage that may be continuously supplied to the resistor element, see "IEC publication 60115-8"
- 2) Max. Operation Voltage : So called RCWV (Rated Continuous Working Voltage) is determined by

$$RCWV = \sqrt{\text{Rated Power} \times \text{Resistance Value}}$$
or Max. RCWV listed above, whichever is lower.
- 3) Test condition for jumper (0 Ω)

Item	Unit	Symbol	Characteristic	Condition
Power Rating At 70°C	W		1/20	
Max. Resistance	mΩ		50	
Rated Current	A		1.0	
Peak Current	A		2.5	
Operating Temperature	°C		-55 ~+125	

THICK FILM CHIP RESISTORS CR01 SERIES

PRODUCT CHARACTERIZATION

Standard values of nominal resistance are taken from the E24 & E96 series for resistors with a tolerance of +/-1% & +/-5%, The values of the E24/E96 series are in accordance with "IEC publication 60063"

DERATING

The power that the resistor can dissipate depends on the operating temperature; see Fig.1

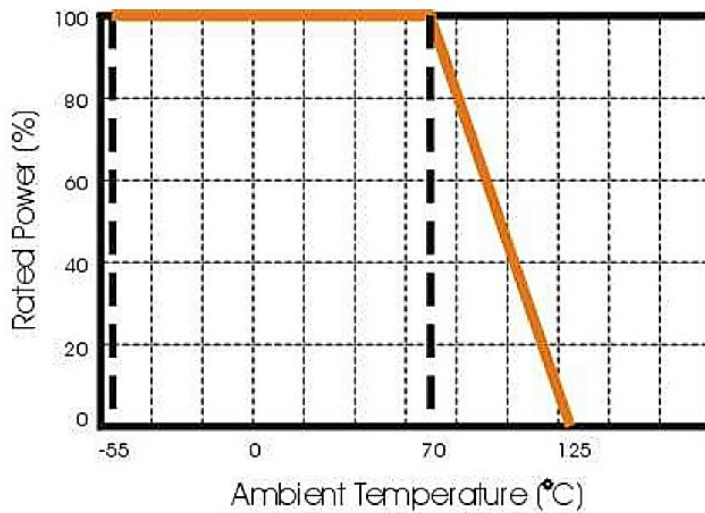

Fig 1 Maximum dissipation in percentage of rated power as a function of the ambient temperature for CR0402

MOUNTING

Due to their rectangular shapes and small tolerances, Surface Mountable Resistors are suitable for handling by automatic placement systems. Chip placement can be on ceramic substrates and printed-circuit boards (PCBs). Electrical connection to the circuit is by individual soldering condition. The end terminations guarantee a reliable contact.

THICK FILM CHIP RESISTORS CR01 SERIES

REFLOW SOLDERING CONDITION

The robust construction of chip resistors allows them to be completely immersed in a solder bath of 260 °C for 10 seconds. Therefore, it is possible to mount Surface Mount Resistors on one side of a PCB and other discrete components on the reverse (mixed PCBs). Surface Mount Resistors are tested for solderability at 235 °C during 2 seconds. The test condition for no leaching is 260°C for 30 seconds. Typical examples of soldering processes that provide reliable joints without any damage are given in Fig 2.

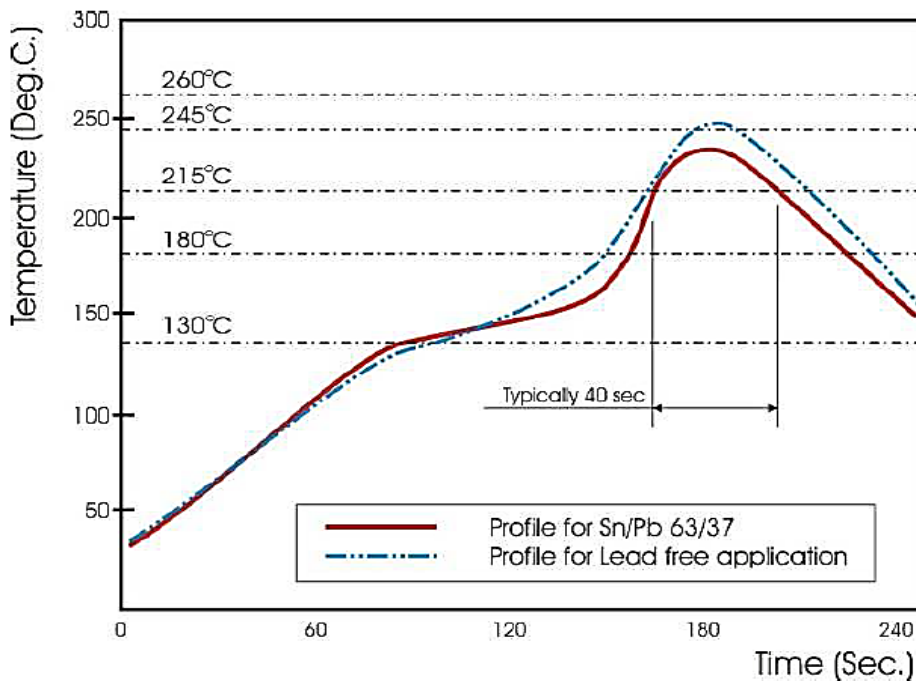

Fig 2. Infrared soldering profile for Chip Resistors

THICK FILM CHIP RESISTORS CR01 SERIES
TEST AND REQUIREMENT (JIS C 5201-1 : 1998)

TEST	PROCEDURE / TEST METHOD	REQUIREMENT	
		Resistor	0Ω
Electrical Characteristics JIS C 5201-1: 1998 Clause 4.8	- DC resistance values measurement - Temperature Coefficient of Resistance (T.C.R) Natural resistance change per change in degree centigrade. $\frac{R_2 - R_1}{R_1(t_2 - t_1)} \times 10^6 \text{ (ppm/}^\circ\text{C)}$ t1 : 20°C+5°C-1°C; t2 : -55°C or +125°C R1 : Resistance at reference temperature (20°C+5°C/- 1°C) R2: Resistance at test temperature (-55°C or +125°C)	Within the specified tolerance Refer to “QUICK REFERENCE DATA”	<50mΩ
Short time overload (S.T.O.L) Clause 4.13	Permanent resistance change after a 5second application of a voltage 2.5 times RCWV or the maximum overload voltage specified in the above list, whichever is less.	ΔR/R max. ±(2%+0.10Ω)	<50mΩ
Resistance to soldering heat(R.S.H) Clause 4.18	Un-mounted chips completely immersed for 10±1second in a SAC solder bath at 260°C±5°C	ΔR/R max. ± (1%+0.05Ω) no visible damage	<50mΩ
Solderability Clause 4.17	Un-mounted chips completely immersed for 2±0.8 second in a SAC solder bath at 235°C±5°C	95% coverage min., good tinning and no visible damage	
Temperature cycling Clause 4.19	30 minutes at -55°C±3°C, 2~3 minutes at 20°C+5°C-1°C, 30 minutes at +125°C±3°C, 2~3 minutes at 20°C+5°C1°C, total 5 continuous cycles	ΔR/R max. ±(1%+0.05Ω)	<50mΩ
Damp Heat (Load life in humidity) Clause 4.24	1000 +48/-0 hours, loaded with RCWV or Vmax in humidity chamber controller at 40°C±2°C and 90~95% relative humidity, 1.5hours on and 0.5 hours off	10Ω≤R<1MΩ : ΔR/R max. ±(3%+0.10Ω) R<10Ω, R≥1MΩ : ΔR/R max. ±(5%+0.10Ω)	<50mΩ

THICK FILM CHIP RESISTORS CR01 SERIES

TEST AND REQUIREMENT (JIS C 5201-1 : 1998)

TEST	PROCEDURE / TEST METHOD	REQUIREMENT	
		Resistor	0Ω
Load Life (Endurance) Clause 4.25	1000+48/-0 hours; loaded with RCWV or V max in chamber controller 70±2°C, 1.5 hours on and 0.5 hours off	Ditto.	
Bending strength Clause 4.33	Resistors mounted on a 90mm glass epoxy resin PCB(FR4), bending once 5mm for 10sec	No visual damaged, ΔR/R max. ±(1%+0.05Ω)	<50mΩ
Adhesion Clause 4.32	Pressurizing force: 3N, Test time: 10±1sec.	No remarkable damage or removal of the terminations	

STORAGE AND HANDLING CONDITIONS

- 1) Products are recommended to be used up within two years since operation date as ensured shelf life. Check solderability in case shelf life extension is needed.
- 2) To store products with following condition: Temperature : 5 to 40°C Humidity: 20 to 70% relative humidity
- 3) Don't store products in a corrosive environment such as sulfide, chloride gas, or acid. It may cause oxidization of electrode, which easily be resulted in poor soldering b.To store products on the shelf and avoid exposure to moisture. Don't expose products to excessive shock, vibration, direct sunlight and so on.

THICK FILM CHIP RESISTORS CR01 SERIES

REEL DIMENSION (Unit: mm)

7": 15,000Ppcs/Reel

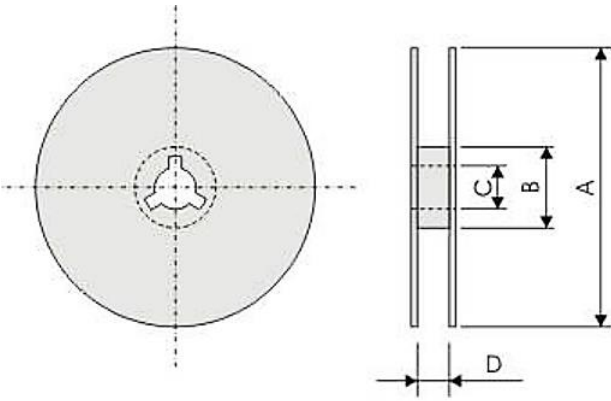

Code	Dimension 7"	Dimension 10"	Dimension 13"
A	178.0+/-2.0	254.0+/-2.0	330.0+/-2.0
B	60.0 +/-1.0	100 +/-1.0	100+/-1.0
C	13.0+/-0.20	13.0+/-0.20	13.0+/-0.20
T	9.0+/-0.50	9.0+/-0.5	9.0+/-0.5

TAPE DIMENSION (Unit: mm)

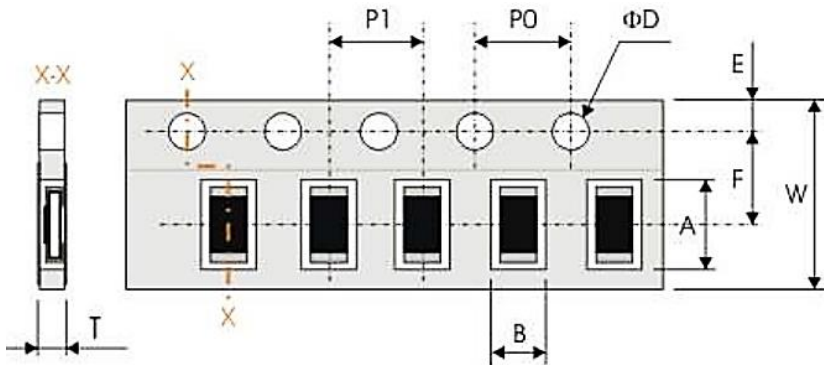

Code	Dimension
A	0.67±0.05
B	0.37±0.05
W	8.00±0.20
F	3.50±0.05
E	1.75±0.10
P 1	2.00±0.05
P0	4.00±0.05
ΦD	1.50±0.10
T	0.45±0.05

TAPING QUANTITY AND TAPE MATERIAL

Tape	Paper Tape						Embossed Tape	Bulk Cassette
	4 mm Pitch			2 mm Pitch			4 mm Pitch	
Reel Size	7"	10"	13"	7"	10"	13"	7"	
CR01	-	-	-	15000pcs	-	-	-	-

THICK FILM CHIP RESISTORS CR01 SERIES

PERFORMANCE OF TAPING

Strength of Carrier Tape and Top Cover Tape

Carrier Tape: When a tensile force 1.02kgf is applied in the direction of unreeling the tape, the tape shall withstand this force. Top cover Tape: When a tensile force 1.02kgf is applied to the tape, the tape shall withstand this force.

Peel Force of Top Cover Tape

Unless otherwise specified, the peel force of top cover tape shall be 10.2 to 71.4 g f when the top cover tape is pulled at a speed of 300mm/min with the angle between the taped during peel and the direction of unreeling maintained at 165 to 180° as illustrated in Fig.

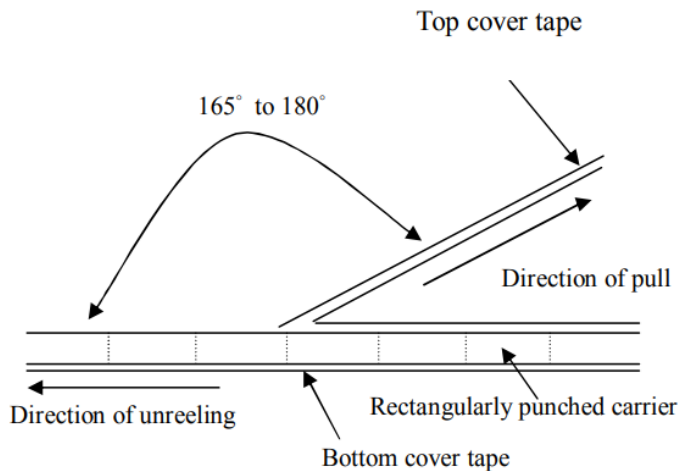

DISCLAIMER

NextGen Component, Inc. reserves the right to make changes to the product(s) and or information contained herein without notice. No liability is assumed as a result of their use or application. No rights under any patent accompany the sale of any such product(s) or information