

OTe 13/220...240/350 PC

OPTOTRONIC Phase-cut OTE | Compact constant current LED driver – Dimmable



Product family features

- Dimmable via leading edge/trailing edge
- Type of protection: IP20

Product family benefits

- Compact housing for mounting in very tight spaces
- Compatible with the most common leading-edge and trailing-edge phase dimmers

Areas of application

- Optional cable clamp E-style for independent mounting
- Suitable for indoor installations
- Suitable for indoor SELV installations

Technical data

Electrical data

Nominal input voltage	220...240 V
Mains frequency	50/60 Hz
Input voltage AC	198...264 V ¹⁾
Total harmonic distortion	< 20 %
Power factor λ	0.95/0.90 ²⁾
Efficiency in full-load	84 % ³⁾
Device power loss	2.6 W ⁴⁾
Inrush current	5 A ⁵⁾
Max. ECG no. on circuit breaker 10 A (B)	82
Max. ECG no. on circuit breaker 16 A (B)	130
Max. ECG no. on circuit breaker 25 A (B)	-
Surge capability (L/N-Ground)	1 kV
Surge capability (L-N)	1 kV
Nominal output voltage	18...38 V ⁶⁾
U-OUT (working voltage)	50 V
Nominal output current	350 mA ⁷⁾
Output current tolerance	±10 %
Output ripple current (100 Hz)	25 % ⁸⁾
Output PSTLM	≤1
Output SVM	≤0.6
Nominal output power	13 W ⁹⁾
Maximum output power	13 W
Galvanic isolation primary/secondary	SELV
Current set	Fixed current

¹⁾ Permitted voltage range

²⁾ Full load at 230 V/Minimum load at 230 V

³⁾ at 230 V, 50 Hz

⁴⁾ Maximum

⁵⁾ $t_{width} = 100 \mu s$ (measured at 50 % I_{peak})

⁶⁾ Maximum <48 V

⁷⁾ ±10%

⁸⁾ Typical

⁹⁾ Partial load 6.5...13.5 W

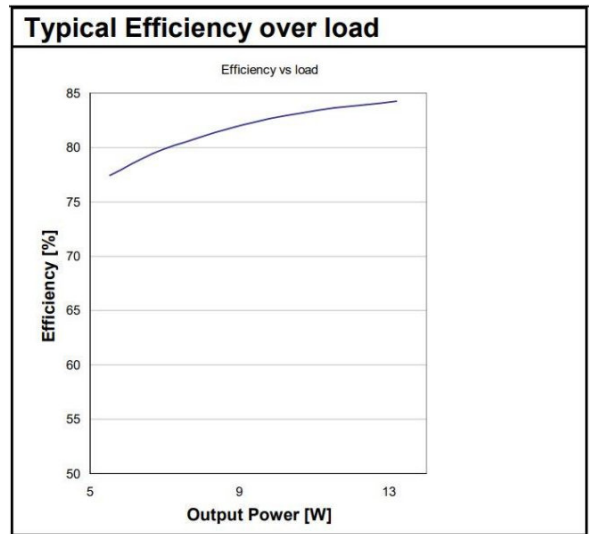
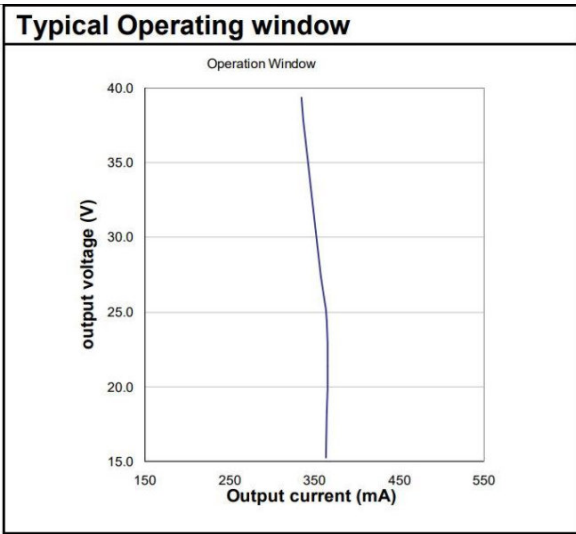

OTE 13220-240350 PC Operating Window

OTE 13220-240350 PC Typical Efficiency vs. Load (230 V 50 Hz)

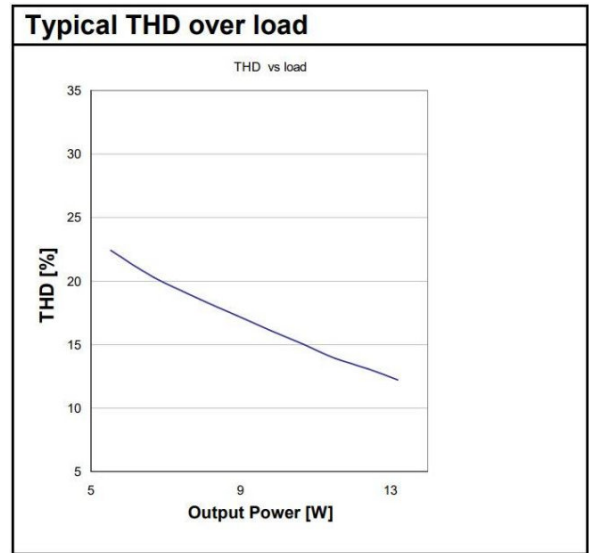
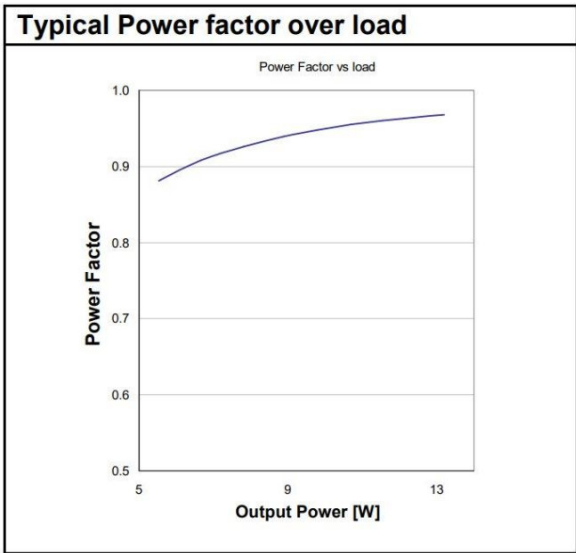

OTE 13220-240350 PC Typical Power Factor vs. Load

OTE 13220-240350 PC Typical THD Vs Load

Dimensions & weight

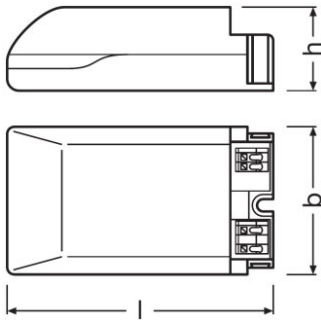

Mounting hole spacing, length	-
Mounting hole spacing, width	-
Product weight	81.00 g
Cable cross-section, input side	0.75...1.5 mm ² ¹⁾
Cable cross-section, output side	0.5...1.5 mm ² ¹⁾
Wire preparation length, input side	8.0...9.0 mm
Wire preparation length, output side	8.0...9.0 mm
Length	95.0 mm
Width	53.0 mm
Height	25.0 mm

¹⁾ Flexible / Solid leads

Colors & materials

Casing material	Plastic
-----------------	---------

Temperatures & operating conditions

Ambient temperature range	-20...+55 °C
Maximum temperature at tc test point	85 °C ¹⁾
Max.housing temperature in case of fault	110 °C
Temperature range at storage	-25...75 °C
Permitted rel. humidity during operation	5...85 % ²⁾

¹⁾ Maximum at the T_c-point

²⁾ Maximum 56 days/year at 85 %

Lifespan

ECG lifetime	50000 h ¹⁾
--------------	-----------------------

¹⁾ At $T_{case} = 75 °C$ at T_c point / 10% failure rate

Capabilities

Dimmable	Yes
Dimming interface	Phase Cut ¹⁾
Dimming range	10...100 %
Dimming method	Amplitude Modulation
Overheating protection	Automatic reversible
Overload protection	Automatic reversible
Short-circuit protection	Automatic reversible
No-load proof	Yes
Intended for no-load operation	No
Max. cable length to lamp/LED module	2.0 m ²⁾
Suitable for fixtures with prot. class	I / II
Type of connection, output side	Push terminal
Suitable for through-wiring	No

¹⁾ Leading edge / Trailing edge

²⁾ Output wires must be routed as close as possible to each other

Certificates & standards

Approval marks – approval	CE / ENEC 10 / VDE / CB
Standards	Acc. to IEC 61347-1/Acc. to IEC 61347-2-13/Acc. to IEC 62384/Acc. to CISPR 15/Acc. to IEC 61000-3-2/Acc. to IEC 61000-3-3/Acc. to IEC 61547
Protection class	II
Type of protection	IP20

Logistical data











Commodity code	850440829000
-----------------------	--------------

Environmental information

Information according Art. 33 of EU Regulation (EC) 1907/2006 (REACH)	
Date of Declaration	21-09-2022
Primary Article Identifier	4052899105324
Candidate List Substance 1	Lead
CAS No. of substance 1	7439-92-1
Safe Use Instruction	The identification of the Candidate List substance is sufficient to allow safe use of the article.
Declaration No. in SCIP database	ebf9463b-dcd2-41f6-a302-059f0363eca7

Product datasheet

Download Data

File	
	Certificates OT EMC 40038482 220421
	Certificates OT ENEC 40038447 130722
	Certificates 496535_CB report OTe 10 700 PC and OTe 13 350 PC
	Declarations of conformity OTe PC UK DoC 4281102 220322
	Declarations of conformity OTE PC CE 3365230 220322
	Installation/Operation notice OT PC dimmer list (EN)
	Installation guide 501497_OTe 13220-240350 PC
	CAD data 3-dim 377012_OTe 10-13 PC -cable clamp
	CAD data 3-dim 377013_OTe 10-13 PC -housing
	CAD data 3-dim 377014_OTe 10-13 PC -housing with cable clamp

Ecodesign regulation information:

Intended for use with LED modules.

The forward voltage of the LED light source shall be within the defined operating window of the control gear in all operating conditions including dimming if applicable.

Separate control gear and light sources must be disposed of at certified disposal companies in accordance with Directive 2012/19/EU (WEEE) in the EU and with Waste Electrical and Electronic Equipment (WEEE) Regulations 2013 in the UK. For this purpose, collection points for recycling centres and take-back systems (CRSO) are available from retailers or private disposal companies, which accept separate control gear and light sources free of charge. In this way, raw materials are conserved and materials are recycled.

Logistical Data

Product code	Product description	Packaging unit (Pieces/Unit)	Dimensions (length x width x height)	Volume	Gross weight
4052899105324	OTe 13/220...240/350 PC	Shipping carton box 20	284 mm x 207 mm x 96 mm	5.64 dm ³	1890.00 g

Product datasheet

Logistical Data

The mentioned product code describes the smallest quantity unit which can be ordered. One shipping unit can contain one or more single products. When placing an order, for the quantity please enter single or multiples of a shipping unit.

Accessories Optional

Product description	Accessory name	Accessory code
OTe 13/220...240/350 PC	OT CABLE CLAMP E-STYLE	▶ 4052899167896

Disclaimer

Subject to change without notice. Errors and omission excepted. Always make sure to use the most recent release.