

Relais Statique Triphasé

Three Phase Solid State Relays

Entraxe 47,5mm /47.5mm mounting

SGT769390E

Output 24 to 520 VAC
3 x 125 ARMS
Input 4-32VDC

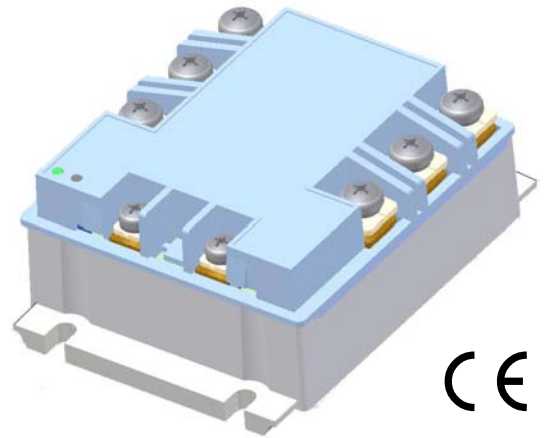

- ❑ Relais statique asynchrone Triphasé adapté à tout type de charge.
Three phase RANDOM Solid State Relay designed for all types of loads.
- ❑ Sortie thyristors hautes performances technologie TMS² (*) permettant une longue durée de vie : **24 à 600VAC 125A.**
(limité par la connectique et la thermique à 3 x50A (voir 75A)
Back to back thyristors on output with TMS² technology() for a long lifetime expectancy: 24 to 600VAC 125A (limitation by terminals and heatsinks at 50A or 75A*
- ❑ Tension de commande 4 - 32VDC entrée courant régulé
LED de visualisation sur l'entrée de couleur verte.
*Control range: 4-32VDCwith current regulation.
Green LED visualization on the input.*

Application typique

Typical application:

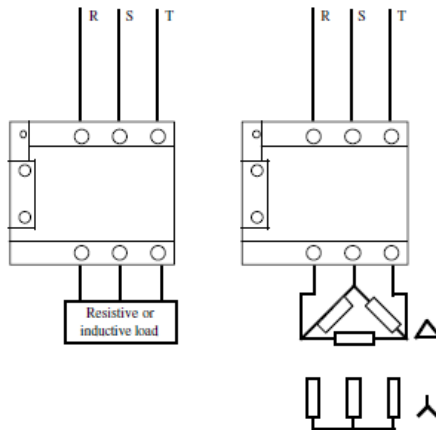

Circuit équivalent/Equivalent circuit :

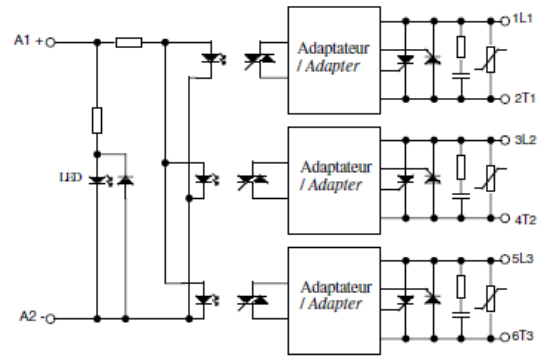

Caractéristiques de commande (à 20°C) / Control characteristics (at 20°C)

Paramètre / Parameter	Symbol	DC			Unit
		Min	Nom	Max	
Tension de commande / Control voltage	Uc	4		32	V
Courant de commande / Control current (@ Uc)	Ic		<25		mA
Tension de relachement/Release voltage	Uc off	2			V
Résistance interne / Input internal resistor fig.1	Rc	Current regulator			Ω
Tension inverse / Reverse voltage	Urv		30		V

Caractéristiques d'entrée-sortie (à 20°C) / Input-output characteristics (at 20°C)

Isolement entrée-sortie/Input-output isolation @500m	Ui		4000		VRMS
Isolement sortie-semelle/Output-case isolation @500m	Ui		3300		VRMS
Tension assignée isolement/ Rated impulse voltage	Uimp		4000		V

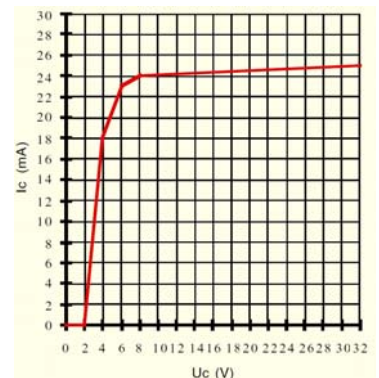

Caractéristiques générales / General characteristics

Paramètre / Parameter	Conditions	Symbol	Typ.	Unit
Poids/Weight			370	g
Plage de température de stockage / Storage temperature range			-40 / +100	°C
Plage de température de fonctionnement/Operating temperature range			-40 / +100	°C

Proud to serve you

All technical characteristics are subject to change without previous notice.
Caractéristiques sujettes à modifications sans préavis.

Caractéristiques de sortie / Output characteristics (at 25°C)

Paramètre / Parameter	Conditions	Symbol	Min	Typ.	Max	Unit
Plage de tension utilisation / Operating voltage range		Ue	24	400	520	V rms
Tension de crête / Peak voltage		Up	1200 (varistor clamps 950V)			V
Niveau de synchronisme / Zero cross level		U _{sync}		Random		V
Tension minimum amorçage / Latching voltage	Ie nom	Ua	10			V
Courant nominal / nominal current (AC-51)		Ie AC-51		50	75 (125)	A rms
Courant surcharge / Non repetitive overload current	tp=10ms (Fig. 3)	I _{tsm}	2000	2100		A
Chute directe à l'état passant / On state voltage drop	@ 25°C	Vt			0,9	V
Résistance dynamique / On state dynamic resistance		rt			4,8	mΩ
Puissance dissipée (max) / Output power dissipation (max value)		Pd	(0,9x0,9xIe + 0,0048 x Ie ²)x3			W
Résistance thermique jonction/semelle / Thermal resistance between junction to case		R _{thj/c}		0,4		K/W
Courant de fuite à l'état bloqué / Off state leakage current	@Ue typ, 50Hz	I _{lk}			2	mA
Courant de fuite à l'état bloqué / Off state leakage current	@Ue typ, 400Hz	I _{lk}			10	mA
Courant minimum de charge / Minimum load current		I _{emin}	5			mA
Temps de fermeture / Turn on time	@Ue typ, 50Hz	ton max			30	ms
Temps d'ouverture / Turn off time	@Ue typ, 50Hz	toff max			30	ms
Fréquence utilisation / Operating frequency range	F mains	f	0,1	50-60	400	Hz
dv/dt à l'état bloqué / Off state dv/dt		dv/dt	500			V/μs
di/dt max / Maximum di/dt non repetitive		di/dt			50	A/μs
I _{zt} (<10ms)		I ² t	20000	22000		A ² s
Immunité / Conducted immunity level	IEC/EN61000-4-4 (bursts)		2kV criterion B			
Immunité / Conducted immunity level	IEC/EN61000-4-5 (surge)		2kV criterion A with external VDR			
Protection court-circuit / Short circuit protection	Type 2	Example	Fuse MERSEN gRC40A			

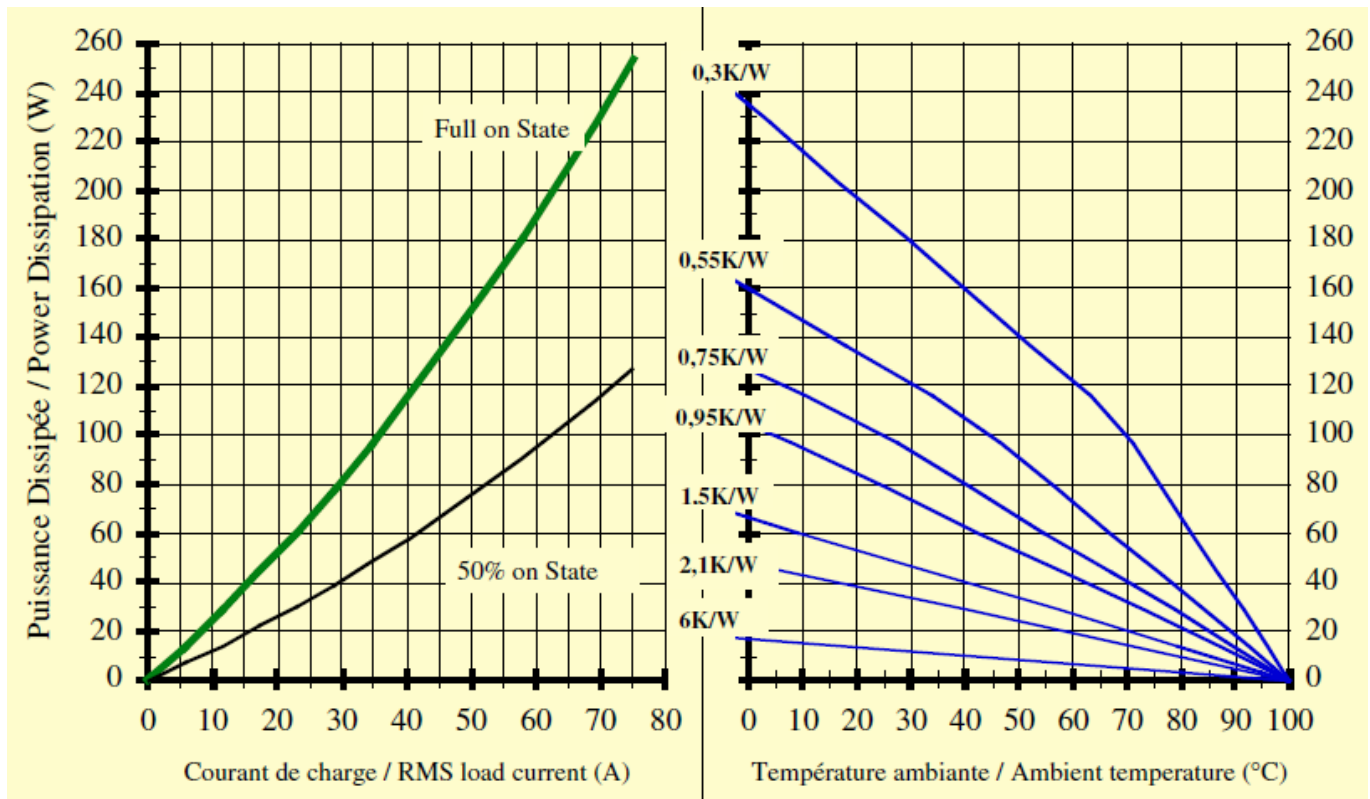
Caractéristiques thermiques / thermal curves :

celduc®
r e l a i s

www.celduc.com

5 Rue Ampère B.P. 30004

42290 SORBIERS - FRANCE

E-Mail : celduc-

relais@celduc.com

Fax +33 (0) 4 77 53 85 51

Service Commercial France Tél. : +33 (0) 4 77 53 90 20

Sales Dept.For Europe Tel. : +33 (0) 4 77 53 90 21

Sales Dept. Asia : Tél. +33 (0) 4 77 53

90 19

fig 3 : Courants de surcharges / *Overload currents*

1 - *I_{tsm}* non répétitif sans tension réappliquée est donné pour la détermination des protections.

1 - *No repetitive I_{tsm} is given without voltage reapplied. This curve is used to define the protection (fuses).*

2 - *I_{tsm}* répétitif est donné pour des surcharges de courant (T_j initiale=70°C).

Attention : la répétition de ces surcharges de courant diminue la durée de vie du relais.

2 - *Repetitive I_{tsm} is given for inrush current with initial $T_j = 70^\circ\text{C}$. In normal operation, this curve mustn't be exceeded.*

Be careful, the repetition of the surge current decreases the life expectancy of the SSR.

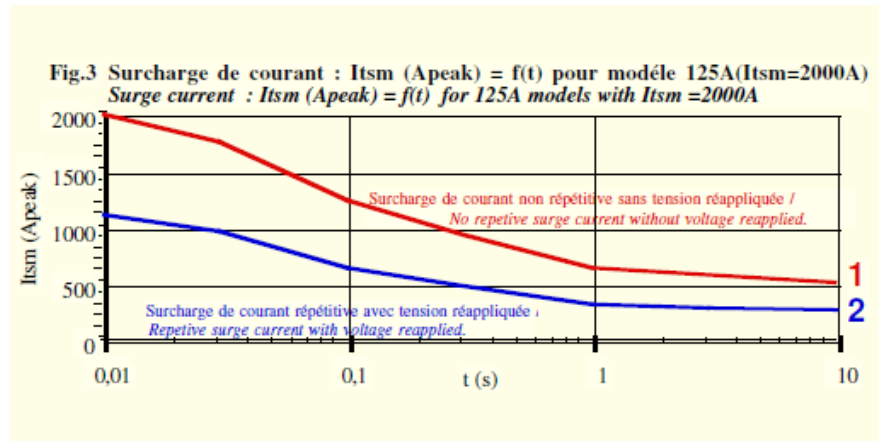

-> **Attention !** les relais à semi-conducteurs ne procurent pas d'isolation galvanique entre le réseau et la charge. Ils doivent être utilisés associés à un disjoncteur avec propriété de sectionnement ou similaire, afin d'assurer un sectionnement fiable en amont de la ligne dans l'hypothèse d'une défaillance et pour tous les cas où le relais doit être isolé du réseau (maintenance ; non utilisation sur une longue durée...).

-> **Warning !** semiconductor relays don't provide any galvanic insulation between the load and the mains. Always use in conjunction with an adapted circuit breaker with isolation feature or a similar device in order to ensure a reliable insulation in the event of wrong function and when the relay must be insulated from the mains (maintenance ; if not used for a long duration ...).

Dimensions

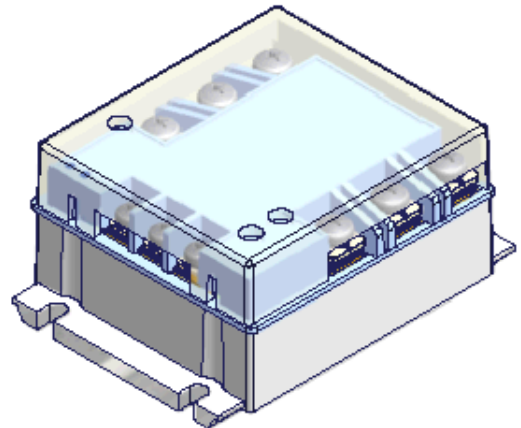
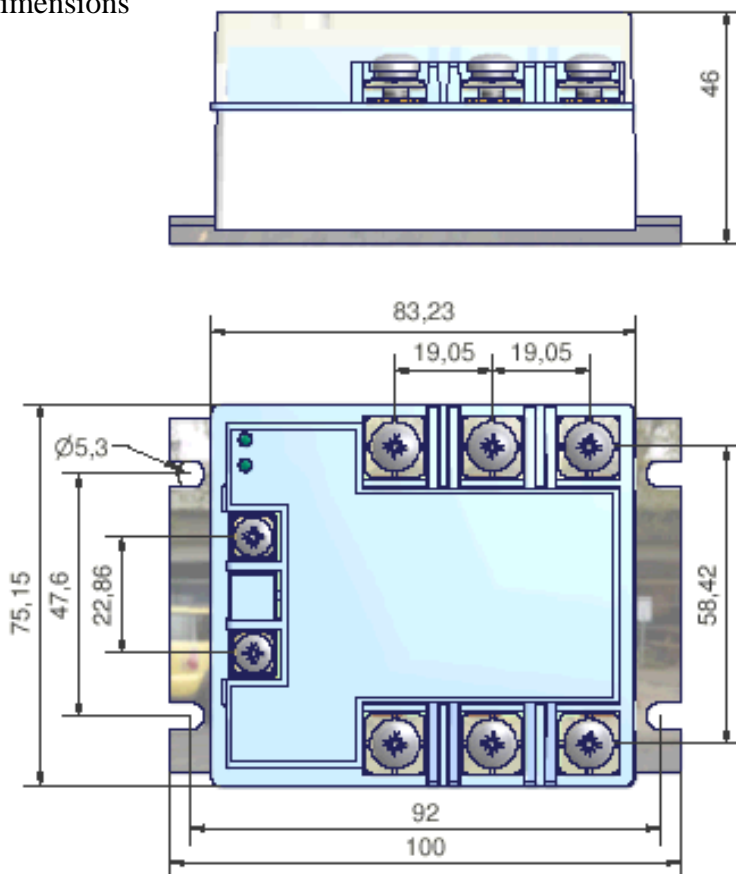

avec capot 1K199000

with transparent cover 1K199000

TERMINALS

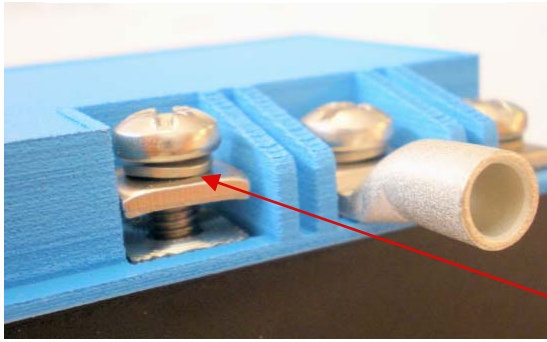









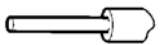

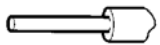
M5 power connection

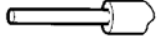

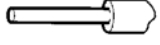
M4 control connection

Nouvelles bornes avec rondelles freins
New terminals with washers

SGT HE					Raccordement d'entrée / Control wiring	
Nombre de fils / Number of wires				Modèle de tournevis / Screwdriver type	Couple de serrage recommandé Recommended Torque	
1		2				
Fil rigide (sans embout) SOLID (No ferrule)	Fil multibrins (avec embout) FINE STRANDED (With ferrule)	Fil rigide (sans embout) SOLID (No ferrule)	Fil multibrins (avec embout) FINE STRANDED (With ferrule)		M4	
					N.m	
0,75 ... 2,5 mm ² AWG18...AWG14	0,75 ... 2,5 mm ² AWG18...AWG14	0,75 ... 2,5 mm ² AWG18...AWG14	0,75 ... 2,5 mm ² AWG18...AWG14	POZIDRIV 2	1,2	
okpac®					Raccordement de puissance / Power wiring	
Nombre de fils / Number of wires				Modèle de tournevis / Screwdriver type	Couple de serrage recommandé Recommended Torque	
1		2				
Fil rigide (sans embout) SOLID (No ferrule)	Fil multibrins (avec embout) FINE STRANDED (With ferrule)	Fil rigide (sans embout) SOLID (No ferrule)	Fil multibrins (avec embout) FINE STRANDED (With ferrule)		M5	
					N.m	
1,5 ... 10 mm ² AWG16...AWG8	1,5 ... 6 mm ² AWG16...AWG10	1,5 ... 10 mm ² AWG16...AWG8	1,5 ... 6 mm ² AWG16...AWG10	POZIDRIV 2	2	
Puissance avec cosses / Power with ring terminals.						
  		W max = 12,6mm 16 mm ² (AWG6) 25 mm ² (AWG4) 35mm ² (AWG2 /AWG3) 50mm ² (AWG0 /AWG1)				

celduc®

r e l a i s

www.celduc.com



5 Rue Ampère B.P. 30004

42290 SORBIERS - FRANCE

E-Mail : celduc-

relais@celduc.com

Fax +33 (0) 4 77 53 85 51

Service Commercial France Tél. : +33 (0) 4 77 53 90 20

Sales Dept. For Europe Tel. : +33 (0) 4 77 53 90 21

Sales Dept. Asia : Tél. +33 (0) 4 77 53

90 19