

**SPECIFICATION SHEET**

<b>SPECIFICATION SHEET NO.</b>	Q0120- YG10M00000S418
<b>DATE</b>	Jan. 20, 2023
<b>REVISION</b>	A0
<b>DESCRIPTION</b>	MHz Plastic SMD Crystals, L8.0*W3.8*H2.5mm, 4 Pads, CCMD series 10.000MHz, Tolerance +/-20ppm, Load Capacitor 18pF, Frequency stability +/-30ppm @Operating Temp. Range -40°C ~+85°C, ESR 150 ohm Max, Reflow Profile Condition 260 °C Max. Tape/Reel, 3000pcs/Reel RoHS/RoHS III compliant, RoHS Annex III lead Exemption (exempt per RoHS EU 2015/863)
<b>CUSTOMER</b>	
<b>CUSTOMER PART NUMBER</b>	
<b>CROSS REF. PART NUMBER</b>	
<b>ORIGINAL PART NUMBER</b>	TGS CCMD 10M0A20-18-30-40-150TLH
<b>PART CODE</b>	YG10M00000S418

**VENDOR APPROVE**

Issued/Checked/Approved



DATE: Jan. 20, 2023

**CUSTOMER APPROVE**

DATE:

1/20/2023

**MHZ PLASTIC SMD CRYSTALS 8038 TYPE CCMD SERIES**

**MAIN FEATURE**

- SMD Package, 8038 Type, L8.0\*W3.8\*H2.5mm, 4 Pads
- Low cost and short lead time
- Industry standard
- Reflow Profile Condition 260 °C Max.
- Cross more competitors part
- RoHS/RoHS III compliant, RoHS Annex III lead Exemption (exempt per RoHS EU 2015/863)



**APPLICATION**

- Clock source for Portable
- Microcomputer & Automotive Equipment with Low power consumption

**PART CODE GUIDE**

**RFQ**

[Request For Quotation](#)

YG	10M00000	S	418
1	2	3	4

- 1) YG: Part family Code for MHz Plastic SMD Crystals, L8.0\*W3.8\*H2.5mm, 4 Pads, CCMD series
- 2) 10M00000: Frequency range code for 10.000MHz
- 3) S: SMD type, Package Tape/Reel, 3000pcs/Reel
- 4) 418: Specification code for original part No.: **TGS CCMD 10M0A20-18-30-40-150TLH**

**MHZ PLASTIC SMD CRYSTALS 8038 TYPE CCMD SERIES**

**DIMENSION (Unit: Inch/mm)**

Image for reference



CCMD



Marking  
Frequency Range

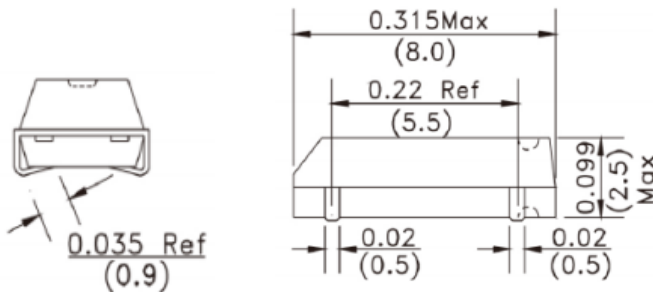
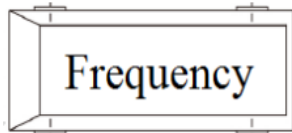

**Note:**

- Do not connect pad 2 and Pad 3 to external devices.
- Metal inside may be exposed on the top or bottom of plastic case
- It isn't Quality problem. This will not affect any quality, reliability and electrical specification when used

**Recommend Pad Layout**

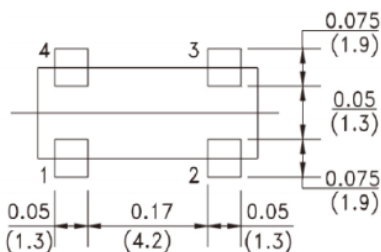

**Electrode Arrangement**



**Pin Function**

- #1 Crystal
- #2 Ground
- #3 Ground
- #4 Crystal

**MHZ PLASTIC SMD CRYSTALS 8038 TYPE CCMD SERIES**
**ELECTRICAL PARAMETERS**

Parameter	Part No. Symbol	Units	Value			Condition
			Min.	Typical	Max.	
Original Manufacturer	TGS	TGS Crystals				
Holder Type	CCMD	MHz SMD Crystal, Plastic case, L8.0*W3.8*H2.5mm				
Frequency Range	10M0	MHz	10.0000			
Mode of Oscillation	A	AT Fundamental				
Frequency Tolerance	20	ppm	-20		+20	@25°C
Load Capacitance	-18	pF	18			
Stability over Operation Temperature	-30	ppm	-30		+30	
Operation Temperature	-40	°C	-40		+85	
Storage Temperature		°C	-55		+125	
Equivalent Series Resistance (ESR)	-150	Ω			150	
Drive Level		μW			100	
Shunt Capacitance (C0)		pF	0		7.0	
Motional Capacitance (C1)		fF	N/A			
DLD2		Ω	N/A			
FLD2		ppm	N/A			
RDL2		Ω	N/A			
SPDB		dB	N/A			
Aging		ppm/year			±5	@1 <sup>st</sup> year
Insulation Resistance		MΩ	500			@100Vdc ± 15Vdc
Others	Package	T	Tape/Reel			
	RoHS Status	LH	RoHS III compliant, RoHS Annex III lead Exemption (exempt per RoHS EU 2015/863)			
	Add Value		N/A			
	Code *		Internal Control or N/A			

Note: 1) Original Part Number: **TGS CCMD 10M0A20-18-30-40-150TLH**

2) \* Internal Control Code- 2 letter or digits; Blank: N/A

**MHZ PLASTIC SMD CRYSTALS 8038 TYPE CCMD SERIES**

**TEST STANDARD**

**General Electrical Characteristics And Visual testing**

1. LOT CLASSIFICATION : If The Quantity Is 1000 PCS Or More, 1000 PCS Is One Lot
  2. Sampling Test Method : Mil-std-105e G-ii
  3. Test Level
    - A) High Level Defect : AQL 0.065% [200 Pcs]
    - B) Medium Level Defect : AQL 0.25% [50 Pcs]
    - C) Low Level Defect : AQL 0.4% [32 Pcs]
  4. Defect Classification:
    - A) High Level: @No Frequency; @Mixing; @Leak Defect
    - B) Medium Level - Electrical Characteristic Defect :
      - @Frequency; @Oscillation; @Electrical Current; @Other Electrical Characteristics Defect
    - C) Visual : @Marking; @Welding; @Leads ; @Other Visual Defect
- Testing Method And Its Standard Can Be Modified Depending On The Customer's Request

**EQUIVALENT CIRCUITS**

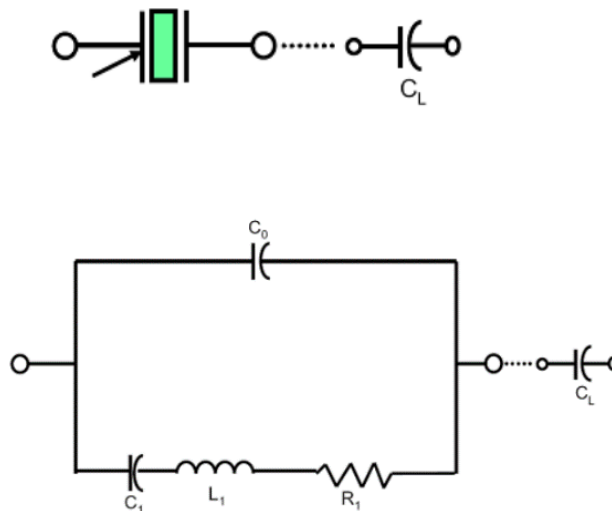

Symbol for crystal unit

## MHZ PLASTIC SMD CRYSTALS 8038 TYPE CCMD SERIES

### CHARACTERISTICS

Units and values indicated with { } in this specification are the former units and the specified values.

#### **Standard Atmospheric Conditions:**

Unless otherwise specified the standard range of atmospheric conditions for making measurements and tests is as follows:

Ambient temperature: 15°C to 35°C;

Relative humidity : 25% to 85%;

Air pressure: 86 to 106 k Pa

If there is any doubt about the results measurements shall be made within the following limits:

Ambient temperature : 25±1°C;

Relative humidity : 63% to 67% ;

Air pressure : 86 to 106 k Pa

#### **Operating Temperature Range:**

The operating temperature range is the range of ambient temperatures at which the quartz crystal oscillator can be stored without damage. Conditions are as specified elsewhere on these specifications.

Operating temperature range: -40°C to +85°C

#### **Storage Temperature Range:**

The storage temperature range is the range of ambient temperatures at which the quartz crystal oscillator can be stored without damage. Conditions are as specified elsewhere on these specifications.

Storage temperature range: -55°C to +125°C

## MHZ PLASTIC SMD CRYSTALS 8038 TYPE CCMD SERIES

### **CAUTION**

\* In Order To Maintain Quality. Without Change In Characteristics Of The crystal Units. Please Follow Below Recommendation

#### **Shock**

All Crystal Units Have A Thin Crystal Blanks Within If It Is Dropped Above The Recommended Dropping Height (500mm) The Specific Characteristics And Appearance Can Be Changed Please Pay Special Attention To External Shock

#### **Environmental**

- 1) Crystal Units' Frequency Can Be Changed Due To Surrounding Temperature If It Is Stored Next To A High Temperature Heter (Above+85'c) Or Below 40'c.And A Strong Light Source For Long Period Of Time. The Electrical Characteristics Can Be Changed It Is Suggested That These Environment Be Avoided
- 2) If The Unit Is Placed In A Humid Environment. Lead Terminal Can Be Damaged: Therefore. Do Not Store The Crystal Units In A Humid Environment
- 3) Crystal unit Has Vibrating Characteristics If It Is Placed Where Vibration Exists The Operating Characteristics Can Be Altered; Therefore This Environment Should Be Avoided

#### **Leads**

- 1) After Soldering Crystal Units Into A PCB Impacting The Unit From The top, bottom Left Or Right Side Of The Unit Can Shatter The Glass Portion Of The Base Aendering The Unit Useless

#### **Assembly Method**

- 1) Correct Ultrasonic Frequency For Cleaning Should Be Less Than 20khz
- 2) SOLDERING SHOULD BE BONE USING IEC 61760-1 OR Pb-free Products

#### **Storage**

5.5.1 If The Crystal Units Are Stored In Humid Or Salty Environment Appearance Can Be Changed And Solderability Can Deteriorate; Therefore avoid Storing In Such Environment Do Not Store The Crystal Unit More Than 3 Months

**MHZ PLASTIC SMD CRYSTALS 8038 TYPE CCMD SERIES**

**RELIABILITY(MECHANICAL AND ENVIRONMENTAL ENDURANCE)**

TEST ITEMS	TEST METHOD AND CONDITIONS	REQUIREMENTS
<b>Vibration</b>	(1) Vibration Frequency: 10 To 55hz (2) Vibration Amplitude: 1.5mm (3) Cycle Time: 1~2min(10-55-10hz) (4) Direction: X.Y.Z (5) Duration: 2h/Each Direction (6) G-force: ≥5g	Frequency Change: ±10ppm Max. Resistance Change: ± 15% RRMax
<b>SHOCK</b>	3 Times Free Drop From 75cm Height To Hard Wooden Board Of Thickness More Than 30mm.	Frequency Change: ±10ppm Max. Resistance Change: ± 15% RRMax.
<b>LEAKAGE</b>	Put Crystal Units Into A Hermetic Container And Helium For 0.5-0.6. MPA and Keep It For 1h;check The Leakage By A Helium Leak Detector.	Leakage:1x10 <sup>-8</sup> mbar.L/S Max.
<b>SOLDERABILITY</b>	(1) Dip The Leads Into Flu X (ROJIN Methanol) For 3~5s. (2) Dip The Leads Into 245±5°C 99% Sn Dipping Solution For 5s.	The Dipped Part Of The Leads Should Have 95% SN Coating.
<b>SOLDERING HEAT RESISISTANCE TEST</b>	(1) Perform Electrical Characteristics Test Before Starting This Procedure. (2) Dip The Leads Into Flux(rojin Methanol) 5±0.5s. (3) Dip The Leads Into 260±5°C 99% Sn Dipping Solution For 5s. (4) Take The Unit Out ,Store At Room Temper For 30s Then Measure The Electrical Characteristics.	Should Pass Sealing And Visual Test. Frequency Change: ±10ppm Max.
<b>LEAK TEST</b>	Use Helium Leak Detector. Bombing Pressure:5kg/Cm <sup>2</sup> Bombing Time: 2 Hours Leak Should Be Less Than 1e-8 Atm. Cc/Sec.	Gas Or Air Should Not Be Detected.



**MHZ PLASTIC SMD CRYSTALS 8038 TYPE CCMD SERIES**

**RELIABILITY(MECHANICAL AND ENVIRONMENTAL ENDURANCE)**

Test Items	Test Method And Conditions	Requirements
<b>HIGH TEMPERATURE ENDURANCE</b>	The Crystal Units Shall Be Put In Somewhere For 500 Hours At Temperature Of 125°C ±5°C ,Then Keep It For 1 To 2 Hours Under Room Temperature.	Frequency Change: ±10ppm Max. Resistance Change: ± 15%rrmax.
<b>LOW TEMPERATURE ENDURANCE</b>	The Crystal Units Shall Be Put In Somewhere For 500 Hours At Temperature Of -40°C ,Then Keep It For 1 To 2 Hours Under Room.	Frequency Change: ±10ppm Max. Resistance Change: ± 15% RRMax
<b>HUMIDITY ENDURANCE</b>	Somewhere At 40°C ±5°C In Relative Humidity Of 90%~95% For 72 Hours, Then Keep It For One Or Two Hours Under Room Temperature	Frequency Change: ±10ppm Max. Resistance Change: ± 15% RRMax
<b>TEMPERATURE CYCLE</b>	Temperature Shift From Low(-40°C ) To High(100°C,keep 30 Minutes),satisfy High(100°C ) To Low(-40°C ,Keep 30 Minutes),then Go Up To Room Temperature For 10 Cycles.	Frequency Change: ±10ppm Max. Resistance Change: ± 15% RRMax
<b>LEAD TENSILTY</b>	(1) Fix The Unit. (2) Apply 2lb Of Weight Axis To The Leads. (3) Time:5s	Should Pass Sealing And Visual Test.
<b>LEAD BENDING</b>	(1) Attach 1lb Of Weight To Each Of The Leads. (2) Bending Angle:90°(from The Nomal Position To 45°oppostte Direction) (3) Bending Time:3s(each Direction) Number Of Bending:2times (4) Number Of Bending:2times	Should Pass Sealing And Visual Test.
<b>MARKING ERASE</b>	Submerge The Unit Into Ipa [isopropyl Alcohol] Solution For 10minutes And Brush The Marking 10 Times With A Tooth Brush.	Marking Should Not Be Erased.

**MHZ PLASTIC SMD CRYSTALS 8038 TYPE CCMD SERIES**

**SUGGESTED REFLOW PROFILE (For Reference Only)**

Total time: 200 Sec. Max. Solder melting point: 220°C



<b>Profile Feature</b>		Pb-Free Assembly
<b>Average Ramp-up Rate (Ts Max to Tp)</b>		3°C/second Max
<b>Preheat</b>	<b>Temperature Min (Ts Min.)</b>	125°C
	<b>Temperature Max (Ts Max.)</b>	200°C
	<b>Time (ts Min. to ts Max.)</b>	60 ~ 180 seconds
<b>Time maintained above</b>	<b>Temperature (T<sub>L</sub>)</b>	217°C
	<b>Time (t<sub>L</sub>)</b>	60 ~ 150 seconds
<b>Peak/Classification Temperature (T<sub>p</sub>)</b>		260 °C
<b>Time within 5°C of actual Peak Temperature (t<sub>p</sub>)</b>		20 ~ 40 seconds
<b>Ramp-down rate</b>		6 °C /Second Max.
<b>Time 25 °C to Peak Temperature</b>		8 minutes Max.
<b>Suggest reflow times</b>		3 Times Max.

**MHZ PLASTIC SMD CRYSTALS 8038 TYPE CCMD SERIES**

**TAPE/REEL (Unit: mm)**

All Devices are packed in accordance with EIA standard RS-481-2 and specifications, 3000pcs/Reel



Pieces per reel	$\phi m$	$\phi n$	L	Carrier tape size
3000/reel	$330 \pm 3$	80min	17.5	16

**DISCLAIMER**

NextGen Components, Inc. reserves the right to make changes to the product(s) and or information contained herein without notice. No liability is assumed as a result of their use or application. No rights under any patent accompany the sale of any such product(s) or information