



<b>DATA SHEET NO.</b>	R0501 - SMBJ130A00S0PK	
<b>DATE</b>	May 01, 2024	
<b>REVISION</b>	A2	Updated With Most Recent Data
<b>DESCRIPTION AND MAIN PARAMETRICS</b>	<p>SMD Transient Voltage Suppressor (TVs) Diodes, Case SMB/DO-214AA                  2 Pads, Unidirectional Type, Stand-off Voltage 130V                  Peak Pulse Power: 600 Watts Min. , Peak Pulse Current: 2.9A                  Operating Temp. Range -65°C ~+150°C,                  Package in Tape/Reel, 3000pcs/Reel                  RoHS/RoHS III compliant, RoHS Annex III lead Exemption                  (Exempt per RoHS EU 2015/863)</p>	
<b>CUSTOMER</b>		
<b>CUSTOMER PART NO.</b>		
<b>CROSS REF. PART NO.</b>		
<b>ORIGINAL MFG/PART NO</b>	MDD Diodes/SMBJ130A	
<b>PART CODE</b>	SMBJ130A00S0PK	

<b>VENDOR APPROVE</b>		
Issued/Checked/Approved		
		
DATE: May 01, 2024		

<b>CUSTOMER APPROVE</b>	
DATE:	

## SMD TRANSIENT VOLTAGE SUPPRESSORS DIODES SMBJ SERIES

### MAIN FEATURE

- The Plastic Package Carries Underwriters Laboratory Flammability Classification 94V-0
- Low Profile Package
- Built-in Strain Relief
- High Temperature Soldering Guaranteed: 260°C/ 10 Seconds At Terminals
- Glass Passivated Chip Junction
- Low Inductance
- Excellent Clamping Capability
- 600W Peak Pulse Power Capability At 10/1000 $\mu$ s Waveform
- Repetition Rate (Duty Cycle): 0.01%
- Fast Response Time
- Typical IR Less Than 1 $\mu$ A Above 10V
- Cross Competitors Parts and More.
- RoHS/RoHS III Compliant, RoHS Annex III Lead Exemption (Exempt per RoHS EU 2015/863)



### APPLICATION

- I/O Interface
- AC/DC Power Supply
- Low Frequency Signal Transmission Line (RS232, RS485, etc.)

### ELECTRICAL CHARACTERISTICS

- See Page 5 – Page 11

**SMD TRANSIENT VOLTAGE SUPPRESSORS DIODES SMBJ SERIES**

**HOW TO ORDER**

- Please follow up Part Code Guide and indicate pat code when you order or RFQ.

**PART CODE GUIDE**

**[RFQ](#)**  
[Request For Quotation](#)

SMBJ	130A	00S	OPK
1	2	3	4

1. SMBJ: Series Code, SMD Transient Voltage Suppressor (TVs) Diodes, Case SMB/DO-214AA
2. 130A: Unidirectional Type, Stand-off Voltage: 130V
3. 00S: Internal Control Code or Special Parameters Code, Letter A~Z, a~z or digits 0~9
4. OPK Marking Code For “PK” On The Case Surface, Different Marking For Different Specification.

**SMD TRANSIENT VOLTAGE SUPPRESSORS DIODES SMBJ SERIES**

**DIMENSION** (Unit: Inch/mm)

Image for reference



Marking:

See Page 6~ Page 11

Marking Code List

SMB/DO-214AA

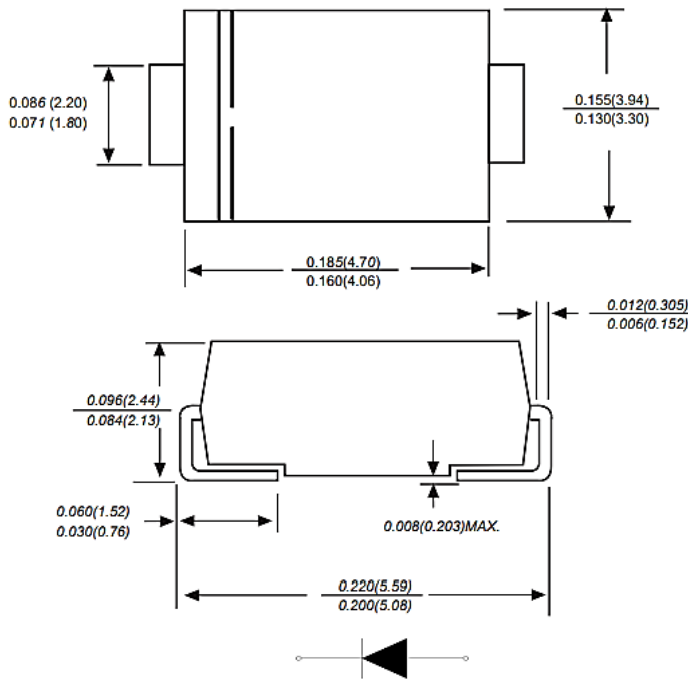

Recommend Pad Layout

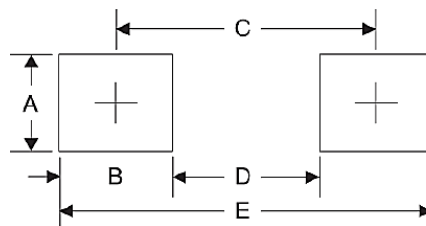

Symbol	Unit (inch)	Unit (mm)
A	0.110	2.80
B	0.094	2.40
C	0.181	4.60
D	0.086	2.20
E	0.276	7.00

## SMD TRANSIENT VOLTAGE SUPPRESSORS DIODES SMBJ SERIES

### MECHANICAL DATA

CASE	TERMINALS	POLARITY	MOUNTING POSITION	MARKING	WEIGHT PER PIECE
JEDEC SMB/DO-214AA Molded Plastic Body	Solderable per MIL-STD- 750, Method 2026	Polarity Symbol Marking On Body	Any	See Marking Code List	0.003 Ounce, 0.095 Grams

### MAX. RATING & CHARACTERISTICS - Ratings at 25°C Ambient Temperature Unless Otherwise Specified.

PARAMETER	SYMBOLS	VALUE	UNITS
Peak Pulse Power Dissipation At 10/1000µs Waveform (Note1, Note2, Fig.1)	P ppm	600 Min.	W
Peak Pulse Current On 10/1000 Us Waveform (Note 1, Fig 3)	I PPM	See Page 6~page 11	A
Steady State Power Dissipation At TA=50°C (Fig.5)-	P M(AV)	5.0	W
Peak Forward Surge Current, 8.3ms Single Half Sine-wave Superimposed On Rated Load, (JEDEC Method) (Note3, Fig.6)	I FSM	100	A
Operating Junction And Storage Temperature Range.	T J, T stg	-65 ~ +150	°C
Typical Thermal Resistance Junction To Lead	R θJL	20	°C/W
Typical Thermal Resistance Junction To Ambient	R θJA	100	°C/W

Note

1. Non-repetitive current pulse, per Fig 3 and derated above TA=25 °C per Fig 2
2. Mounted on 5.0\*5.0mm (0.03mm Thickness) copper pads to each terminal
3. 8.3ms single half sinewave or equivalent square wave, duty cycle=4 pulsed per minute Max.

## SMD TRANSIENT VOLTAGE SUPPRESSORS DIODES SMBJ SERIES

**UNIDIRECTIONAL TYPE- ELECTRICAL CHARACTERISTICS - Ta = 25°C**

Table 1

Part Code	Reverse Stand-off Voltage	Breakdown Voltage		Test Current	Reverse Leakage Max.	Max. Clamp Voltage	Peak Pulse Current	Marking Code
		V BR @ I T						
	V RMV	Min	Max	I T	I R @ V RWM	V C @ I PPM	I PPM	
	V	V	V	mA	µA	V	A	
SMBJ050A00S0KE	5	6.4	7	10	800	9.2	65.3	KE
SMBJ060A00S0KG	6	6.67	7.37	10	800	10.3	58.3	KG
SMBJ065A00S0KK	6.5	7.22	7.98	10	500	11.2	53.6	KK
SMBJ070A00S0KM	7	7.78	8.6	10	200	12	50	KM
SMBJ075A00S0KP	7.5	8.33	9.21	1	100	12.9	46.6	KP
SMBJ080A00S0KR	8	8.89	9.83	1	50	13.6	44.2	KR
SMBJ085A00S0KT	8.5	9.44	10.4	1	20	14.4	41.7	KT
SMBJ090A00S0KV	9	10	11.1	1	10	15.4	39	KV
SMBJ10A00S0KX	10	11.1	12.3	1	5	17	35.3	KX
SMBJ11A00S0KZ	11	12.2	13.5	1	1	18.2	33	KZ
SMBJ12A00S0LE	12	13.3	14.7	1	1	19.9	30.2	LE
SMBJ13A00S0LG	13	14.4	15.9	1	1	21.5	28	LG
SMBJ14A00S0LK	14	15.6	17.2	1	1	23.2	25.9	LK
SMBJ15A00S0LM	15	16.7	18.5	1	1	24.4	24.6	LM
SMBJ16A00S0LP	16	17.8	19.7	1	1	26	23.1	LP
SMBJ17A00S0LR	17	18.9	20.9	1	1	27.6	21.8	LR
SMBJ18A00S0LT	18	20	22.1	1	1	29.2	20.6	LT
SMBJ20A00S0LV	20	22.2	24.5	1	1	32.4	18.6	LV
SMBJ22A00S0LX	22	24.4	26.9	1	1	35.5	16.9	LX
SMBJ24A00S0LZ	24	26.7	29.5	1	1	38.9	15.5	LZ

**SMD TRANSIENT VOLTAGE SUPPRESSORS DIODES SMBJ SERIES**
**UNIDIRECTIONAL TYPE- ELECTRICAL CHARACTERISTICS - Ta = 25°C**

Table 2

Part Code	Reverse Stand-off Voltage	Breakdown Voltage		Test Current	Reverse Leakage Max.	Max. Clamp Voltage	Peak Pulse Current	Marking Code
		V BR @ I T						
	V RMV	Min	Max	I T	I R @ V RWM	V C @ I PPM	I PPM	
	V	V	V	mA	µA	V	A	
SMBJ26A000S0ME	26	28.9	31.9	1	1	42.1	14.3	ME
SMBJ28A000S0MG	28	31.1	34.4	1	1	45.4	13.3	MG
SMBJ30A000S0MK	30	33.3	36.8	1	1	48.4	12.4	MK
SMBJ33A000S0MM	33	36.7	40.6	1	1	53.3	11.3	MM
SMBJ36A000S0MP	36	40	44.2	1	1	58.1	10.4	MP
SMBJ40A000S0MR	40	44.4	49.1	1	1	64.5	9.3	MR
SMBJ43A000S0MT	43	47.8	52.8	1	1	69.4	8.7	MT
SMBJ45A000S0MV	45	50	55.3	1	1	72.7	8.3	MV
SMBJ48A000S0MX	48	53.3	58.9	1	1	77.4	7.8	MX
SMBJ51A000S0MZ	51	56.7	62.7	1	1	82.4	7.3	MZ
SMBJ54A000S0NE	54	60	66.3	1	1	87.1	6.9	NE
SMBJ58A000S0NG	58	64.4	71.2	1	1	93.6	6.5	NG
SMBJ60A000S0NK	60	66.7	73.7	1	1	96.8	6.2	NK
SMBJ64A000S0NM	64	71.1	78.6	1	1	103	5.9	NM
SMBJ70A000S0NP	70	77.8	86	1	1	113	5.3	NP
SMBJ75A000S0NR	75	83.3	92.1	1	1	121	5	NR
SMBJ78A000S0NT	78	86.7	95.8	1	1	126	4.8	NT
SMBJ85A000S0NV	85	94.4	104	1	1	137	4.4	NV
SMBJ90A000S0NX	90	100	111	1	1	146	4.1	NX
SMBJ100A00S0NZ	100	111	123	1	1	162	3.7	NZ

## SMD TRANSIENT VOLTAGE SUPPRESSORS DIODES SMBJ SERIES

**UNIDIRECTIONAL TYPE- ELECTRICAL CHARACTERISTICS - Ta = 25°C**

Table 3

Part Code	Reverse Stand-off Voltage	Breakdown Voltage		Test Current	Reverse Leakage Max.	Max. Clamp Voltage	Peak Pulse Current	Marking Code
		V BR @ I T						
	V RMV	Min	Max	I T	I R @ V RWM	V C @ I PPM	I PPM	
	V	V	V	mA	µA	V	A	
SMBJ110A00S0PE	110	122	135	1	1	177	3.4	PE
SMBJ120A00S0PG	120	133	147	1	1	193	3.1	PG
<b>SMBJ130A00S0PK</b>	<b>130</b>	<b>144</b>	<b>159</b>	<b>1</b>	<b>1</b>	<b>209</b>	<b>2.9</b>	<b>PK</b>
SMBJ150A00S0PM	150	167	185	1	1	243	2.5	PM
SMBJ160A00S0PP	160	178	197	1	1	259	2.3	PP
SMBJ170A00S0PR	170	189	209	1	1	275	2.2	PR
SMBJ180A00S0PT	180	201	222	1	1	292	2.1	PT
SMBJ190A00S0PA	190	211	232	1	1	308	2.0	PA
SMBJ200A00S0PV	200	224	247	1	1	324	1.9	PV
SMBJ210A00S0PB	210	237	263	1	1	340	1.8	PB
SMBJ220A00S0PX	220	246	272	1	1	356	1.7	PX
SMBJ250A00S0PZ	250	279	309	1	1	405	1.5	PZ
SMBJ300A00S0QE	300	335	371	1	1	486	1.3	QE
SMBJ350A00S0QG	350	391	432	1	1	567	1.1	QG
SMBJ400A00S0QK	400	447	494	1	1	648	0.9	QK
SMBJ440A00S0QM	440	492	543	1	1	713	0.9	QM



## SMD TRANSIENT VOLTAGE SUPPRESSORS DIODES SMBJ SERIES

**BIDIRECTIONAL TYPE- ELECTRICAL CHARACTERISTICS - Ta = 25°C**

Table 4

Part Code	Reverse Stand-off Voltage	Breakdown Voltage		Test Current	Reverse Leakage Max.	Max. Clamp Voltage	Peak Pulse Current	Marking Code
		V BR @ I T						
	V RMV	Min	Max	I T	I R @ V RWM	V C @ I PPM	I PPM	
V	V	V	mA	µA	V	A		
SMBJ050CA0S0AE	5	6.4	7	10	800	9.2	65.3	AE
SMBJ060CA0S0AG	6	6.67	7.37	10	800	10.3	58.3	AG
SMBJ065CA0S0AK	6.5	7.22	7.98	10	500	11.2	53.6	AK
SMBJ070CA0S0AM	7	7.78	8.6	10	200	12	50	AM
SMBJ075CA0S0AP	7.5	8.33	9.2	1	100	12.9	46.6	AP
SMBJ080CA0S0AR	8	8.89	9.83	1	50	13.6	44.2	AR
SMBJ085CA0S0AT	8.5	9.44	10.4	1	20	14.4	41.7	AT
SMBJ090CA0S0AV	9	10	11.1	1	10	15.4	39	AV
SMBJ10CA00S0AX	10	11.1	12.3	1	5	17	35.3	AX
SMBJ11CA00S0AZ	11	12.2	13.5	1	1	18.2	33	AZ
SMBJ12CA00S0BE	12	13.3	14.7	1	1	19.9	30.2	BE
SMBJ13CA00S0BG	13	14.4	15.9	1	1	21.5	28	BG
SMBJ14CA00S0BK	14	15.6	17.2	1	1	23.2	25.9	BK
SMBJ15CA00S0BM	15	16.7	18.5	1	1	24.4	24.6	BM
SMBJ16CA00S0BP	16	17.8	19.7	1	1	26	23.1	BP
SMBJ17CA00S0BR	17	18.9	20.9	1	1	27.6	21.8	BR
SMBJ18CA00S0BT	18	20	22.1	1	1	29.2	20.6	BT
SMBJ20CA00S0BV	20	22.2	24.5	1	1	32.4	18.6	BV
SMBJ22CA00S0BX	22	24.4	26.9	1	1	35.5	16.9	BX
SMBJ24CA00S0BZ	24	26.7	29.5	1	1	38.9	15.5	BZ

**SMD TRANSIENT VOLTAGE SUPPRESSORS DIODES SMBJ SERIES**
**BIDIRECTIONAL TYPE- ELECTRICAL CHARACTERISTICS - Ta = 25°C**

Table 5

Part Code	Reverse Stand-off Voltage	Breakdown Voltage		Test Current	Reverse Leakage Max.	Max. Clamp Voltage	Peak Pulse Current	Marking Code
		V BR @ I T						
	V RMV	Min	Max	I T	I R @ V RWM	V C @ I PPM	I PPM	
	V	V	V	mA	µA	V	A	
SMBJ26CA00S0CE	26	28.9	31.9	1	1	42.1	14.3	CE
SMBJ28CA00S0CG	28	31.1	34.4	1	1	45.4	13.3	CG
SMBJ30CA00S0CK	30	33.3	36.8	1	1	48.4	12.4	CK
SMBJ33CA00S0CM	33	36.7	40.6	1	1	53.3	11.3	CM
SMBJ36CA00S0CP	36	40	44.2	1	1	58.1	10.4	CP
SMBJ40CA00S0CR	40	44.4	49.1	1	1	64.5	9.3	CR
SMBJ43CA00S0CT	43	47.8	52.8	1	1	69.4	8.7	CT
SMBJ45CA00S0CV	45	50	55.3	1	1	72.7	8.3	CV
SMBJ48CA00S0CX	48	53.3	58.9	1	1	77.4	7.8	CX
SMBJ51CA00S0CZ	51	56.7	62.7	1	1	82.4	7.3	CZ
SMBJ54CA00S0DE	54	60	66.3	1	1	87.1	6.9	DE
SMBJ58CA00S0DG	58	64.4	71.2	1	1	93.6	6.5	DG
SMBJ60CA00S0DK	60	66.7	73.7	1	1	96.8	6.2	DK
SMBJ64CA00S0DM	64	71.1	78.6	1	1	103	5.9	DM
SMBJ70CA00S0DP	70	77.8	86	1	1	113	5.3	DP
SMBJ75CA00S0DR	75	83.3	92.1	1	1	121	5	DR
SMBJ78CA00S0DT	78	86.7	95.8	1	1	126	4.8	DT
SMBJ85CA00S0DV	85	94.4	104	1	1	137	4.4	DV
SMBJ90CA00S0DX	90	100	111	1	1	146	4.1	DX
SMBJ100CA00S0DZ	100	111	123	1	1	162	3.7	DZ

## SMD TRANSIENT VOLTAGE SUPPRESSORS DIODES SMBJ SERIES

**BIDIRECTIONAL TYPE- ELECTRICAL CHARACTERISTICS - Ta = 25°C**

Table 6

Part Code	Reverse Stand-off Voltage	Breakdown Voltage		Test Current	Reverse Leakage Max.	Max. Clamp Voltage	Peak Pulse Current	Marking Code
		V BR @ I T						
	V RMV	Min	Max	I T	I R @ V RWM	V C @ I PPM	I PPM	
V	V	V	mA	µA	V	A		
SMBJ110CA0S0EE	110	122	135	1	1	177	3.4	EE
SMBJ120CA0S0EG	120	133	147	1	1	193	3.1	EG
SMBJ130CA0S0EK	130	144	159	1	1	209	2.9	EK
SMBJ150CA0S0EM	150	167	185	1	1	243	2.5	EM
SMBJ160CA0S0EP	160	178	197	1	1	259	2.3	EP
SMBJ170CA0S0ER	170	189	209	1	1	275	2.2	ER
SMBJ180CA0S0ET	180	201	222	1	1	292	2.1	ET
SMBJ190CA0S0EC	190	211	232	1	1	308	2.0	EC
SMBJ200CA0S0EV	200	224	247	1	1	324	1.9	EV
SMBJ210CA0S0ED	210	237	263	1	1	340	1.8	ED
SMBJ220CA0S0EX	220	246	272	1	1	356	1.7	EX
SMBJ250CA0S0EZ	250	279	309	1	1	405	1.5	EZ
SMBJ300CA0S0FE	300	335	371	1	1	486	1.3	FE
SMBJ350CA0S0FG	350	391	432	1	1	567	1.1	FG
SMBJ400CA0S0FK	400	447	494	1	1	648	0.9	FK
SMBJ440CA0S0FM	440	492	543	1	1	713	0.9	FM

**SMD TRANSIENT VOLTAGE SUPPRESSORS DIODES SMBJ SERIES**

**RATINGS AND CHARACTERISTIC CURVES** (For Reference Only)

Figure 1. Peak Pulse Power Rating Curve

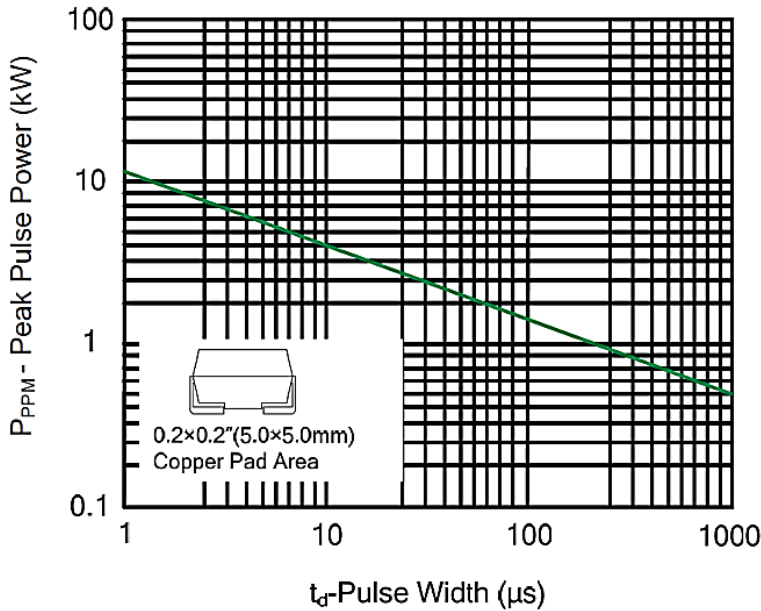
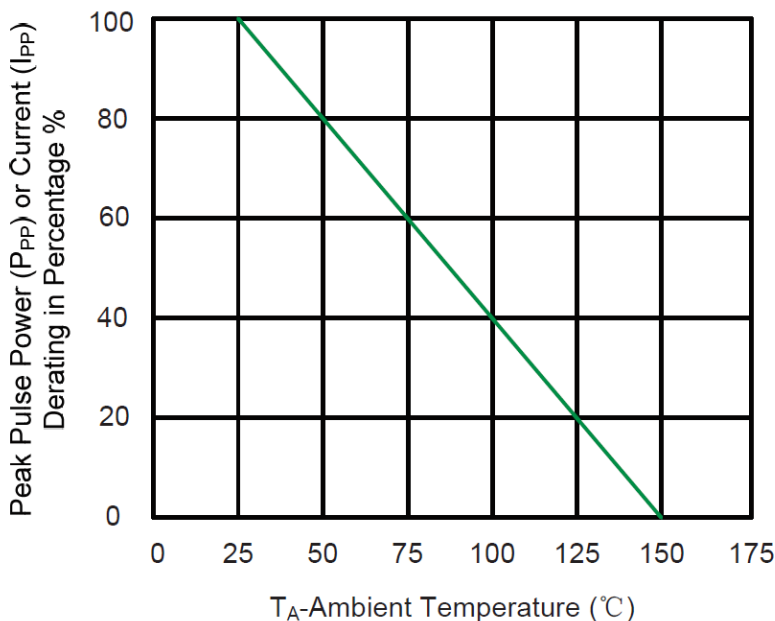

Figure 2. Pulse Derating Curve



**SMD TRANSIENT VOLTAGE SUPPRESSORS DIODES SMBJ SERIES**

**RATINGS AND CHARACTERISTIC CURVES (For Reference Only)**

Figure 3. Pulse Waveform

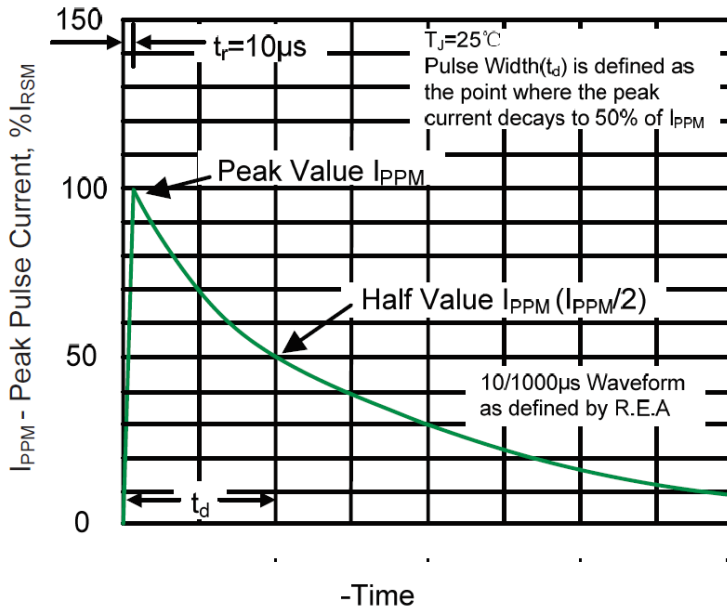
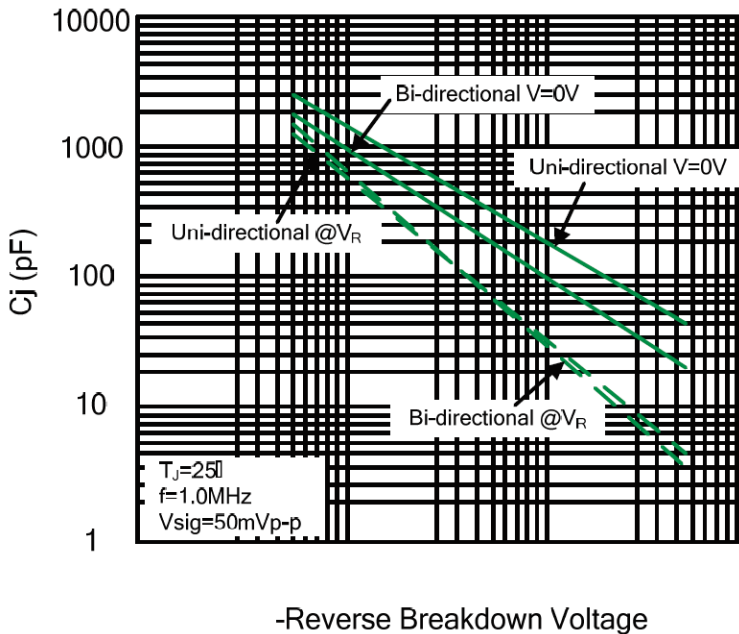

Figure 4. Typical Junction Capacitance



**SMD TRANSIENT VOLTAGE SUPPRESSORS DIODES SMBJ SERIES**

**RATINGS AND CHARACTERISTIC CURVES** (For Reference Only)

Figure 5. Steady State Power Dissipation Derating curve

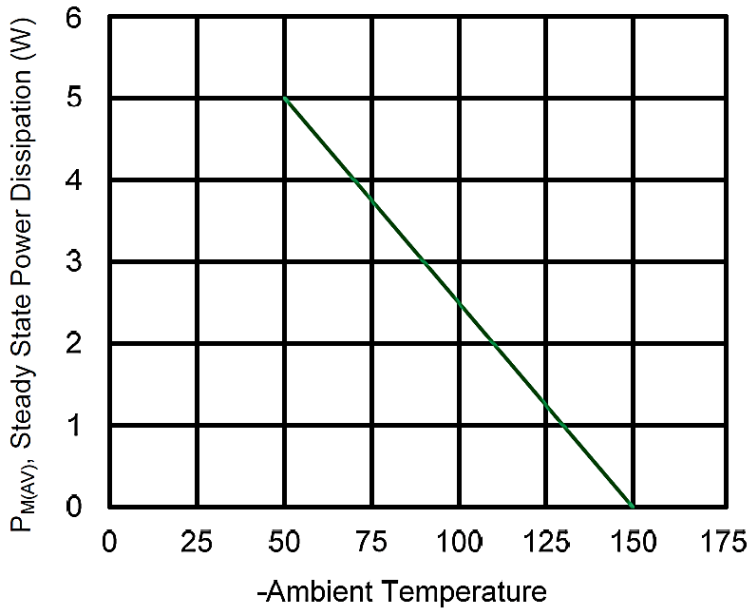
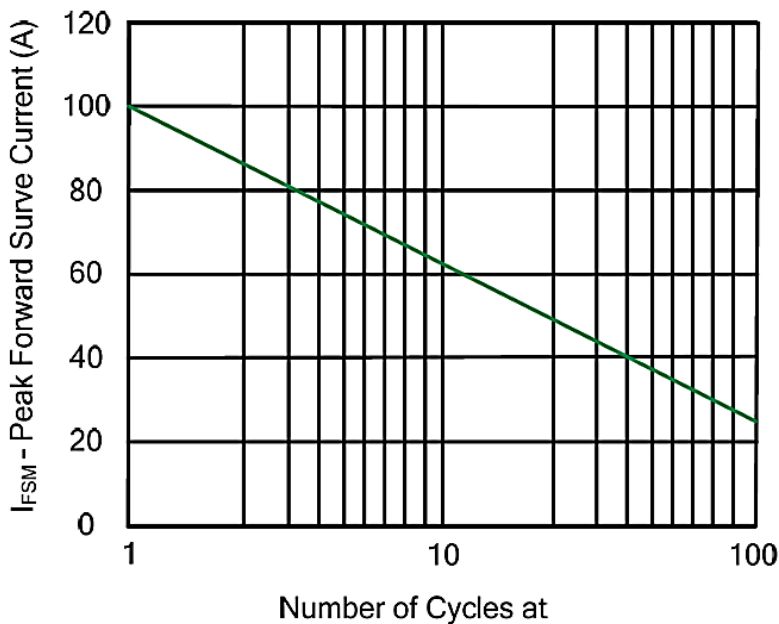

Figure 6. Maximum Non-Repetitive Forward Surge Current Uni-Directional Only



# SMD TRANSIENT VOLTAGE SUPPRESSORS DIODES SMBJ SERIES

**RELIABILITY**

Number	Experiment Items	Experiment Method And Conditions	Reference Documents
1	Solder Resistance Test	Test 260°C± 5°C for 10 ± 2 sec. Immerse body into solder 1/16" ± 1/32"	MIL-STD-750D METHOD-2031.2
2	Solderability Test	230°C ±5°C for 5 sec.	MIL-STD-750D METHOD-2026.1 0
3	Pull Test	1 kg in axial lead direction for 10 sec.	MIL-STD-750D METHOD-2036.4
4	Bend Test	0.5Kg Weight Applied To Each Lead, Bending Arcs 90 °C ± 5 °C For 3 Times	MIL-STD-750D METHOD-2036.4
5	High Temperature Reverse Bias Test	TA=100°C for 1000 Hours at VR=80% Rated VR	MIL-STD-750D METHOD-1038.4
6	Forward Operation Life Test	TA=25°C Rated Average Rectified Current	MIL-STD-750D METHOD-1027.3
7	Intermittent Operation Life Test	On state: 5 min with rated IRMS Power Off state: 5 min with Cool Forced Air. On and off for 1000 cycles.	MIL-STD-750D METHOD-1036.3
8	Pressure Cooker Test	15 PSIG, TA=121°C, 4 hours	MIL-S-19500 APPENOIXC
9	Temperature Cycling Test	-55°C~+125°C; 30 Minutes For Dwelled Time 5 minutes for transferred time. Total: 10 cycles.	MIL-STD-750D METHOD-1051.7
10	Thermal Shock Test	0°C for 5 minutes., 100°C for 5minutes, Total: 10 cycles	MIL-STD-750D METHOD-1056.7
11	Forward Surge Test	8.3ms Single Sale Sine-wave One Surge.	MIL-STD-750D METHOD-4066.4
12	Humidity Test	TA=65°C, RH=98% for 1000 hours.	MIL-STD-750D METHOD-1021.3
13	High Temperature Storage life Test	150°C for 1000 Hours	MIL-STD-750D METHOD-1031.5

**SMD TRANSIENT VOLTAGE SUPPRESSORS DIODES SMBJ SERIES**

**SUGGESTED REFLOW PROFILE** (For Reference Only)



Profile Feature		Pb-Free Assembly
Average Ramp-up Rate (Ts Max to Tp)		3°C/second Max
Preheat	Temperature Min (Ts Min.)	150°C
	Temperature Max (Ts Max.)	200°C
	Time (ts Min. to ts Max.)	60 ~ 180 seconds
Time maintained above	Temperature (Tl)	217°C
	Time (tl)	60 ~ 150 seconds
Peak/Classification Temperature (Tp)		260 °C
Time within 5°C of actual Peak Temperature (tp)		20 ~ 40 seconds
Ramp-down rate		6 °C /Second Max.
Time 25 °C to Peak Temperature		8 minutes Max.
Suggest reflow times		3 Times Max.



**SMD TRANSIENT VOLTAGE SUPPRESSORS DIODES SMBJ SERIES**
**TAPE/REEL** (Unit: mm) (For Reference Only)

All Devices are packed in accordance with EIA standard RS-481-A and specifications.

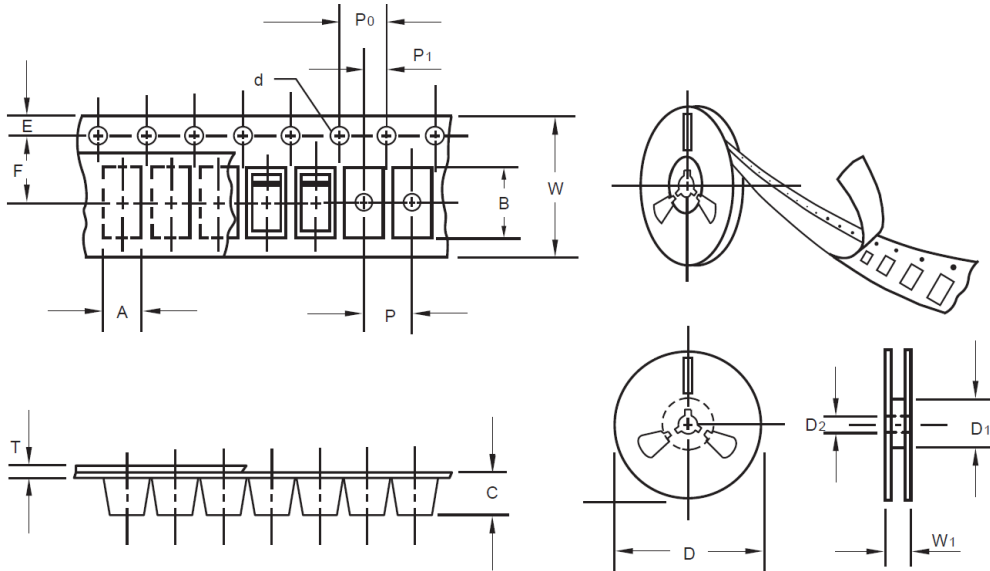

Item	Symbol	Tolerance	SMB/DO-214AA
Carrier width	A	0.1	3.81
Carrier Length	B	0.1	5.41
Carrier Depth	C	0.1	2.42
Sprocket hole	d	0.05	1.50
13"Reel outside diameter	D	2.0	330.00
13"Reel inner diameter	D1	Min.	50.00
Feed hole diameter	D2	0.5	13.00
Sprocket hole position	E	0.1	1.75
Punch hole position	F	0.1	5.55
Punch hole pitch	P	0.1	8.00
Sprocket hole pitch	P0	0.1	4.00
Embossment center	P1	0.1	2.00
Overall tape thickness	T	0.1	0.30
Tape width	W	0.3	12.00
Reel width	W1	1.0	12.30
Qty./Reel (pcs)	3000		

## SMD TRANSIENT VOLTAGE SUPPRESSORS DIODES SMBJ SERIES

### IMPORTANT NOTES AND DISCLAIMER

1. RoHS Compliance: The levels of RoHS restricted materials in this product are below the maximum concentration values (also referred to as the threshold limits) permitted for such substances, or are used in an exempted application, in accordance with EU RoHS Directive (EU) 2015/863 EC (RoHS3). RoHS Test Report for this product can be obtained at Download Center.
2. REACH Compliance: REACH substances of high concern (SVHCs) information is available for this product. Since the European Chemical Agency (ECHA) has published notice of their intent to frequently revise the SVHC listing for the foreseeable future, REACH Test Report for this product can be obtained at Download Center.
3. All Product parametric performance is indicated in the Electrical Characteristics for the listed herein test conditions, unless otherwise noted. Product performance may not be indicated by the Electrical Characteristics if operated under different conditions.
4. NextGen Component, Inc (*NextGen*) reserves the right to make changes to this document and its products and specifications at any time without notice. Customers should obtain and confirm the latest product information and specifications before final design, purchase or use.
5. *NextGen* makes no warranty, representation or guarantee regarding the suitability of its products for any particular purpose, not does NextGen assume any liability for application assistance or customer product design.
6. *NextGen* does not warrant or accept any liability with products which are purchased or used for any unintended or unauthorized application. No license is granted by implication or otherwise under any intellectual property rights of *NextGen*.
7. *NextGen* products are not authorized for use as critical components in life support devices or systems without express written approval by *NextGen*.
8. *NextGen* requires that customers first obtain an RMA (Returned Merchandise Authorization) number prior to returning any products. Returns must be made within 30 days of the date of invoice, be in the original packaging, unused and like-new condition. At the time of quoting or purchasing, a product may say that it is Non-Cancelable/ Non-Returnable (NCNR). These products are not returnable and not refundable.