



CertusPro-NX Evaluation Board

User Guide

FPGA-EB-02046-1.1

April 2022

Disclaimers

Lattice makes no warranty, representation, or guarantee regarding the accuracy of information contained in this document or the suitability of its products for any particular purpose. All information herein is provided AS IS, with all faults and associated risk the responsibility entirely of the Buyer. Buyer shall not rely on any data and performance specifications or parameters provided herein. Products sold by Lattice have been subject to limited testing and it is the Buyer's responsibility to independently determine the suitability of any products and to test and verify the same. No Lattice products should be used in conjunction with mission- or safety-critical or any other application in which the failure of Lattice's product could create a situation where personal injury, death, severe property or environmental damage may occur. The information provided in this document is proprietary to Lattice Semiconductor, and Lattice reserves the right to make any changes to the information in this document or to any products at any time without notice.

Contents

Acronyms in This Document.....	5
1. Introduction.....	6
1.1. CertusPro-NX Evaluation Board	6
1.2. Features	6
1.3. CertusPro-NX Device	9
1.4. Applying Power to the Board	9
2. Jumper Definition	10
3. Power Scheme	12
4. Programming and I ² C.....	15
4.1. JTAG Download Interface.....	15
4.2. Alternate JTAG Download Interface.....	15
4.3. JTAG to MSPI Pass-through Interface	15
4.4. SPI Flash Device Selection in Programmer	16
4.5. Global Setting in Lattice Radiant software.....	17
4.6. Other JTAG Configuration Pins.....	20
5. CertusPro-NX Clock Sources	21
6. Control Buses – I ² C, UART, and SPI	22
6.1. I ² C Topology	22
6.2. UART Topology.....	22
6.3. SPI Topology.....	22
7. LEDs and Switches	23
7.1. DIP Switch	23
7.2. General Purpose Push Buttons	23
7.3. General Purpose LEDs	24
8. Headers/Connectors and CertusPro-NX Device Ball Mapping	25
8.1. SMA Header	25
8.2. FMC Connector	25
8.3. Parallel FMC Configuration Header.....	29
8.4. Raspberry PI Board GPIO Header	29
8.5. External Flash Configuration Header	31
8.6. ADC Test Header	32
8.7. PMOD Header	33
8.8. Through Hole Extended Area Header	34
9. Software Requirements.....	36
10. Storage and Handling	36
11. Ordering Information.....	36
Appendix A. CertusPro-NX Evaluation Board Schematics	37
Appendix B. CertusPro-NX Evaluation Board Bill of Materials	54
References	63
Technical Support Assistance	64
Revision History	65

Figures

Figure 1.1. Top View of CertusPro-NX Evaluation Board	7
Figure 1.2. Bottom View of CertusPro-NX Evaluation Board	8
Figure 1.3. 12 V DC Power Supply	9
Figure 2.1. Top View of CertusPro-NX Evaluation Board – Jumper Locations	10
Figure 3.1. Board Power Scheme	13
Figure 4.1. Configuration and I ² C Architecture	15
Figure 4.2. SPI Flash Operation Dialog	16
Figure 4.3. Global Setting (1)	18
Figure 4.4. Global Setting (2)	19
Figure A.1. Title Page	37
Figure A.2. Block Diagram	38
Figure A.3. USB Interface	39
Figure A.4. Bank-0 Configuration	40
Figure A.5. Bank-1 LEDs & JTAG	41
Figure A.6. Bank-2 PMODs	42
Figure A.7. Bank-3,4,5 FMC	43
Figure A.8. HPC	44
Figure A.9. Bank-6 Extended Bank	45
Figure A.10. Bank-7 Raspberry PI	46
Figure A.11. SerDes	47
Figure A.12. ADC	48
Figure A.13. Bank Power	49
Figure A.14. Power Decoupling	50
Figure A.15. Power Regulators	51
Figure A.16. Ground	52
Figure A.17. Power Block Diagram	53

Tables

Table 1.1. Board Power Supply	9
Table 2.1. Jumper Setting	11
Table 3.1. VCCIO Supply Options	14
Table 3.2. Status LED Definition	14
Table 4.1. JTAG Connections	15
Table 4.2. Other JTAG Signals	20
Table 5.1. Clock Sources	21
Table 6.1. I ² C Bus Connections	22
Table 6.2. UART Bus Connections	22
Table 6.3. SPI Bus Connections	22
Table 7.1. DIP Switch Signals	23
Table 7.2. Push Button Switch Signals	23
Table 7.3. General Purpose LED Signals	24
Table 8.1. SMA Header Connections	25
Table 8.2. HPC Pin Connections	25
Table 8.3. Parallel FMC Configuration Header Pin Connections	29
Table 8.4. Raspberry PI header Pin Connections	29
Table 8.5. SPI Flash Configuration Header Pin Connections	31
Table 8.6. ADC Header Pin Connections	32
Table 8.7. PMOD Header Pin Connections	33
Table 8.8. Through Hole Extended Area Header Pin Connections	34
Table 11.1. Ordering Information	36

Acronyms in This Document

A list of acronyms used in this document.

Acronym	Definition
AC/DC	Alternating Current and Direct Current
ADC	Analog-to-digital Converter
DIP	Dual Inline Package
ESD	Electro Static Discharge
FMC	FPGA Mezzanine Card
FPGA	Field Programmable Gate Array
FTDI	Future Technology Devices International
GPIO	General Purpose Input/Output
HPC	High Pin Connector
I2C	Inter-Integrated Circuit
I/O	Input/Output
JTAG	Joint Test Action Group
LED	Light Emitting Diode
LVDS	Low-Voltage Differential Signaling
OSC	Oscillator
PC	Personal Computer
PMOD	Peripheral Module
POT	Potentiometer
SerDes	Serializer/Deserializer
SMA	Subminiature Version A
SPI	Serial Peripheral Interface
UART	Universal Asynchronous Receiver Transmitter
USB	Universal Serial Bus

1. Introduction

The Lattice Semiconductor CertusPro™-NX Evaluation Board allows you to investigate and experiment with the features of the CertusPro-NX Field Programmable Gate Array (FPGA). The features of the CertusPro-NX Evaluation Board can assist you with the rapid prototyping and testing of your specific design. The CertusPro-NX Evaluation board is part of the CertusPro-NX Evaluation Board Kit. This guide is intended to be referenced to demonstrate the CertusPro-NX FPGA and introduce board resource.

The CertusPro-NX Evaluation Board Kit includes the following:

- CertusPro-NX Evaluation Board pre-loaded with blinking lights demo design
- USB-A to USB-B (Mini) cable for programming FPGA through a PC
- 12 V AC/DC power adapter and international plug adapters
- Lattice Radiant® software download information

The contents of this user guide include top-level functional descriptions of the various portions of the evaluation board, descriptions of the on-board headers, status indicators, push buttons and switches and a complete set of schematics.

1.1. CertusPro-NX Evaluation Board

The CertusPro-NX Evaluation Board features the CertusPro-NX FPGA in the LFG672 package which is built on Lattice Nexus™ FPGA platform using low power 28 nm FD-SOI technology. The board has the ability to expand the usability of the CertusPro-NX FPGA with FMC HPC connector, PMOD, Raspberry PI, along with access to 8× SerDes channels. Easy-to-use board resources of the jumper, LED indicator, push button and switch are available for user-defined applications.

[Figure 1.1](#) shows the top view of CertusPro-NX Evaluation Board. [Figure 1.2](#) shows the bottom view of CertusPro-NX Evaluation Board.

1.2. Features

The CertusPro-NX Evaluation Board includes the following features:

- CertusPro-NX FPGA (LFCPNX-100-9LFG672C)
- General purpose Input/Output (GPIO) breakout with FMC connector, PMOD, and Raspberry PI
- 4× SerDes channels with SMA and 4× SerDes channels with HPC connector
- Total of 167 wide-range I/O and 132 high-speed differential I/O pairs extended onboard
- 2.54-mm standard GPIO extended area
- USB-B connection for device programming and Inter-Integrated Circuit Bus (I²C) utility
- On-board Boot Flash – 128 Mb Serial Peripheral Interface (SPI) Flash, with Quad read feature
- Eight input DIP switches, four push buttons, 24 status LEDs for customer purposes
- Lattice Radiant® software programming support
- Multiple reference clock sources
- Potentiometer for ADC test

Caution: The CertusPro-NX Evaluation Board contains ESD-sensitive components. ESD safe practices should be followed while handling and using the evaluation board.

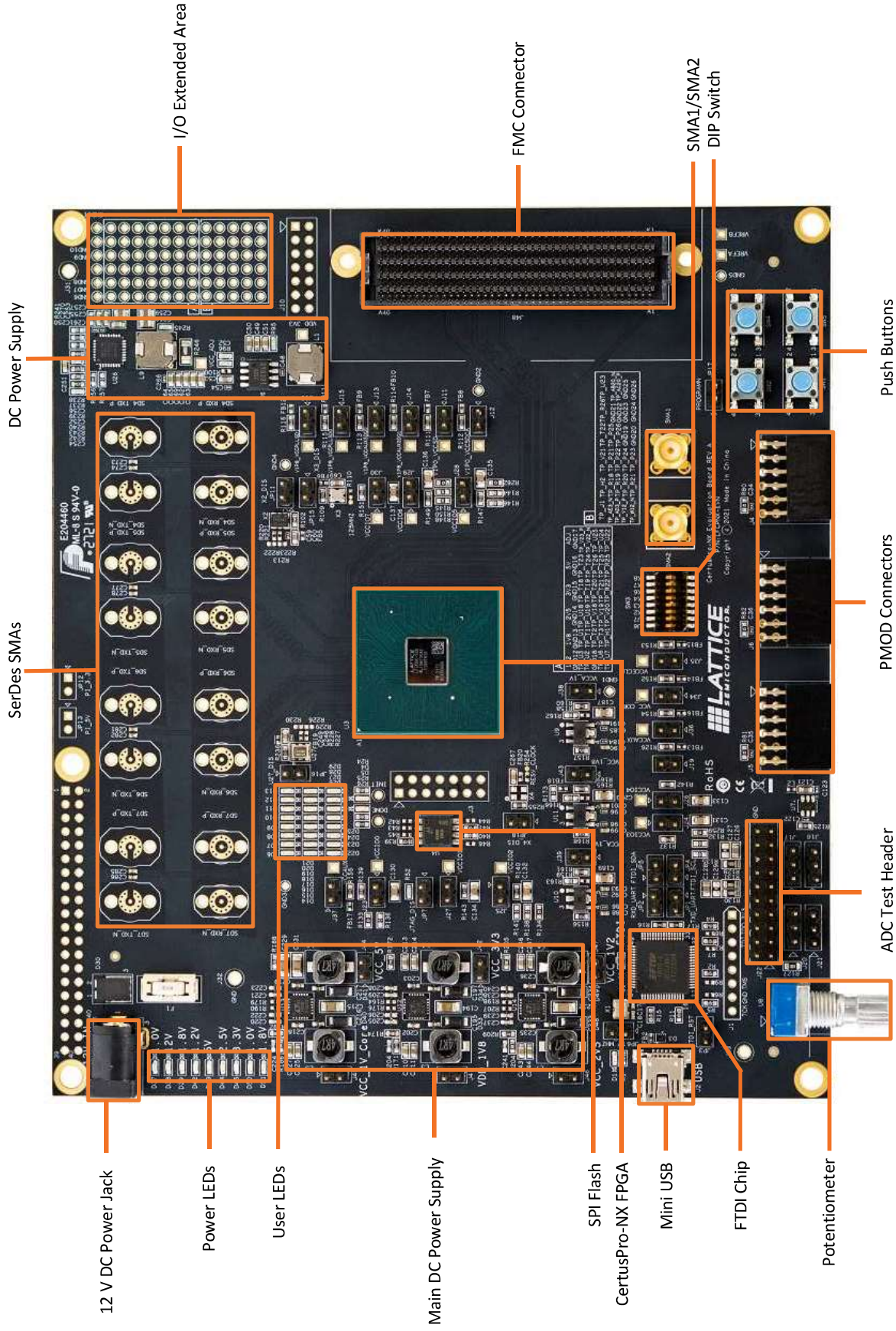

Figure 1.1. Top View of CertusPro-NX Evaluation Board

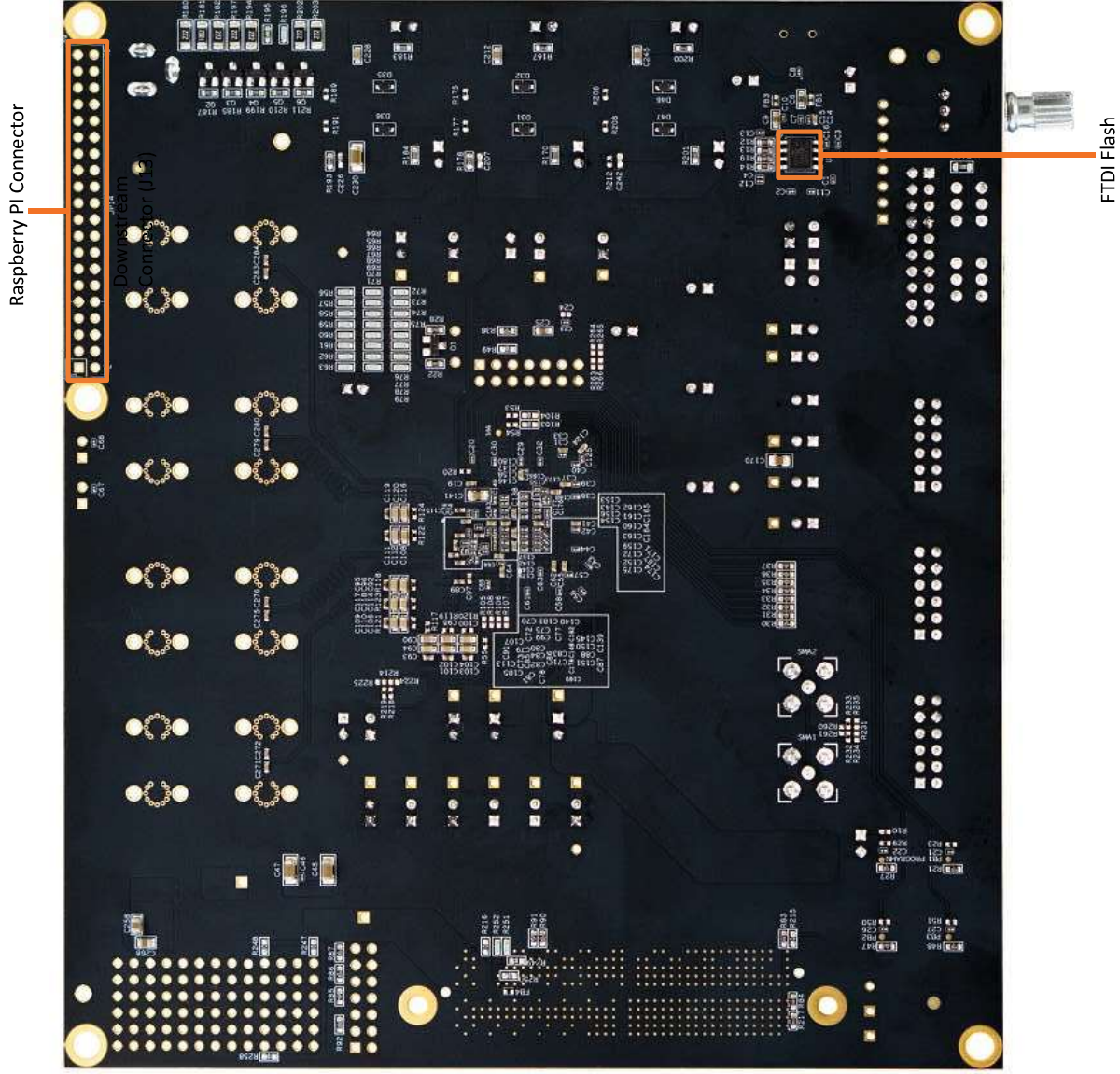

Figure 1.2. Bottom View of CertusPro-NX Evaluation Board

© 2021-2022 Lattice Semiconductor Corp. All Lattice trademarks, registered trademarks, patents, and disclaimers are as listed at www.latticesemi.com/legal. All other brand or product names are trademarks or registered trademarks of their respective holders. The specifications and information herein are subject to change without notice.

1.3. CertusPro-NX Device

The CertusPro-NX Evaluation Board features the CertusPro-NX device in an LFG672 package, also referred to as LFCPNX-100-9LFG672C. The low-power general purpose FPGA can be used in a wide range of applications across multiple markets, and is optimized for bridging and processing needs in edge applications. For more information on the capabilities of CertusPro-NX device, see [CertusPro-NX Family Data Sheet \(FPGA-DS-02086\)](#).

1.4. Applying Power to the Board

The CertusPro-NX Evaluation Board comes ready to power up. The board can power up using a 12 V DC power source input. The power supply can be connected with the right-angle DC power input jack J40, which is fused with a surface mounted fuse F1, as shown in [Figure 1.3](#) and [Table 1.1](#). The fuse can prevent the crashed current from flowing into the internal circuits and cause serious damage. Power LEDs light after applying 12 V DC power to the CertusPro-NX Evaluation Board to indicate that the board is functioning.

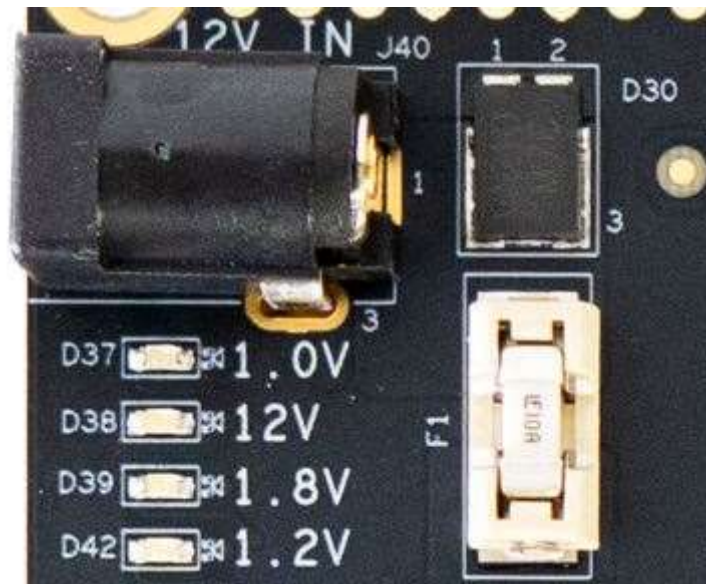

Figure 1.3. 12 V DC Power Supply

Table 1.1. Board Power Supply

Part Designator	Description
J40	12 V DC Input Supply Jack
F1	12 V DC Input Supply Fuse

2. Jumper Definition

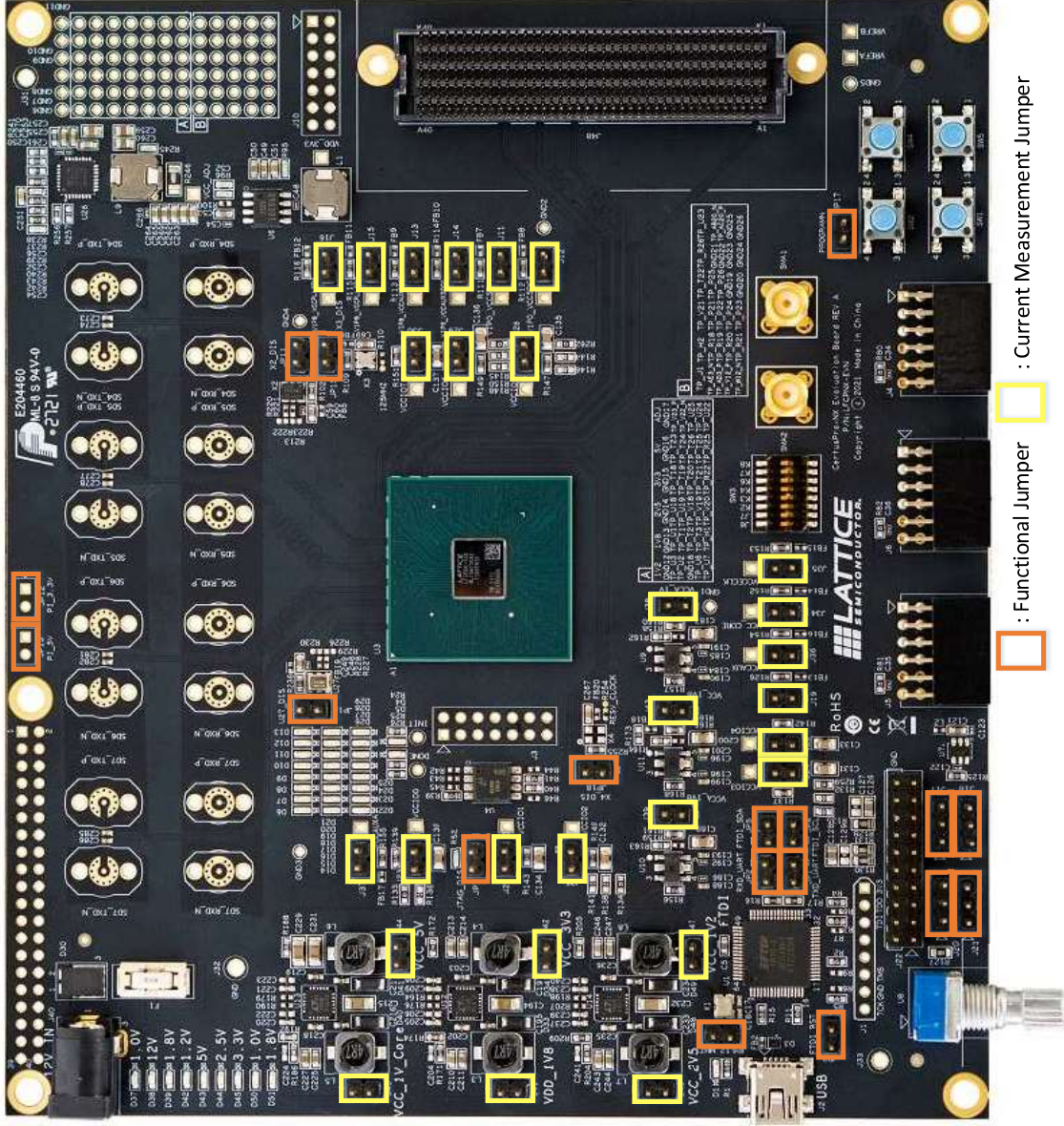

Figure 2.1. Top View of CertusPro-NX Evaluation Board – Jumper Locations

Table 2.1. Jumper Setting

Part Designator	Description	Setting
JP1, JP2	UART Debug Jumper	Default Short (UART bus connected)/Open (UART bus unconnected)
JP3	FTDI Reset Jumper	Default Open (Active FTDI)/Short (Reset FTDI)
JP4, JP5	I ² C Configuration Jumper	Default Open (I ² C bus unconnected)/Short (I ² C bus connected)
JP6	FTDI Oscillator Jumper	Default Short (12 MHz OSC connected)/Open (12 MHz OSC unconnected)
JP7	JTAG_EN Function Jumper	Default Open (Used as JTAG interface)/Short (Used as GPIO)
JP11, JP15, JP16, JP18	Oscillator Standby Jumper	Default Open (Clock output enable)/Short (Clock output disable)
JP12	Raspberry PI Connector Power	Default Open (Raspberry PI self-power)/Short (3.3 V applies Raspberry PI connector)
JP13	Raspberry PI Connector Power	Default Open (Raspberry PI self-power)/Short (5.0 V applies Raspberry PI connector)
JP17	PROGRAMN Pull-down Jumper	Default Open (MSPI booting mode)/Short (Slave configuration mode)
J17	ADC_REFP0 Selection Jumper	Default 1–2 (V1P8_ADC_VREF)/2-3 (J22 connector input voltage)
J18	ADC_REFP1 Selection Jumper	Default 1–2 (V1P8_ADC_VREF)/2-3 (J22 connector input voltage)
J20	ADC_DN0 Selection Jumper	Default 1–2 (POT input)/2-3 (J22 connector input voltage)
J21	ADC_DP0 Selection Jumper	
J11, J12, J13, J14, J15, J16, J19, J23, J24, J25, J26, J27, J28, J29, J30, J34, J35, J36, J37, J38, J39, J41, J42, J43, J44, J45, J46, and J47	Current Measurement 2 Pins Header	—

3. Power Scheme

The CertusPro-NX Evaluation Board has most of on-board regulators powered by an external 12 V power. Refer to [Appendix A. CertusPro-NX Evaluation Board Schematics](#) to see the details of these power supply options. [Figure 3.1](#) shows the high-level power supply architecture of the board. [Table 3.1](#) shows the voltage options available for various VCCIO supplies.

The VCC_ADJ power supply is required for FMC connector according to the FMC standard protocol. You can set the power output level by changing the resistor R243 value. If this VCC_ADJ power level supplies to bank3, 4, 5, the maximum level cannot exceed 1.8 V.

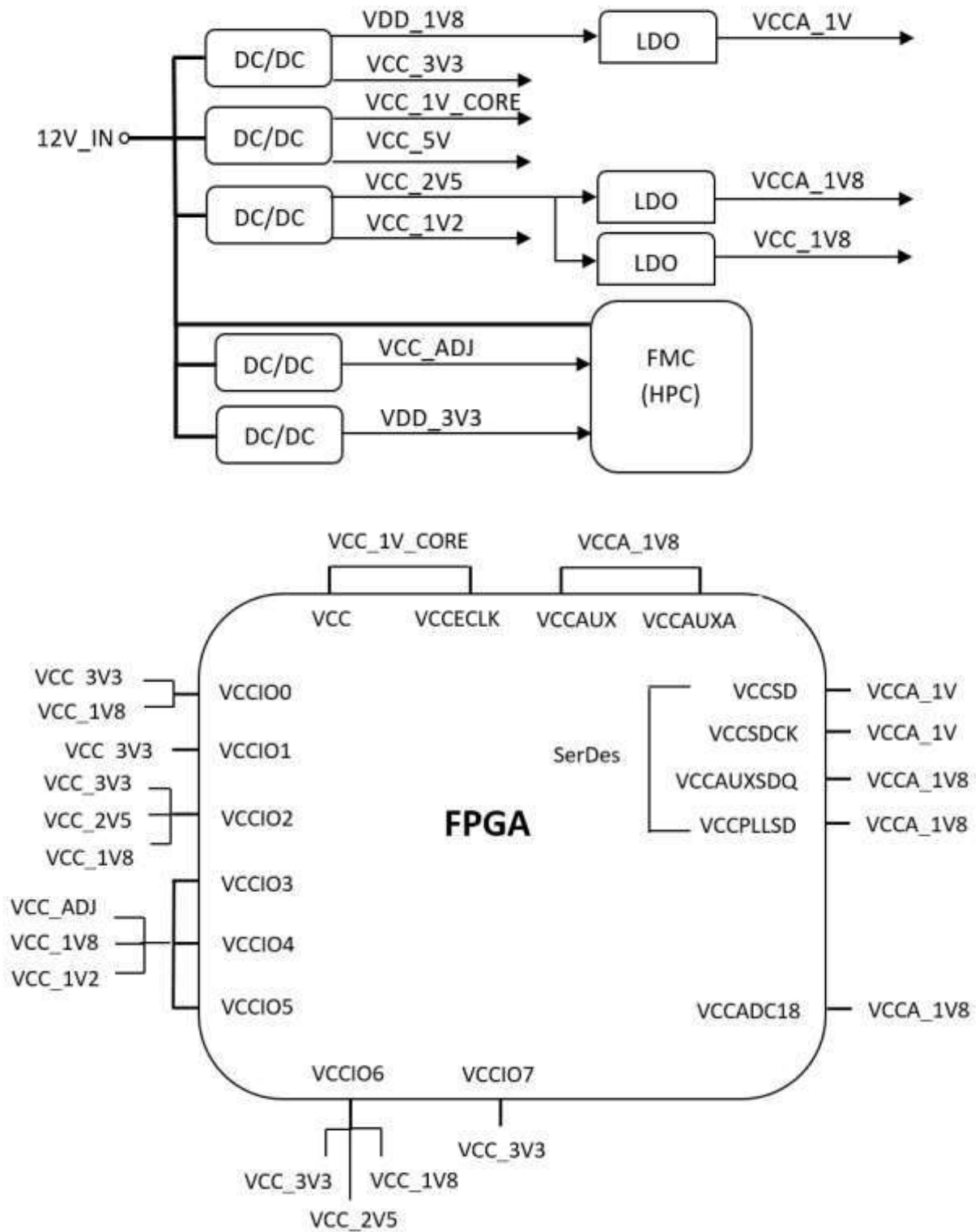

Figure 3.1. Board Power Scheme

Table 3.1. VCCIO Supply Options

VCCIO Bank	3.3 V	2.5 V	1.8 V	1.5 V	1.2 V	V-ADJ
VCCIO0	Selectable	—	Default	—	—	—
VCCIO1	Fixed	—	—	—	—	—
VCCIO2	Default	Selectable	Selectable	—	—	—
VCCIO3	—	—	Selectable	—	Selectable	Default
VCCIO4						
VCCIO5						
VCCIO6	Default	Selectable	Selectable	—	—	—
VCCIO7	Fixed	—	—	—	—	—

The CertusPro-NX Evaluation Boards provide status LEDs to provide a visual indication of power status (Table 3.2).

Table 3.2. Status LED Definition

LED Designator	Color	Description
D1	Green	J2 USB header plug in
D37	Green	1 V for CertusPro-NX core power on
D38	Green	12 V power on
D39	Green	1.8 V power on
D42	Green	1.2 V power on
D43	Green	5 V power on
D44	Green	2.5 V power on
D45	Green	3.3 V power on
D50	Green	1 V for CertusPro-NX device power on
D51	Green	1.8 V for CertusPro-NX device power on

4. Programming and I²C

The JTAG/SPI programming architecture and I²C interface of the CertusPro-NX Evaluation Board is shown in Figure 4.1.

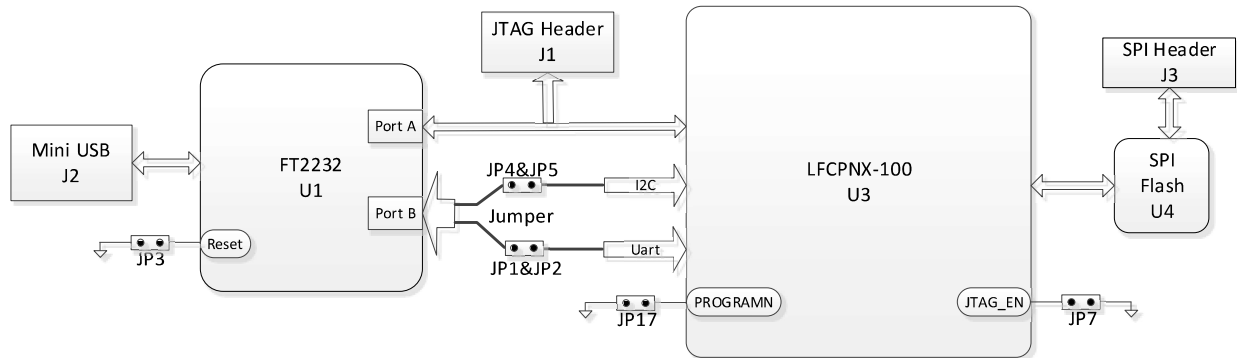

Figure 4.1. Configuration and I²C Architecture

4.1. JTAG Download Interface

The CertusPro-NX Evaluation Board has a built-in download controller for programming the CertusPro-NX device. It uses FT2232H part of Future Technology Devices International Ltd.(FTDI) to convert USB to JTAG. To use the built-in download cable, connect the USB cable from a PC with Radiant Programmer installed to the mini USB connector (J2) on the board. A USB-A to USB-B (Mini) cable is included in the CertusPro-NX Evaluation Board Kit. The USB hub on the PC detects the cable of the USB function on Port A, making the built-in cable available for use with the Radiant programming software.

4.2. Alternate JTAG Download Interface

J1 is a stand-alone 8-pin JTAG header used with an external Lattice download cable that can be available separately. When the FTDI part is disabled from the JTAG chain after the JP3 jumper is installed, the USB download cable can be attached to the board using J1 to interface with the CertusPro-NX device. For details on the connection between the USB download cable and J1, refer to [Programming Cables User Guide \(FPGA-UG-02042\)](#). J1 can also be used as a test point when the configuration from USB to JTAG is working. The JTAG connections are listed in [Table 4.1](#).

Table 4.1. JTAG Connections

J1 Pin Number	JTAG Signal Name	CertusPro-NX Ball Location for JTAG
1	VCC_3V3	—
2	TDO	M8
3	TDI	L9
4	—	—
5	—	—
6	TMS	L7
7	GND	—
8	TCK	M5

4.3. JTAG to MSPI Pass-through Interface

The download controller can also access the JTAG to MSPI pass-through circuit that allows the slave SPI Flash to be erased, programmed, and read with Radiant Programmer.

4.4. SPI Flash Device Selection in Programmer

The Flash device on this board is Micron MT25QU128ABA that powers up with 1.8 V (Figure 4.2).

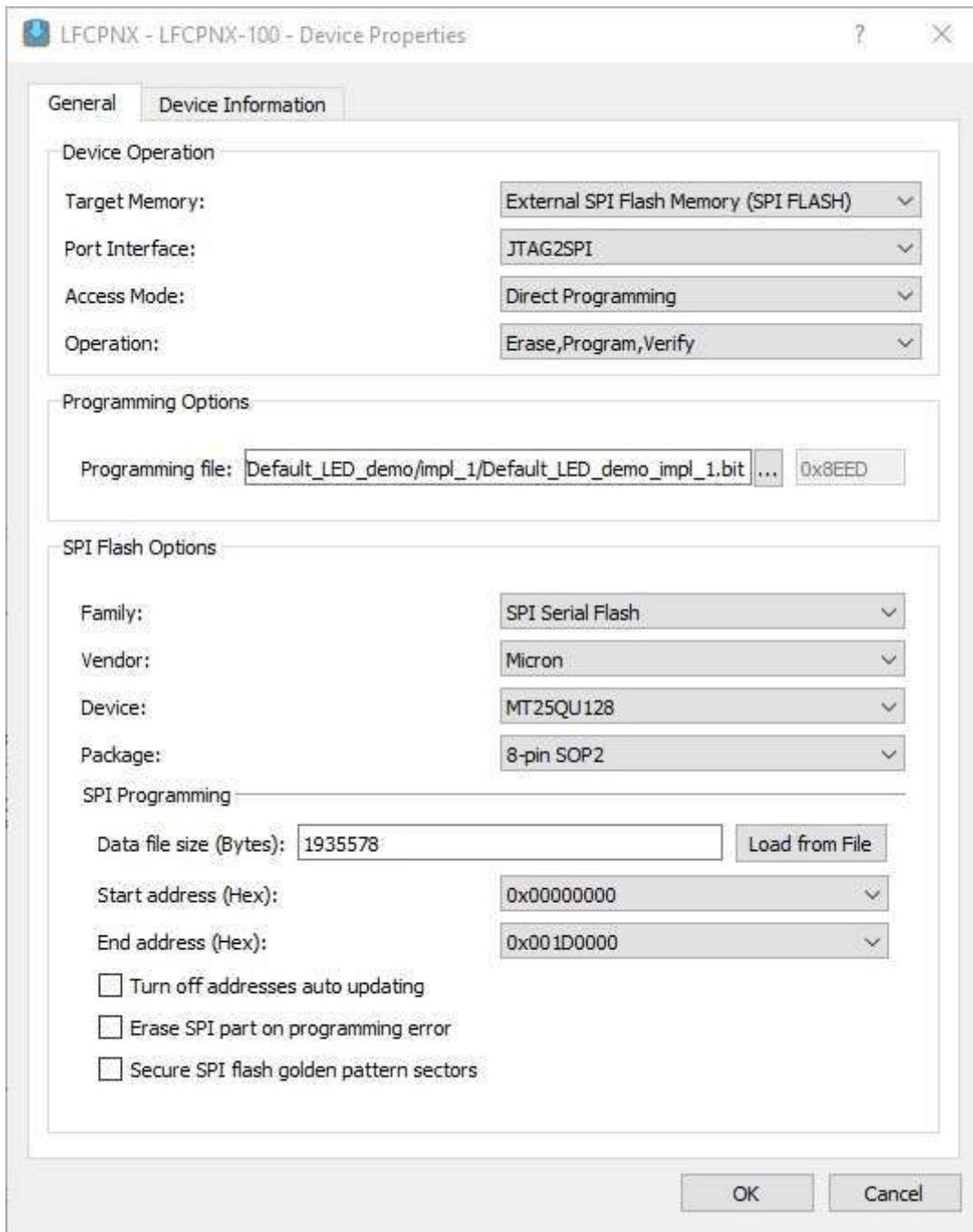

Figure 4.2. SPI Flash Operation Dialog

You may proceed with the Flash device programming by following the procedure described in [sysCONFIG User Guide for Nexus Platform \(FPGA-TN-02099\)](#).

4.5. Global Setting in Lattice Radiant software

The CertusPro-NX Evaluation Board has been downloaded with LED blinking project beforehand. Some **Global** settings in the **Device Constraint Editor** are configured. These settings are shown in [Figure 4.3](#) and [Figure 4.4](#).

- MASTER_SPI_PORT: SERIAL
- JTAG_PORT: ENABLE
- PROGRAMN_PORT: DISABLE
- MCCLK_FREQ: 112.5
- CONFIG_IOSLEW: MEDIUM
- Bank0(V): 1.8
- Bank1(V): 3.3
- Bank2(V): 3.3
- Bank3(V): 1.8
- Bank4(V): 1.8
- Bank5(V): 1.8
- Bank6(V): 3.3
- Bank7(V): 3.3

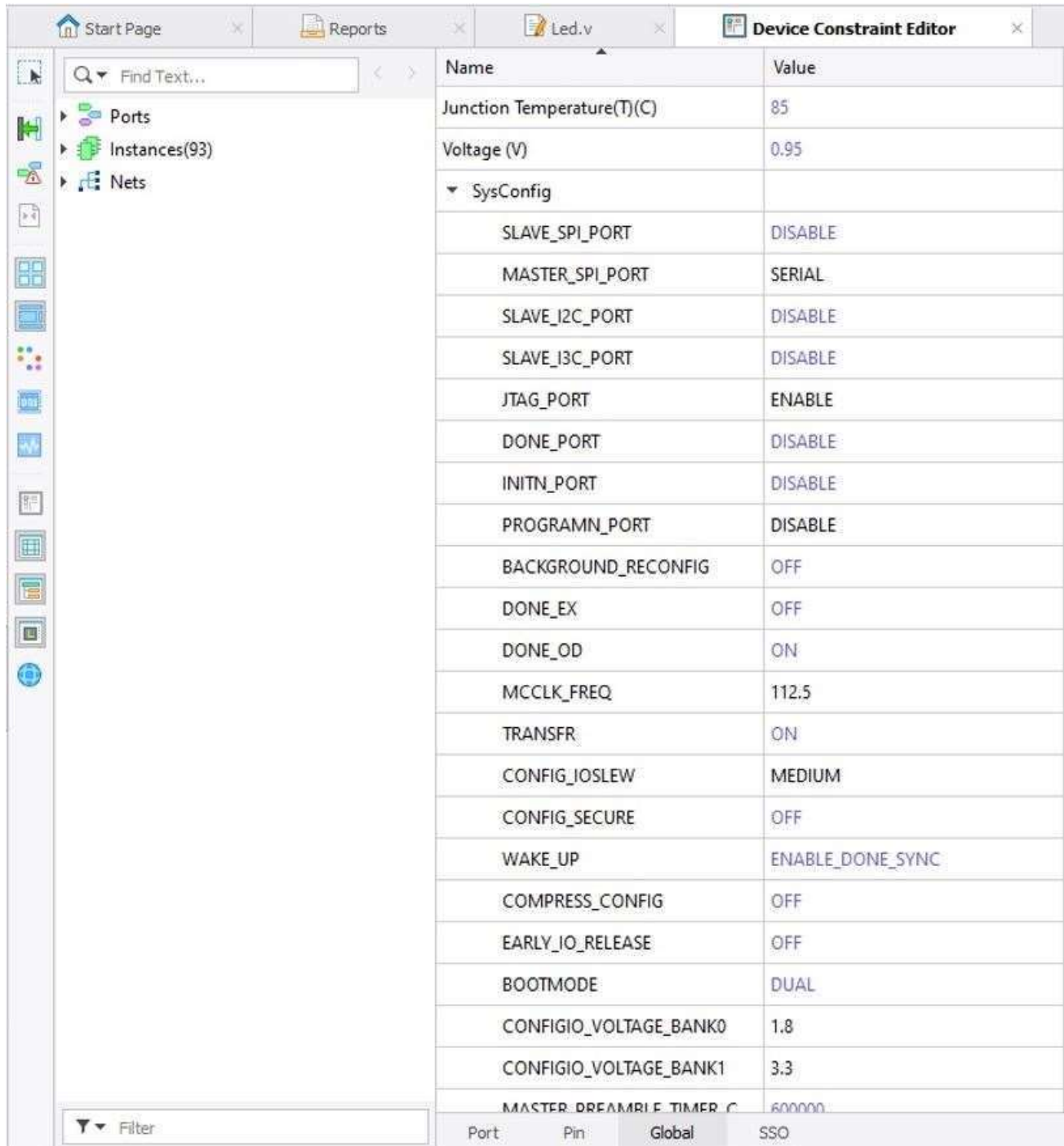

The screenshot shows the 'Device Constraint Editor' window with a search bar and a tree view on the left. The main area displays a table of global settings. The table has two columns: 'Name' and 'Value'. The settings include Junction Temperature, Voltage, and various SysConfig parameters like SLAVE_SPI_PORT, MASTER_SPI_PORT, JTAG_PORT, etc.

Name	Value
Junction Temperature(T)(C)	85
Voltage (V)	0.95
▼ SysConfig	
SLAVE_SPI_PORT	DISABLE
MASTER_SPI_PORT	SERIAL
SLAVE_I2C_PORT	DISABLE
SLAVE_I3C_PORT	DISABLE
JTAG_PORT	ENABLE
DONE_PORT	DISABLE
INITN_PORT	DISABLE
PROGRAMN_PORT	DISABLE
BACKGROUND_RECONFIG	OFF
DONE_EX	OFF
DONE_OD	ON
MCCLK_FREQ	112.5
TRANSFR	ON
CONFIG_IOSLEW	MEDIUM
CONFIG_SECURE	OFF
WAKE_UP	ENABLE_DONE_SYNC
COMPRESS_CONFIG	OFF
EARLY_IO_RELEASE	OFF
BOOTMODE	DUAL
CONFIGIO_VOLTAGE_BANK0	1.8
CONFIGIO_VOLTAGE_BANK1	3.3
MASTER_DREAMBLE_TIMER_C	600000

At the bottom of the table, there are tabs for 'Port', 'Pin', 'Global', and 'SSO'. The 'Global' tab is currently selected.

Figure 4.3. Global Setting (1)

Start Page		Reports	Led.v	Device Constraint Editor
Find Text...				
Ports	Instances(93)	Nets	Name	Value
			usercode	oooooooooooooooooooooooooooooooo
			Unique Id	0000
			Derating	
			Core	NOMINAL
			VCCIO	
			bank 0	NOMINAL
			bank 1	NOMINAL
			bank 2	NOMINAL
			bank 3	NOMINAL
			bank 4	NOMINAL
			bank 5	NOMINAL
			bank 6	NOMINAL
			bank 7	NOMINAL
			Bank VCCIO	
			Bank0(V)	1.8
			Bank1(V)	3.3
			Bank2(V)	3.3
			Bank3(V)	1.8
			Bank4(V)	1.8
			Bank5(V)	1.8
			Bank6(V)	3.3
			Bank7(V)	3.3
			Global Set/Reset Net	
			Use Primary Net	
			Vref Locate	
Filter			Port	Pin
			Global	SSO

Figure 4.4. Global Setting (2)

4.6. Other JTAG Configuration Pins

The CertusPro-NX Evaluation Board provides test points for other JTAG configuration pins as shown in [Table 4.2](#).

Table 4.2. Other JTAG Signals

Signal Name	CertusPro-NX Ball Location	Test Point	Push Button
PROGRAMN	G4	PROGRAMN	SW2
INITN	G2	INITN	—
DONE	G5	DONE	—
JTAG_EN	K1	—	—

- **INITN:** Open drain pin. This signal is driven to LOW when the configuration sequence is started, indicating the device is in initialization state. At this moment, the LED (D4) is lighted with red color. This signal is released after initialization is completed, and the configuration download starts.
- **DONE:** Open drain pin. This signal is driven to LOW during configuration time. This signal releasing indicates the device has completed configuration. At this moment, the LED (D5) is lighted with green color.

For more information on CertusPro-NX JTAG and SPI programming, refer to [sysCONFIG User Guide for Nexus Platform \(FPGA-TN-02099\)](#).

5. CertusPro-NX Clock Sources

The CertusPro-NX Evaluation Board has seven options for the CertusPro-NX clock sources, as shown in [Table 5.1](#).

Table 5.1. Clock Sources

Clock Frequency (MHz)	Signal Name	CertusPro-NX Ball Location	Clock Source	Comments
12	12_MHz	R4	X1	JP6 is installed. JP3 is removed. The USB cable is connected to PC.
Optional	CLOCK_100MHZ_P/N	F20/ E20	X2	JP11 is removed or output pin N24 should be "1" or "HiZ". Not installed on current board.
125	125_MHZ	N25	X3	JP15 is removed or output pin J23 should be "1" or "HiZ".
Optional	RESV_CLOCK	R6	X4 (Uninstalled)	JP18 is removed or output pin R7 should be "1" or "HiZ".
Optional	CLOCK_161MHZ_P/N	C14/ D13	U27	JP16 is removed or output pin R8 should be "1" or "HiZ". Not installed on current board.
Optional	FMC_GBTCLK0_M2C_P/N	D11/E11	J48	FMC SerDes reference clock 0 is located on the FMC input pin D4/D5.
Optional	FMC_GBTCLK1_M2C_P/N	E10/D9	J48	FMC SerDes reference clock 1 is located on the FMC input pin B20/B21.

The CertusPro-NX Evaluation Board also has one flexible clock source to support various SerDes protocol. The signal name is SMA_SDQ0_REFCLK_P/N. This clock owns a pair of SMA connectors (SMA1, SMA2). You can input your desired clock frequency with SMA cables to CertusPro-NX FPGA pin D11/E11. FMC SerDes reference clock 0 and SMA clock share the same FPGA clock input pin, so only one clock resource can be accessed at the same time.

SerDes reference clock signals, SDQ0_REFCLK_P/N and SDQ1_REFCLK_P/N, only support HCSL mode. The clock resources, X2 and U27, are not installed on the board. As an alternative solution to the SerDes reference clock input, SMA1 and SMA2 connectors can be used to input a clock with flexible frequency for the SerDes evaluation. Resistors R260 and R261 need to be installed when using the SMA clock.

X2 and U27 can be installed with the HCSL clock, if needed. HCSL clock should be connected to FPGA using DC coupling mode. Terminal resistor locations are reserved on the board.

6. Control Buses – I²C, UART, and SPI

This section describes the topology of the various configuration and communication buses.

6.1. I²C Topology

The CertusPro-NX Evaluation Board uses the I²C bus to support CertusPro-NX configuration. The I²C bus has the signal names SCL and SDA. When the jumpers (JP4 and JP5) are closed, the I²C bus is connected to a dedicated CertusPro-NX GPIO bank 1. I²C and UART share the same output port B on FTDI chip. Refer to [Figure 4.1](#) for the topology diagram. The I²C connections are summarized in [Table 6.1](#).

Table 6.1. I²C Bus Connections

Signal Name	CertusPro-NX Ball Location	FTDI Chip Ball Location	Jumper
SCL	M7	38	JP4
SDA	M6	39&40	JP5

6.2. UART Topology

The board provides one UART communication interface by providing a flexible connection between the CertusPro-NX device and FTDI chip. Close the two jumpers, JP1 and JP2, to connect to two general-purpose I/O in Bank 1, as shown in [Table 6.2](#). This UART is alternative with I²C bus by setting FTDI configuration.

Table 6.2. UART Bus Connections

Signal Name	CertusPro-NX Ball Location	FTDI Chip Ball Location	Jumper
TXD_UART	L2	38	JP1
RXD_UART	L1	39	JP2

6.3. SPI Topology

6.3.1. SPI Configuration

One of the major functions of SPI connections on the board is to support CertusPro-NX configuration from the SPI Flash or the Parallel Configuration Header (J3), as shown in [Table 6.3](#). The CertusPro-NX Evaluation Board can support both Master SPI (MSPI) and Slave SPI (SSPI) modes for CertusPro-NX configuration.

Table 6.3. SPI Bus Connections

Signal Name	CertusPro-NX Ball	Parallel Configuration Header Pin
SPI_MCLK	G6	12
DQ0_MOSI	H7	5
DQ1_MISO	H6	7
CSSPIN	G7	8
DQ2	K5	11
DQ3	H4	9
MCSNO	H3	3

7. LEDs and Switches

This section describes the CertusPro-NX Evaluation Board LEDs and switches that can be used in demo and customer designs.

7.1. DIP Switch

Eight CertusPro-NX pins are connected to the DIP switch (SW3) to allow manual actuating input to the FPGA. One side of each switch is connected to GPIOs within bank 0, and is pulled up through 4.7 kΩ resistors. The other side is grounded. The designated pins are connected as shown in [Table 7.1](#).

Table 7.1. DIP Switch Signals

Signal Name	CertusPro-NX Ball Location	CertusPro-NX Bank
DIP_SW1	K8	0
DIP_SW2	K7	0
DIP_SW3	K6	0
DIP_SW4	K4	0
DIP_SW5	K3	0
DIP_SW6	K2	0
DIP_SW7	J7	0
DIP_SW8	J6	0

7.2. General Purpose Push Buttons

The CertusPro-NX Evaluation Board provides four push button switches, SW1, SW2, SW4 and SW5, for demo and user applications. One of the buttons is pre-defined functional pin, and the other three are generic pins. Pressing these buttons drives a logic level “0” to the corresponding I/O pins. The designated pins are connected as shown in [Table 7.2](#).

Table 7.2. Push Button Switch Signals

Signal Name	CertusPro-NX Ball Location	Push Button Reference	Logic Level at Button Pressed
PROGRAMN	G4	SW2	0
PUSHBUTTON1	J5	SW1	0
PUSHBUTTON2	J2	SW4	0
PUSHBUTTON3	J3	SW5	0

For more information on PROGRAMN, refer to [sysCONFIG User Guide for Nexus Platform \(FPGA-TN-02099\)](#). SW2, SW4, and SW5 can be used as generic input.

7.3. General Purpose LEDs

The CertusPro-NX Evaluation Board provides 24 LEDs that are connected to I/O within Bank 1. The LEDs are lighted with green, yellow, red color when the output is driven LOW. The designated pins are connected as shown in [Table 7.3](#).

Table 7.3. General Purpose LED Signals

Signal Name	CertusPro-NX Ball Location	CertusPro-NX Bank/Color
LED_0	N5	1/Green
LED_1	N6	1/Green
LED_2	N7	1/Green
LED_3	N8	1/Green
LED_4	L6	1/Green
LED_5	N9	1/Green
LED_6	L8	1/Green
LED_7	M9	1/Green
LED_8	N1	1/Yellow
LED_9	N2	1/Yellow
LED_10	N3	1/Yellow
LED_11	M1	1/Yellow
LED_12	M2	1/Yellow
LED_13	M3	1/Yellow
LED_14	L3	1/Yellow
LED_15	N4	1/Yellow
LED_16	T4	1/Red
LED_17	T5	1/Red
LED_18	T6	1/Red
LED_19	T7	1/Red
LED_20	U8	1/Red
LED_21	T8	1/Red
LED_22	R9	1/Red
LED_23	P9	1/Red

8. Headers/Connectors and CertusPro-NX Device Ball Mapping

This section describes the CertusPro-NX Evaluation Board headers/connectors and ball mapping.

8.1. SMA Header

Table 8.1. SMA Header Connections

SMA Designator	Signal Name	CertusPro-NX Ball Location
27G_SMA1	SMA_SD4_RXD_P	B20
27G_SMA2	SMA_SD4_RXD_N	B19
27G_SMA3	SMA_SD4_TXD_P	A18
27G_SMA4	SMA_SD4_TXD_N	A17
27G_SMA5	SMA_SD5_RXD_P	C16
27G_SMA6	SMA_SD5_RXD_N	B16
27G_SMA7	SMA_SD5_TXD_P	A15
27G_SMA8	SMA_SD5_TXD_N	A14
27G_SMA9	SMA_SD6_RXD_P	B13
27G_SMA10	SMA_SD6_RXD_N	C12
27G_SMA11	SMA_SD6_TXD_P	A12
27G_SMA12	SMA_SD6_TXD_N	A11
27G_SMA13	SMA_SD7_RXD_P	B10
27G_SMA14	SMA_SD7_RXD_N	C10
27G_SMA15	SMA_SD7_TXD_P	A9
27G_SMA16	SMA_SD7_TXD_N	A8

8.2. FMC Connector

Table 8.2. HPC Pin Connections

J48 Pin Name	Signal Name	CertusPro-NX Ball Location
A2	FMC_SD1_RXD_P	E24
A3	FMC_SD1_RXD_N	D25
A6	FMC_SD2_RXD_P	C24
A7	FMC_SD2_RXD_N	B23
A10	FMC_SD3_RXD_P	C21
A11	FMC_SD3_RXD_N	C22
A22	FMC_SD1_TXD_P	C26
A23	FMC_SD1_TXD_N	B26
A26	FMC_SD2_TXD_P	A25
A27	FMC_SD2_TXD_N	A24
A30	FMC_SD3_TXD_P	A22
A31	FMC_SD3_TXD_N	A21
B1	FMC_RES1	R5
B20	FMC_GBTCLK1_M2C_P	E10
B21	FMC_GBTCLK1_M2C_N	D9
B40	FMC_RES0	P8
C2	FMC_SD0_TXD_P	F26
C3	FMC_SD0_TXD_N	E26
C6	FMC_SD0_RXD_P	G24

J48 Pin Name	Signal Name	CertusPro-NX Ball Location
C7	FMC_SD0_RXD_N	G25
C10	FMC_LA06_P	AD5
C11	FMC_LA06_N	AE5
C14	FMC_LA10_P	AA7
C15	FMC_LA10_N	Y7
C18	FMC_LA14_P	AA12
C19	FMC_LA14_N	AB12
C22	FMC_LA18_CLK_P	AD25
C23	FMC_LA18_CLK_N	AE25
C26	FMC_LA27_P	W11
C27	FMC_LA27_N	W10
C30	FMC_SCL	H22
C31	FMC_SDA	H23
C34	FMC_GA0	—
D1	FMC_PG_C2M	J22
D4	FMC_GBTCLK0_M2C_P	D11
D5	FMC_GBTCLK0_M2C_N	E11
D8	FMC_LA01_CLK_P	Y5
D9	FMC_LA01_CLK_N	AA5
D11	FMC_LA05_P	AF6
D12	FMC_LA05_N	AF5
D14	FMC_LA09_P	AD6
D15	FMC_LA09_N	AE6
D17	FMC_LA13_P	Y11
D18	FMC_LA13_N	AA11
D20	FMC_LA17_CLK_P	AB4
D21	FMC_LA17_CLK_N	AC4
D23	FMC_LA23_P	Y10
D24	FMC_LA23_N	AA10
D26	FMC_LA26_P	AB23
D27	FMC_LA26_N	AB24
D29	FMC_TCK	H20
D30	FMC_TDI	J24
D31	FMC_TDO	H26
D33	FMC_TMS	J26
D34	FMC_TRST_L	—
D35	FMC_GA1	—
E2	FMC_HA01_CLK_P	AA13
E3	FMC_HA01_CLK_N	AB13
E6	FMC_HA05_P	AD14
E7	FMC_HA05_N	AE14
E9	FMC_HA09_P	Y14
E10	FMC_HA09_N	AA14
E12	FMC_HA13_P	W13
E13	FMC_HA13_N	Y13
E15	FMC_HA16_P	AE22
E16	FMC_HA16_N	AE23
E18	FMC_HA20_P	AC13

J48 Pin Name	Signal Name	CertusPro-NX Ball Location
E19	FMC_HA20_N	AD13
F1	FMC_PG_M2C	J25
F4	FMC_HA00_CLK_P	AE13
F5	FMC_HA00_CLK_N	AE12
F7	FMC_HA04_P	AF15
F8	FMC_HA04_N	AF16
F10	FMC_HA08_P	W15
F11	FMC_HA08_N	W14
F13	FMC_HA12_P	AF21
F14	FMC_HA12_N	AF20
F16	FMC_HA15_P	AD20
F17	FMC_HA15_N	AC19
F19	FMC_HA19_P	Y18
F20	FMC_HA19_N	AA18
G2	FMC_CLK1_M2C_P	AB19
G3	FMC_CLK1_M2C_N	AB18
G6	FMC_LA00_CLK_P	AC12
G7	FMC_LA00_CLK_N	AD12
G9	FMC_LA03_P	AD4
G10	FMC_LA03_N	AE4
G12	FMC_LA08_P	Y6
G13	FMC_LA08_N	AA6
G15	FMC_LA12_P	AD10
G16	FMC_LA12_N	AE10
G18	FMC_LA16_P	AF12
G19	FMC_LA16_N	AF11
G21	FMC_LA20_P	AB9
G22	FMC_LA20_N	AC9
G24	FMC_LA22_P	AB22
G25	FMC_LA22_N	AA22
G27	FMC_LA25_P	AE24
G28	FMC_LA25_N	AF24
G30	FMC_LA29_P	AB25
G31	FMC_LA29_N	AC24
G33	FMC_LA31_P	AC26
G34	FMC_LA31_N	AB26
G36	FMC_LA33_P	W22
G37	FMC_LA33_N	W21
H1	FMC_VREFA	AE3,W12,AB20
H2	FMC_PRSNT_M2C_L	H21
H4	FMC_CLK0_M2C_P	AD21
H5	FMC_CLK0_M2C_N	AE21
H7	FMC_LA02_P	AF4
H8	FMC_LA02_N	AF3
H10	FMC_LA04_P	AB6
H11	FMC_LA04_N	AC6
H13	FMC_LA07_P	AC7
H14	FMC_LA07_N	AB7

J48 Pin Name	Signal Name	CertusPro-NX Ball Location
H16	FMC_LA11_P	AF10
H17	FMC_LA11_N	AF9
H19	FMC_LA15_P	AD11
H20	FMC_LA15_N	AE11
H22	FMC_LA19_P	AD9
H23	FMC_LA19_N	AE9
H25	FMC_LA21_P	AC22
H26	FMC_LA21_N	AD23
H28	FMC_LA24_P	AE26
H29	FMC_LA24_N	AF25
H31	FMC_LA28_P	AC25
H32	FMC_LA28_N	AD26
H34	FMC_LA30_P	AA23
H35	FMC_LA30_N	AA24
H37	FMC_LA32_P	W25
H38	FMC_LA32_N	W26
J2	FMC_CLK3_M2C_P	AC21
J3	FMC_CLK3_M2C_N	AD22
J6	FMC_HA03_P	AF14
J7	FMC_HA03_N	AF13
J9	FMC_HA07_P	AB15
J10	FMC_HA07_N	AC15
J12	FMC_HA11_P	AF19
J13	FMC_HA11_N	AE19
J15	FMC_HA14_P	Y16
J16	FMC_HA14_N	W16
J18	FMC_HA18_P	AA17
J19	FMC_HA18_N	Y17
J21	FMC_HA22_P	V24
J22	FMC_HA22_N	V25
K4	FMC_CLK2_M2C_P	AB11
K5	FMC_CLK2_M2C_N	AC11
K7	FMC_HA02_P	AD15
K8	FMC_HA02_N	AE15
K10	FMC_HA06_P	AC18
K11	FMC_HA06_N	AD18
K13	FMC_HA10_P	AF22
K14	FMC_HA10_N	AF23
K16	FMC_HA17_CLK_P	W24
K17	FMC_HA17_CLK_N	W23
K19	FMC_HA21_P	W17
K20	FMC_HA21_N	W18
K22	FMC_HA23_P	U26
K23	FMC_HA23_N	V26

8.3. Parallel FMC Configuration Header

Table 8.3. Parallel FMC Configuration Header Pin Connections

J10 Pin Name	Signal Name	CertusPro-NX Ball Location
1	VCC_3V3	—
2	VCC_3V3	—
3	FMC_TCK	H20
4	FMC_PG_C2M	J22
5	FMC_PG_M2C	J25
6	FMC_TRST_L	—
7	FMC_TDI	J24
8	FMC_PRST_M2C_L	H21
9	FMC_TDO	H26
10	FMC_SCL	H22
11	GND	—
12	GND	—
13	FMC_TMS	J26
14	FMC_SDA	H23

8.4. Raspberry PI Board GPIO Header

The CertusPro-NX Evaluation Board provides a 40-pin receptacle, which is compatible with the GPIO header of Raspberry PI 2/3 serial models, or can be used for general purpose I/O.

Table 8.4. Raspberry PI header Pin Connections

JP14 Pin Name	Signal Name	CertusPro-NX Ball Location
1	VCC_3V3*	—
2	VCC_5V *	—
3	RASP_IO02	K26
4	VCC_5V*	—
5	RASP_IO03	L26
6	GND	—
7	RASP_IO04	K25
8	RASP_IO14	L25
9	GND	—
10	RASP_IO15	K24
11	RASP_IO17	L24
12	RASP_IO18	N26
13	RASP_IO27	J21
14	GND	—
15	RASP_IO22	L23
16	RASP_IO23	J20
17	VCC_3V3*	—
18	RASP_IO24	K21
19	RASP_IO10	J19
20	GND	—
21	RASP_IO09	K20
22	RASP_IO25	L22
23	RASP_IO11	M26

JP14 Pin Name	Signal Name	CertusPro-NX Ball Location
24	RASP_IO08	K19
25	GND	—
26	RASP_IO07	K18
27	RASP_ID_SD	P20
28	RASP_ID_SC	P19
29	RASP_IO05	L20
30	GND	—
31	RASP_IO06	L19
32	RASP_IO12	L21
33	RASP_IO13	N23
34	GND	—
35	RASP_IO19	N22
36	RASP_IO16	N19
37	RASP_IO26	N20
38	RASP_IO20	N21
39	GND	—
40	RASP_IO21	P18

***Note:** 3.3 V and 5 V provide the power to the Raspberry PI board when JP12 and JP13 are installed. When JP12 and JP13 are not installed, Raspberry PI needs its own 3.3 V and 5 V power.

When connecting directly to a Raspberry PI board, depending on the individual setup, an adapter may need to avoid mechanical interference between the two boards. A generic 40-pin (2×20), 100-mil spacing header extender serves this function. Alternately, the two boards can be connected by a length of ribbon cable with 2×20 connectors on either end.

8.5. External Flash Configuration Header

Table 8.5. SPI Flash Configuration Header Pin Connections

J3 Pin Name	Signal Name	CertusPro-NX Ball Location
1	PROGRAMN	G4
2	FLASH_CS	G7
3	MCSNO	H3
4	DONE	G5
5	DQ0_MOSI	H7
6	INITN	G2
7	DQ1_MISO	H6
8	CSSPIN	G7
9	DQ3	H4
10	VCCIO0_IN	—
11	DQ2	K5
12	SPI_MCLK	G6
13	GND	—
14	GND	—

8.6. ADC Test Header

Table 8.6. ADC Header Pin Connections

J22 Pin Name	Signal Name	CertusPro-NX Ball Location
1	GND	—
2	GND	—
3	J20 PIN-3	—
4	GND	—
5	J21 PIN-3	—
6	GND	—
7	GND	—
8	GND	—
9	—	AE1
10	GND	—
11	—	AD1
12	GND	—
13	GND	—
14	GND	—
15	VREF2_CON	—
16	GND	—
17	GND	—
18	GND	—
19	VREF1_CON	—
20	GND	—

8.7. PMOD Header

J4, J5, and J6 headers can be used as GPIO or as a connector to PMOD interface.

Table 8.7. PMOD Header Pin Connections

	Pin Name	Signal Name	CertusPro-NX Ball Location
J4	1	PMOD1_1	V7
	2	PMOD1_2	V6
	3	PMOD1_3	V5
	4	PMOD1_4	V4
	7	PMOD1_5	V8
	8	PMOD1_6	W7
	9	PMOD1_7	W6
	10	PMOD1_8	W5
J5	1	PMOD0_1	Y1
	2	PMOD0_2	W2
	3	PMOD0_3	V3
	4	PMOD0_4	V1
	7	PMOD0_5	Y2
	8	PMOD0_6	W3
	9	PMOD0_7	W1
	10	PMOD0_8	V2
J6	1	PMOD2_1	AA4
	2	PMOD2_2	AB3
	3	PMOD2_3	AA2
	4	PMOD2_4	AA1
	7	PMOD2_5	W4
	8	PMOD2_6	Y4
	9	PMOD2_7	AB2
	10	PMOD2_8	AB1

8.8. Through Hole Extended Area Header

Table 8.8. Through Hole Extended Area Header Pin Connections

Pin Name	Signal Name	CertusPro-NX Ball Location
GND6	GND	—
GND7	GND	—
GND8	GND	—
GND9	GND	—
GND10	GND	—
GND11	GND	—
1V2	VCC_1V2	—
1V8	VCC_1V8	—
2V5	VCC_2V5	—
3V3	VCC_3V3	—
5V	VCC_5V	—
ADJ	VCC_ADJ	—
GND12	GND	—
GND13	GND	—
GND14	GND	—
GND15	GND	—
GND16	GND	—
GND17	GND	—
TP_U3	EPS19_U3_N	U3
TP_U1	EPS18_U1_N	U1
TP_U18	EPS4_U18_N	U18
TP_T18	EPS5_T18_N	T18
TP_T23	EPS7_T23_N	T23
TP_V23_P	EPS24_V23_P	V23
TP_U2	EPS19_U2_P	U2
TP_T1	EPS18_T1_P	T1
TP_U19	EPS4_U19_P	U19
TP_T19	EPS5_T19_P	T19
TP_T24	EPS7_T24_P	T24
TP_V22_N	EPS24_V22_N	V22
GND18	GND	—
TP_T2	EPS17_T2_N	T2
TP_V18	EPS1_V18_P	V18
TP_T20	EPS6_T20_N	T20
TP_T26	EPS8_T26_P	T26
TP_U25	EPS2_U25_N	U25
TP_U6	EPS20_U6_P	U6
TP_T3	EPS17_T3_P	T3
TP_V19	EPS1_V19_N	V19
TP_T21	EPS6_T21_P	T21
TP_T25	EPS8_T25_N	T25
TP_U24	EPS2_U24_P	U24
TP_U7	EPS20_U7_N	U7
TP_H1	EPS16_H1_N	H1
TP_V20	EPS0_V20_P	V20

Pin Name	Signal Name	CertusPro-NX Ball Location
TP_R22	EPS10_R22_P	R22
TP_R25	EPS9_R25_P	R25
TP_U22	EPS3_U22_P	U22
TP_J1	EPS17_J1	J1
TP_H2	EPS16_H2_P	H2
TP_V21	EPS0_V21_N	V21
TP_T22	EPS10_T22_N	T22
TP_R26	EPS9_R26_N	R26
TP_U23	EPS3_U23_N	U23
TP_AE3_N	EPS21_AE3_N	AE3
TP_R18	EPS11_R18_N	R18
TP_P21	EPS13_P21_N	P21
TP_P25	EPS15_P25_N	P25
GND21	GND	—
TP_AB20_N	EPS23_AB20_N	AB20
TP_AD3_P	EPS21_AD3_P	AD3
TP_R19	EPS11_R19_P	R19
TP_P22	EPS13_P22_P	P22
TP_P26	EPS15_P26_P	P26
GND22	GND	—
TP_AC20_P	EPS23_AC20_P	AC20
TP_Y12_P	EPS22_Y12_P	Y12
TP_R20	EPS12_R20_P	R20
TP_P24	EPS14_P24_P	P24
GND19	GND	—
GND23	GND	—
GND25	GND	—
TP_W12_N	EPS22_W12_N	W12
TP_R21	EPS12_R21_N	R21
TP_P23	EPS14_P23_N	P23
GND20	GND	—
GND24	GND	—
GND26	GND	—

9. Software Requirements

The following software versions are required to develop designs for the CertusPro-NX Evaluation Board:

- Lattice Radiant Software 3.0 or later
- Lattice Radiant Programmer 3.0 or later

10. Storage and Handling

Static electricity can shorten the life span of electronic components. Observe these tips to prevent damage that can occur from electrostatic discharge:

- Use antistatic precautions such as operating on an antistatic mat and wearing an antistatic wristband.
- Store the development board in the provided packaging.
- Touch a metal USB housing to equalize voltage potential between you and the board.

11. Ordering Information

Table 11.1. Ordering Information

Description	Ordering Part Number	China RoHS Environment-Friendly Use Period (EFUP)
CertusPro-NX Evaluation Board	LFCPNX-EVN	

Appendix A. CertusPro-NX Evaluation Board Schematics

CertusPro-NX Evaluation Board	
Rev - B	
01 - Title Page	
02 - Block Diagram	
03 - USB Interface	
04 - Bank-0 Configuration	
05 - Bank-1 LEDs&JTAG	
06 - Bank-2 PMODs	
07 - Bank-3,4,5 FMC	
08 - HPC	
09 - Bank-6 Extended Bank	
10 - Bank-7 Raspberry PI	
11 - SerDes	
12 - ADC	
13 - Bank Power	
14 - Power Decoupling	
15 - Power Regulators	
16 - Ground	
17 - Power Block Diagram	



Lattice Semiconductor Applications
<http://www.latticesemi.com/Support>

Title Page	
Rev	Project
B	CertusPro-NX Evaluation Board
Date	Tuesday, March 15, 2022
Sheet	1 of 17

Figure A.1. Title Page

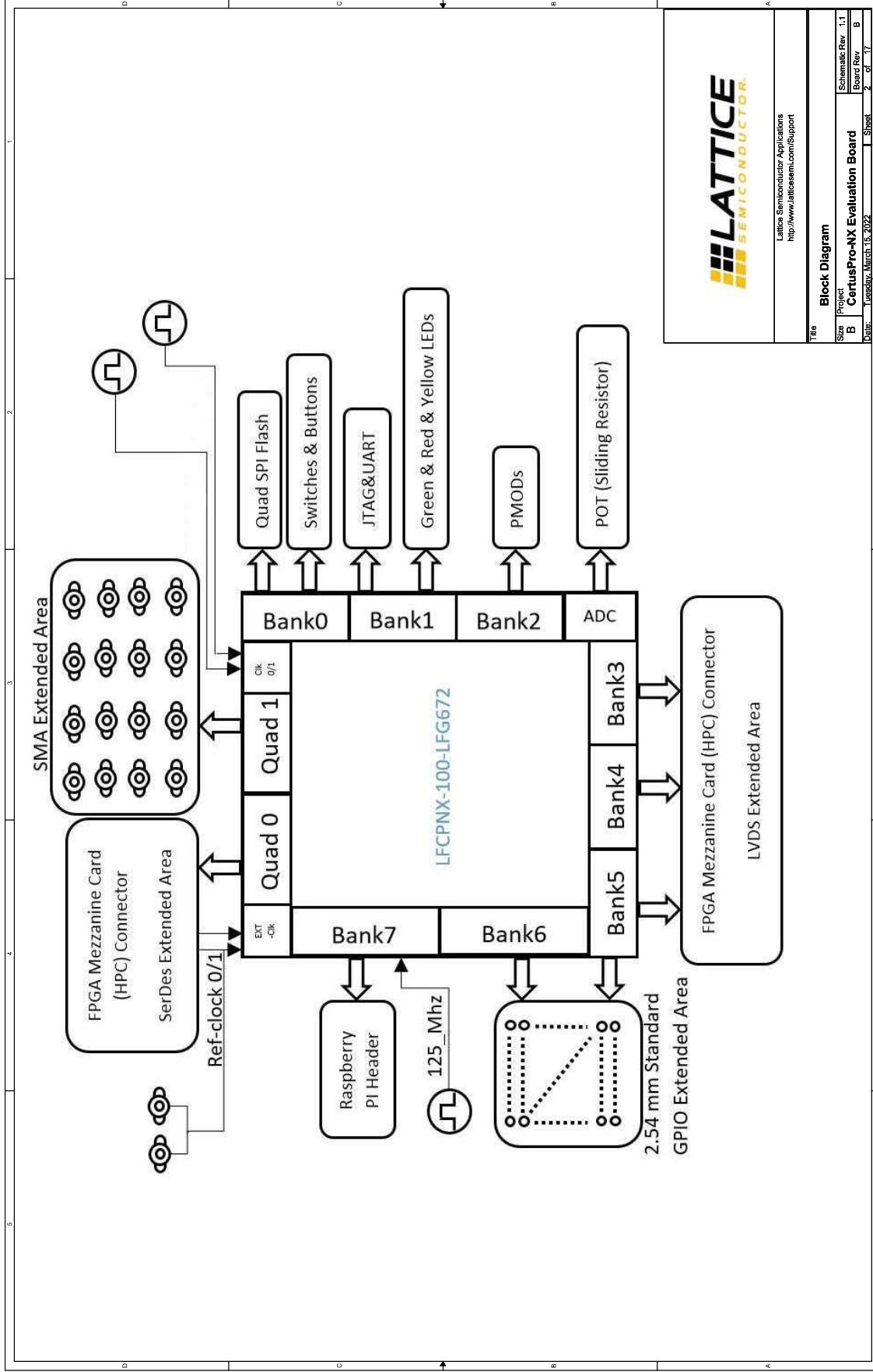

Figure A.2. Block Diagram

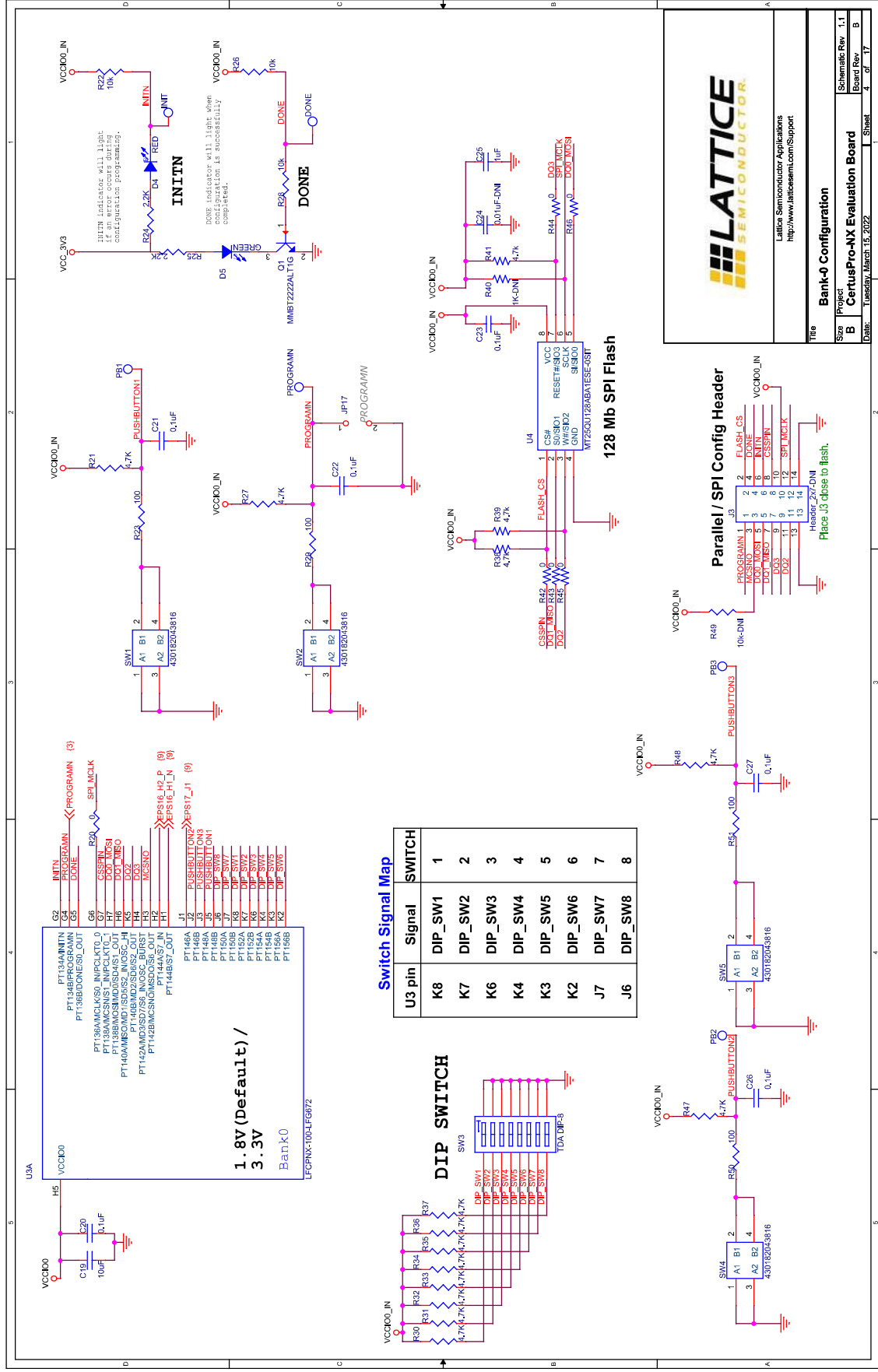

Figure A.4. Bank-0 Configuration

© 2021-2022 Lattice Semiconductor Corp. All Lattice trademarks, registered trademarks, patents, and disclaimers are as listed at www.latticesemi.com/legal. All other brand or product names are trademarks or registered trademarks of their respective holders. The specifications and information herein are subject to change without notice.

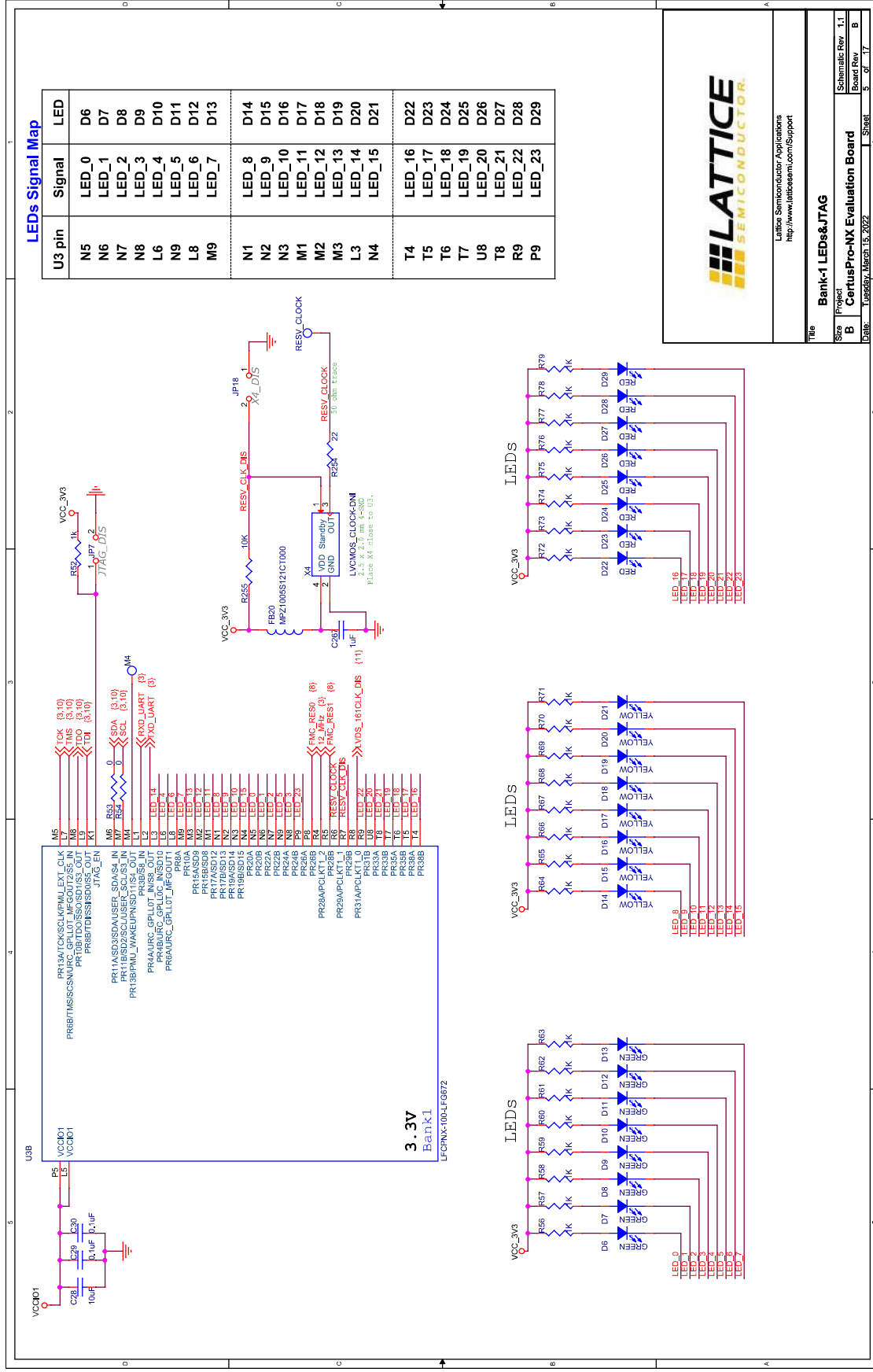

Figure A.5. Bank-1 LEDs & JTAG

© 2021-2022 Lattice Semiconductor Corp. All Lattice trademarks, registered trademarks, patents, and disclaimers are as listed at www.latticesemi.com/legal. All other brand or product names are trademarks or registered trademarks of their respective holders. The specifications and information herein are subject to change without notice.

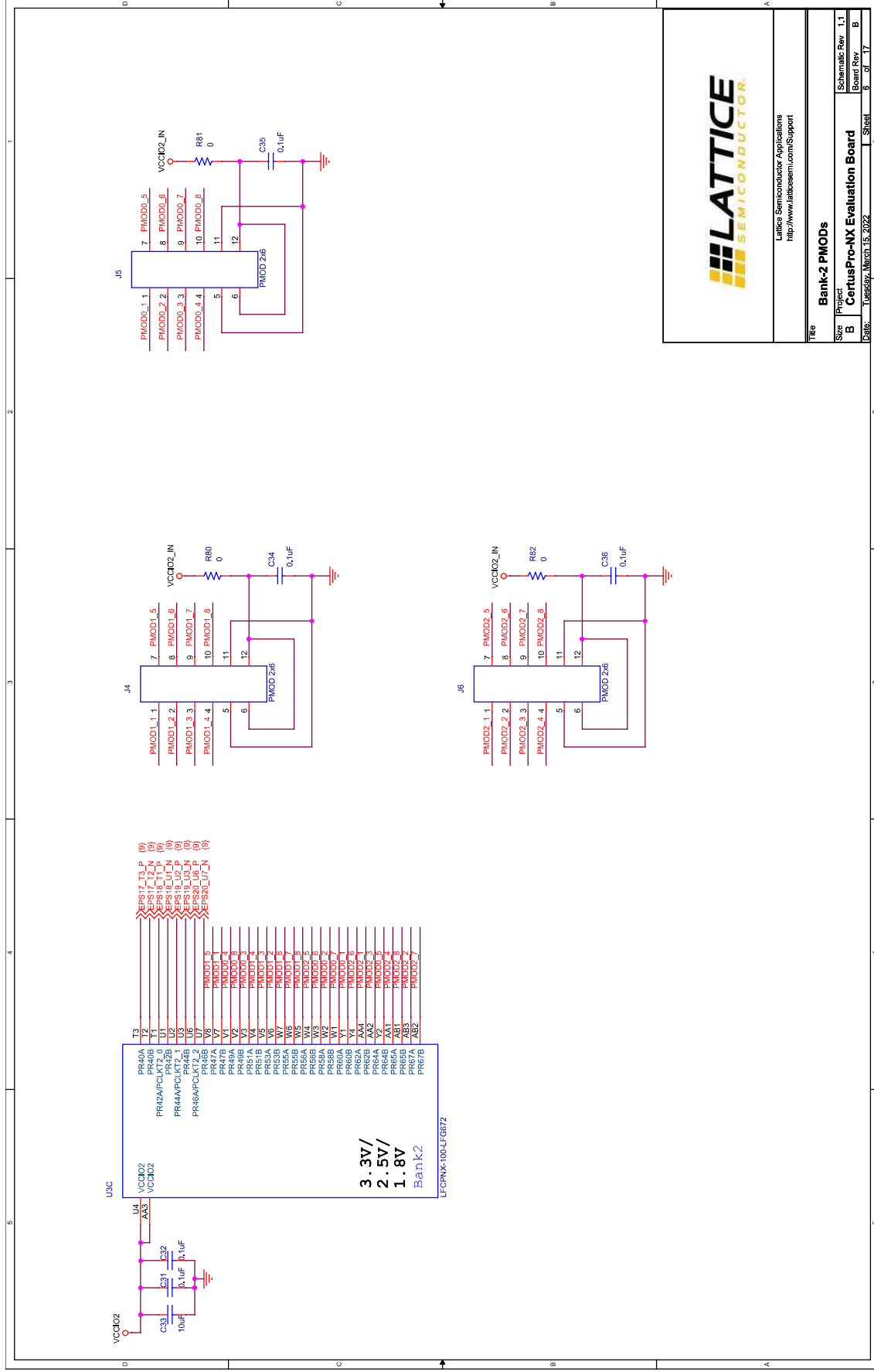
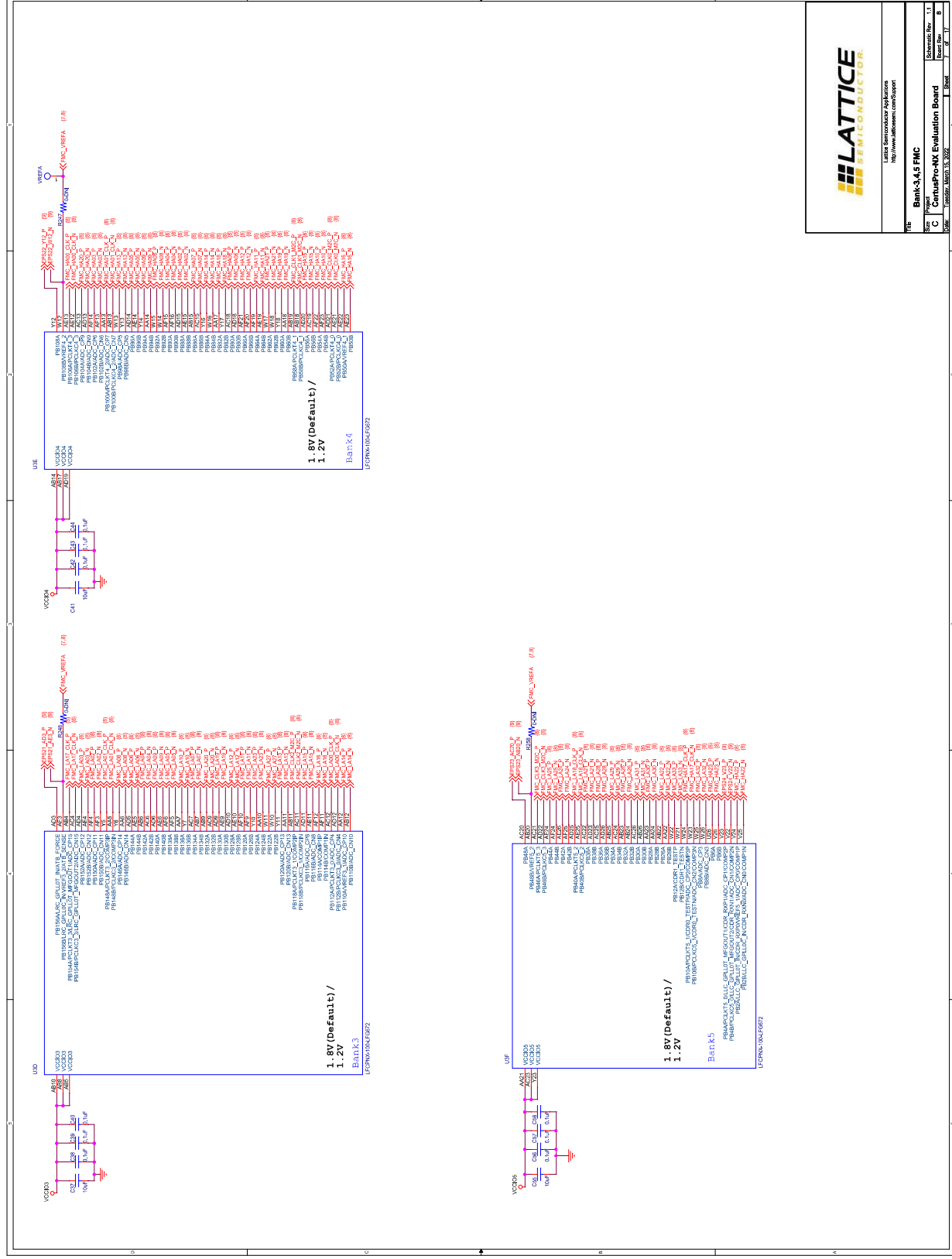

Figure A.6. Bank-2 PMODs



Lattice Semiconductor Application
http://www.lattice.com/support

Part: Bank-3,4,5 FMC

Doc: CertusPro-NX Evaluation Board

Date: Tuesday, March 15, 2022

Page: 1 of 17

Figure A.7. Bank-3,4,5 FMC

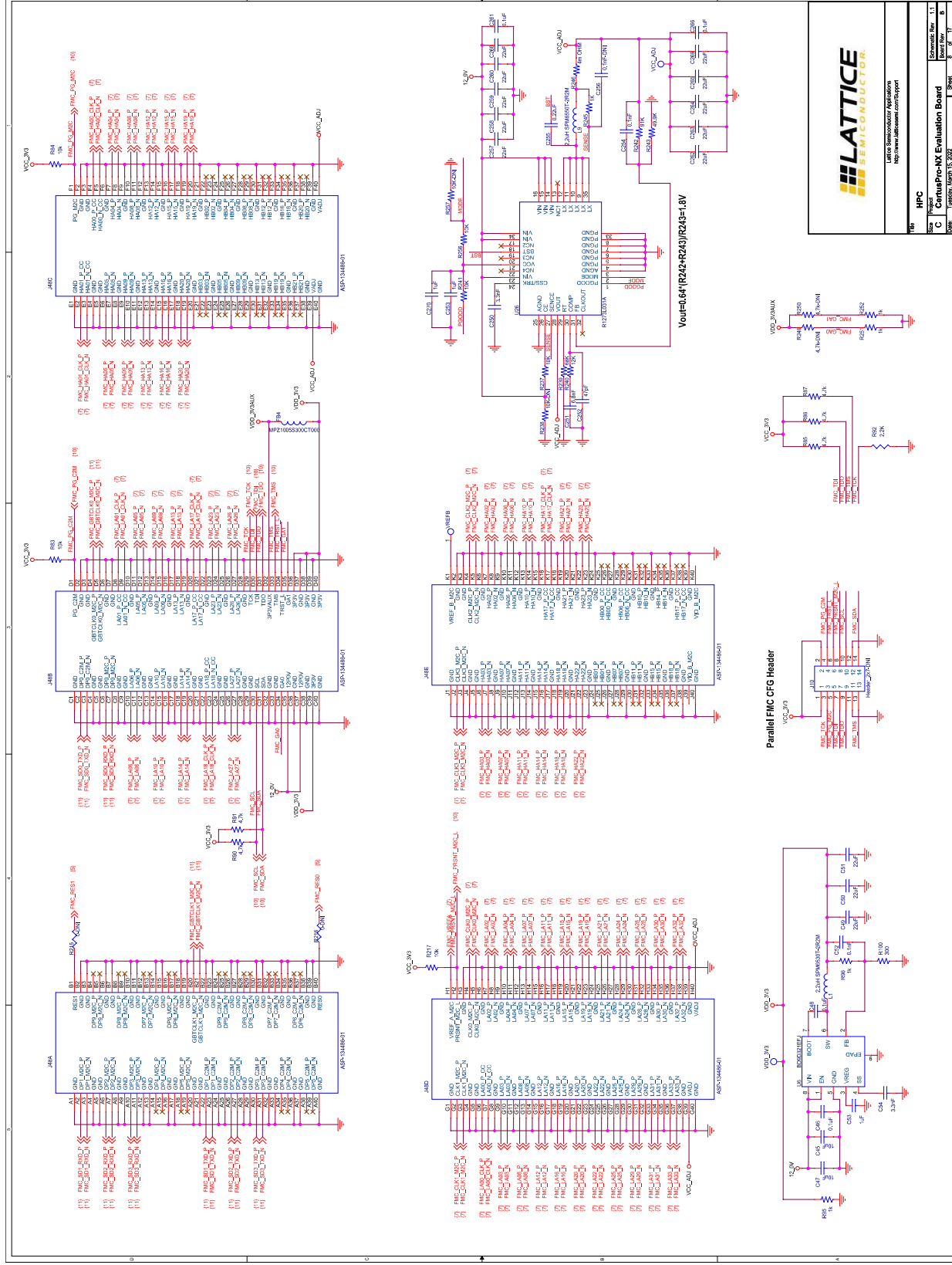

Figure A.8. HPC

© 2021-2022 Lattice Semiconductor Corp. All Lattice trademarks, registered trademarks, patents, and disclaimers are as listed at www.latticesemi.com/legal. All other brand or product names are trademarks or registered trademarks of their respective holders. The specifications and information herein are subject to change without notice.

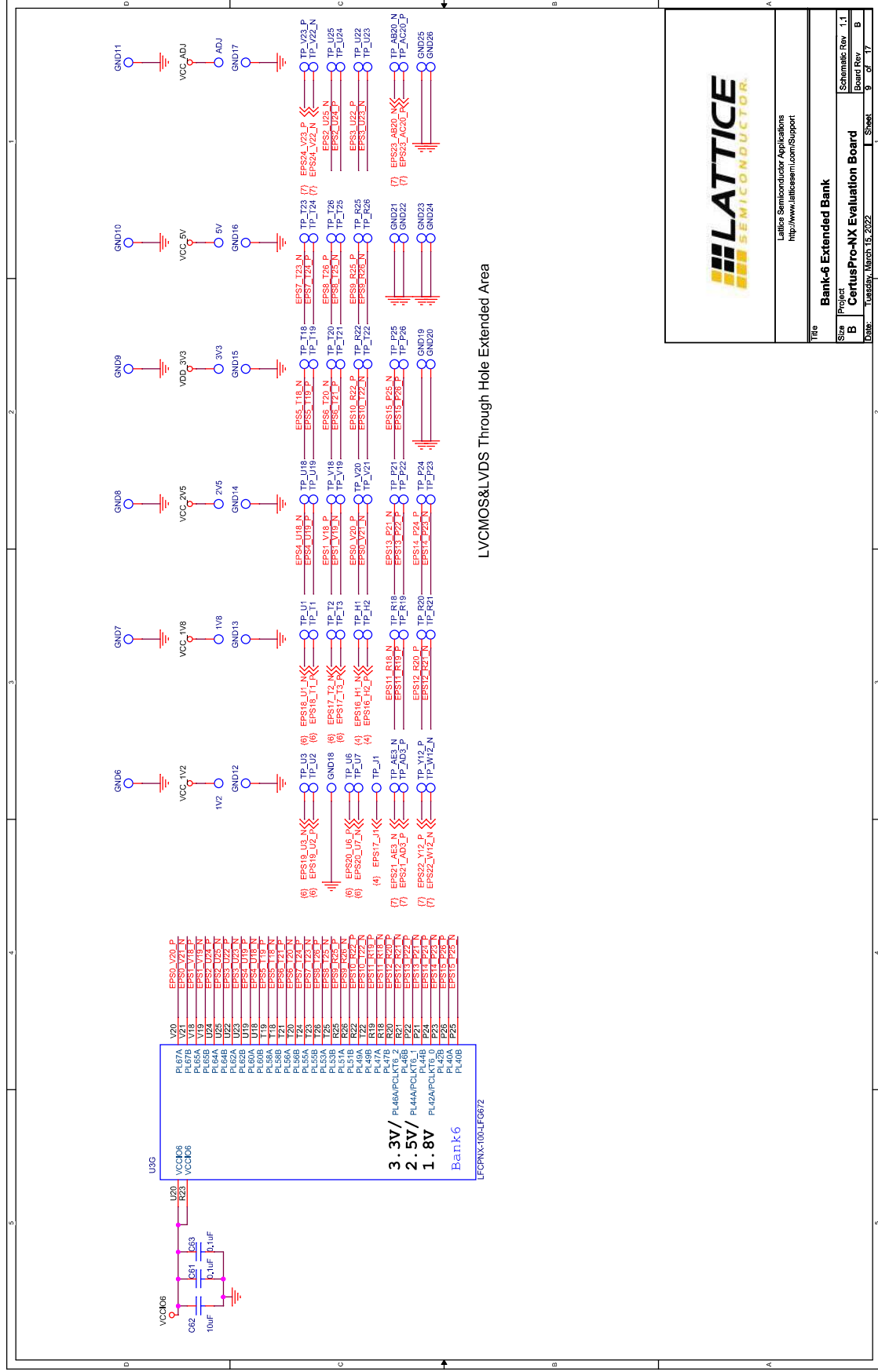

Figure A.9. Bank-6 Extended Bank

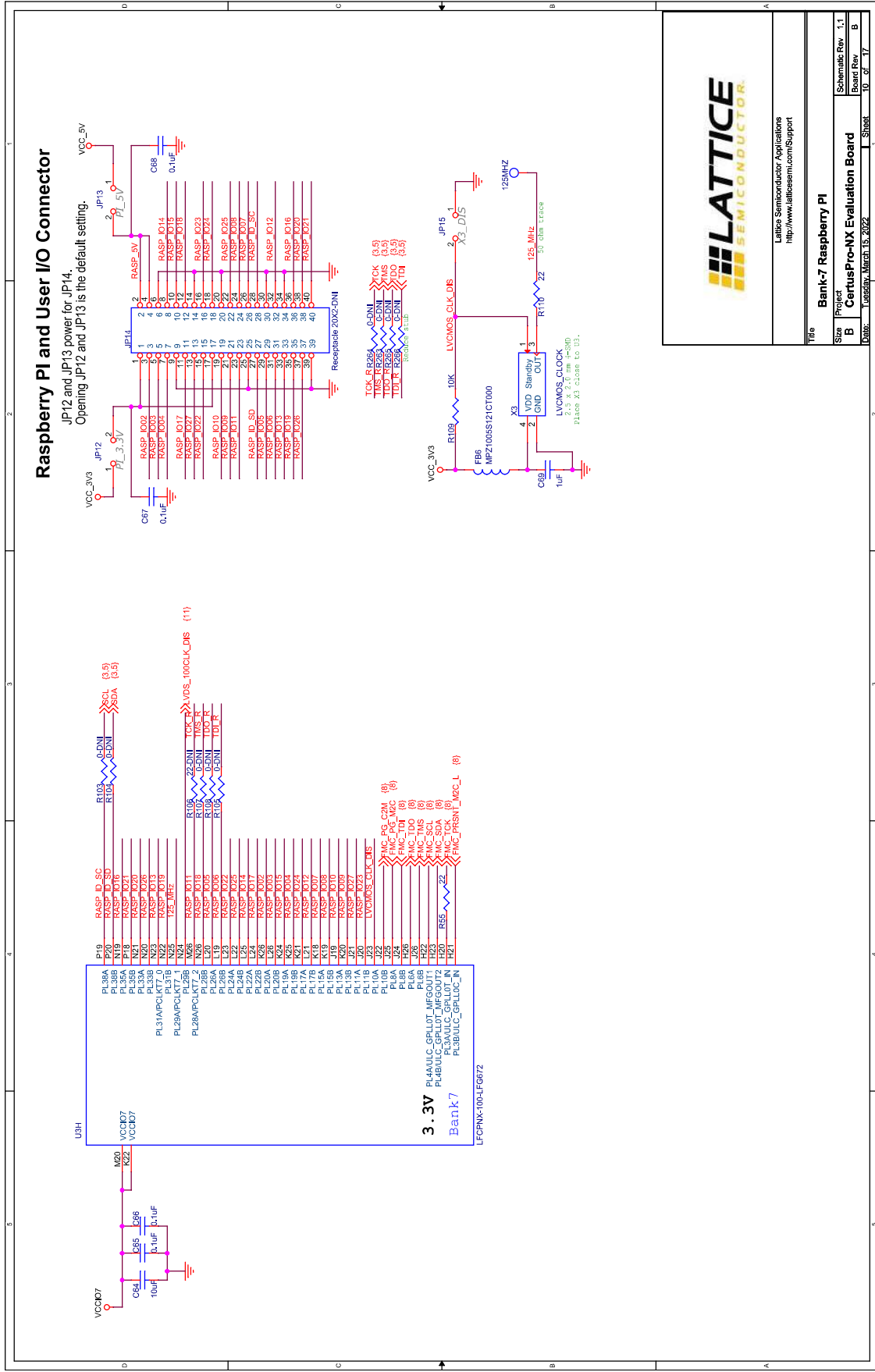

Figure A.10. Bank-7 Raspberry PI

© 2021-2022 Lattice Semiconductor Corp. All Lattice trademarks, registered trademarks, patents, and disclaimers are as listed at www.latticesemi.com/legal. All other brand or product names are trademarks or registered trademarks of their respective holders. The specifications and information herein are subject to change without notice.

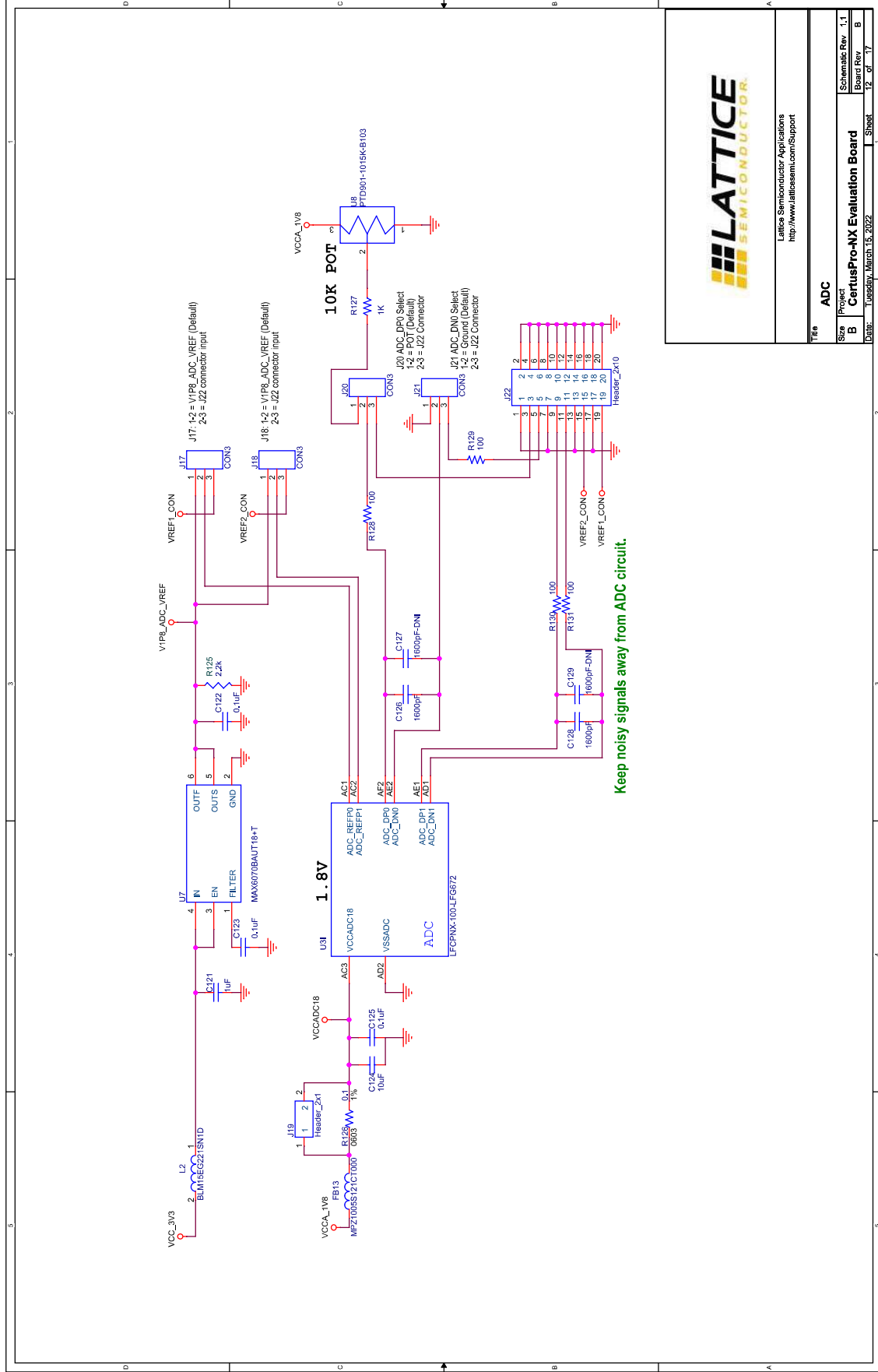

Figure A.12. ADC

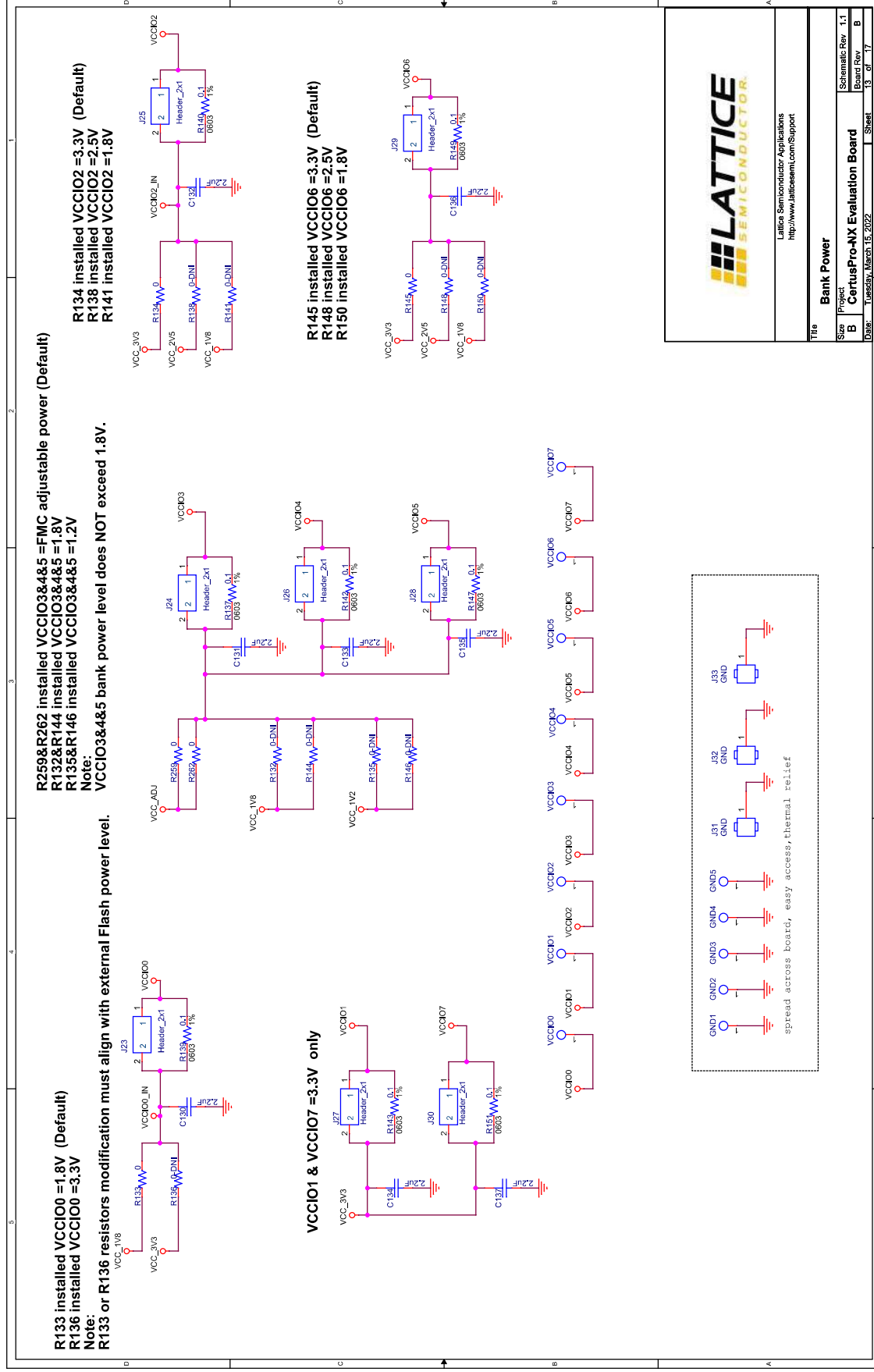

Figure A.13. Bank Power

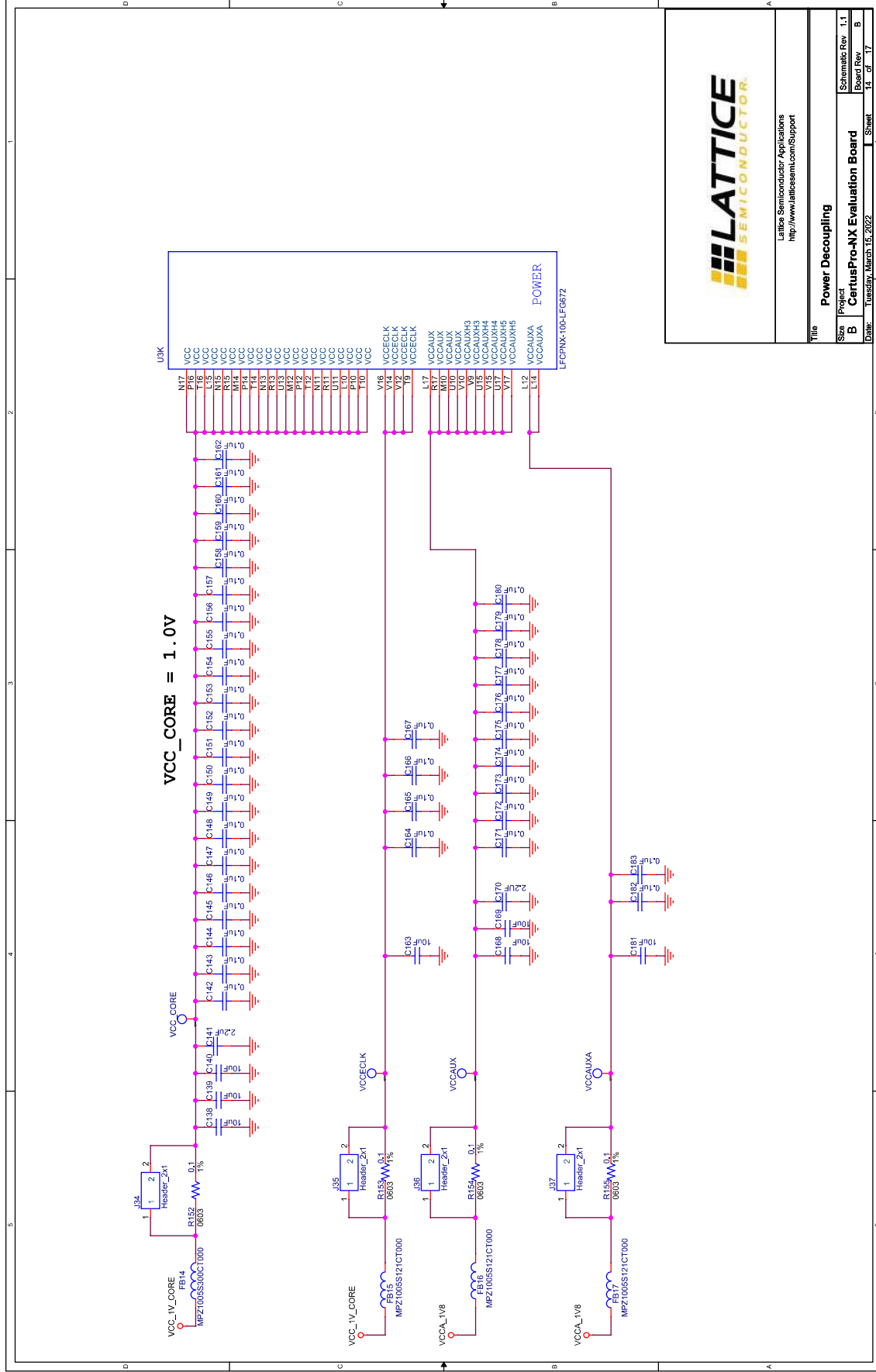

Figure A.14. Power Decoupling

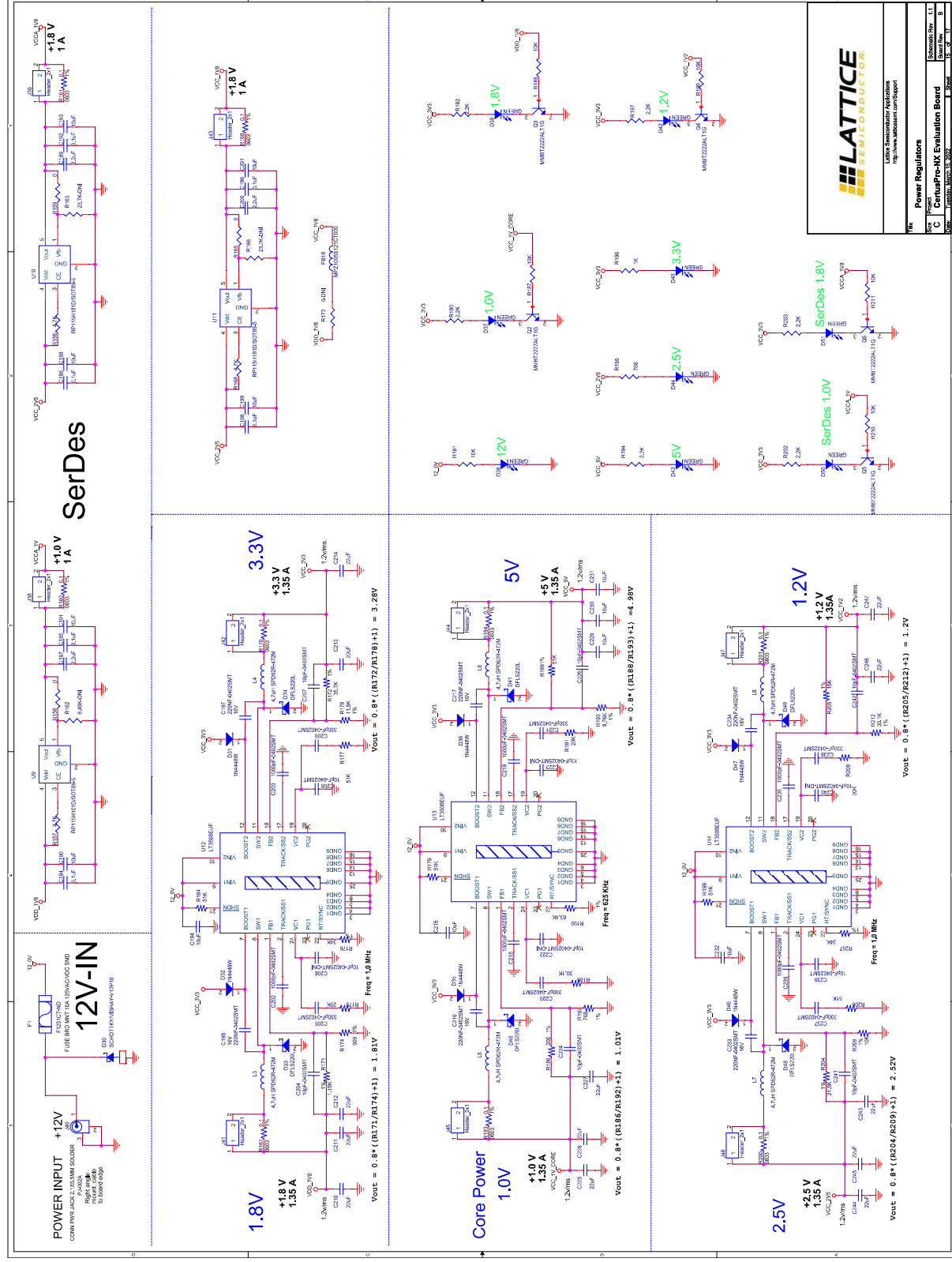

Figure A.15. Power Regulators

© 2021-2022 Lattice Semiconductor Corp. All Lattice trademarks, registered trademarks, patents, and disclaimers are as listed at www.latticesemi.com/legal.
All other brand or product names are trademarks or registered trademarks of their respective holders. The specifications and information herein are subject to change without notice.

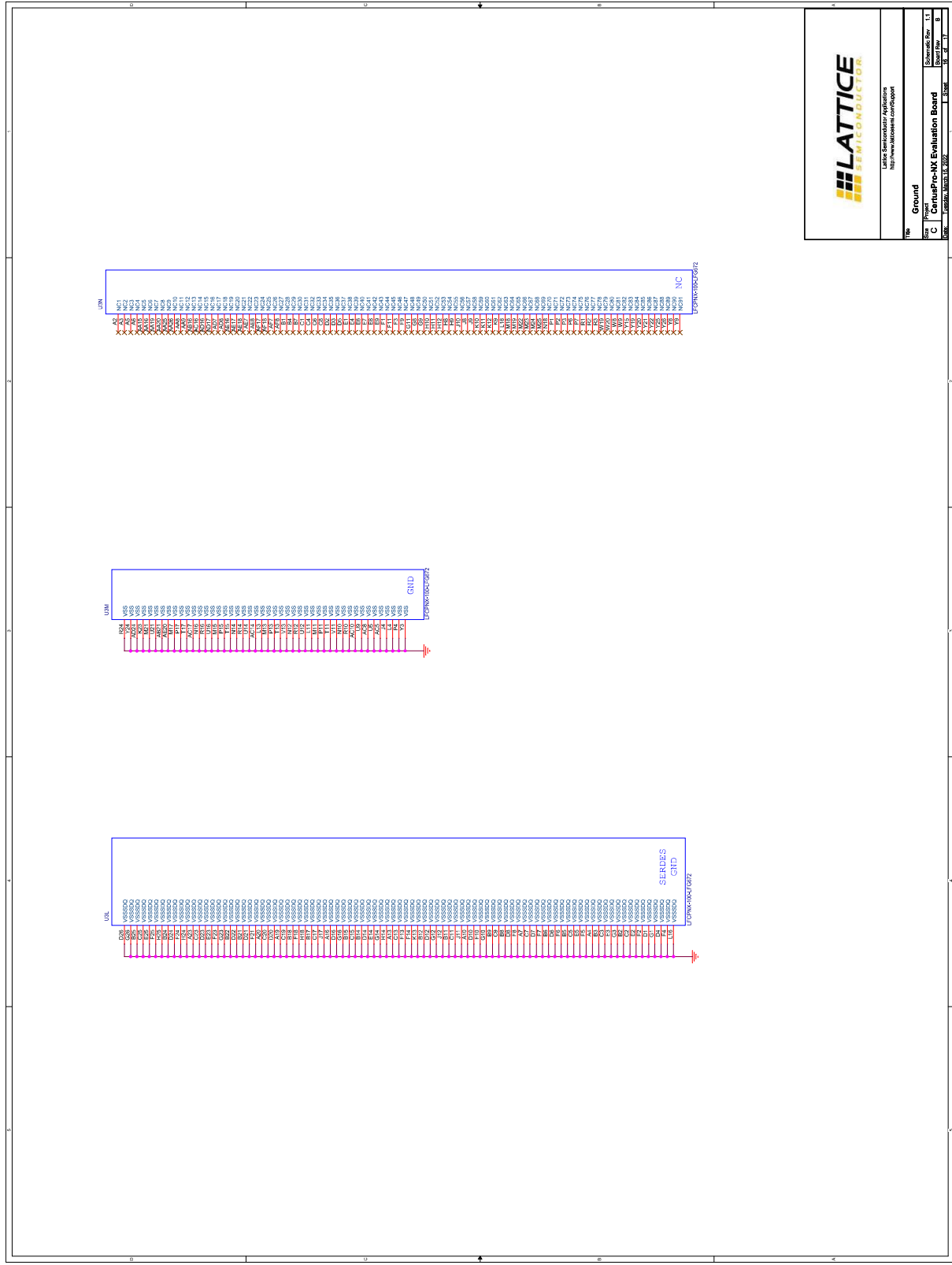

Figure A.16. Ground

© 2021-2022 Lattice Semiconductor Corp. All Lattice trademarks, registered trademarks, patents, and disclaimers are as listed at www.latticesemi.com/legal. All other brand or product names are trademarks or registered trademarks of their respective holders. The specifications and information herein are subject to change without notice.

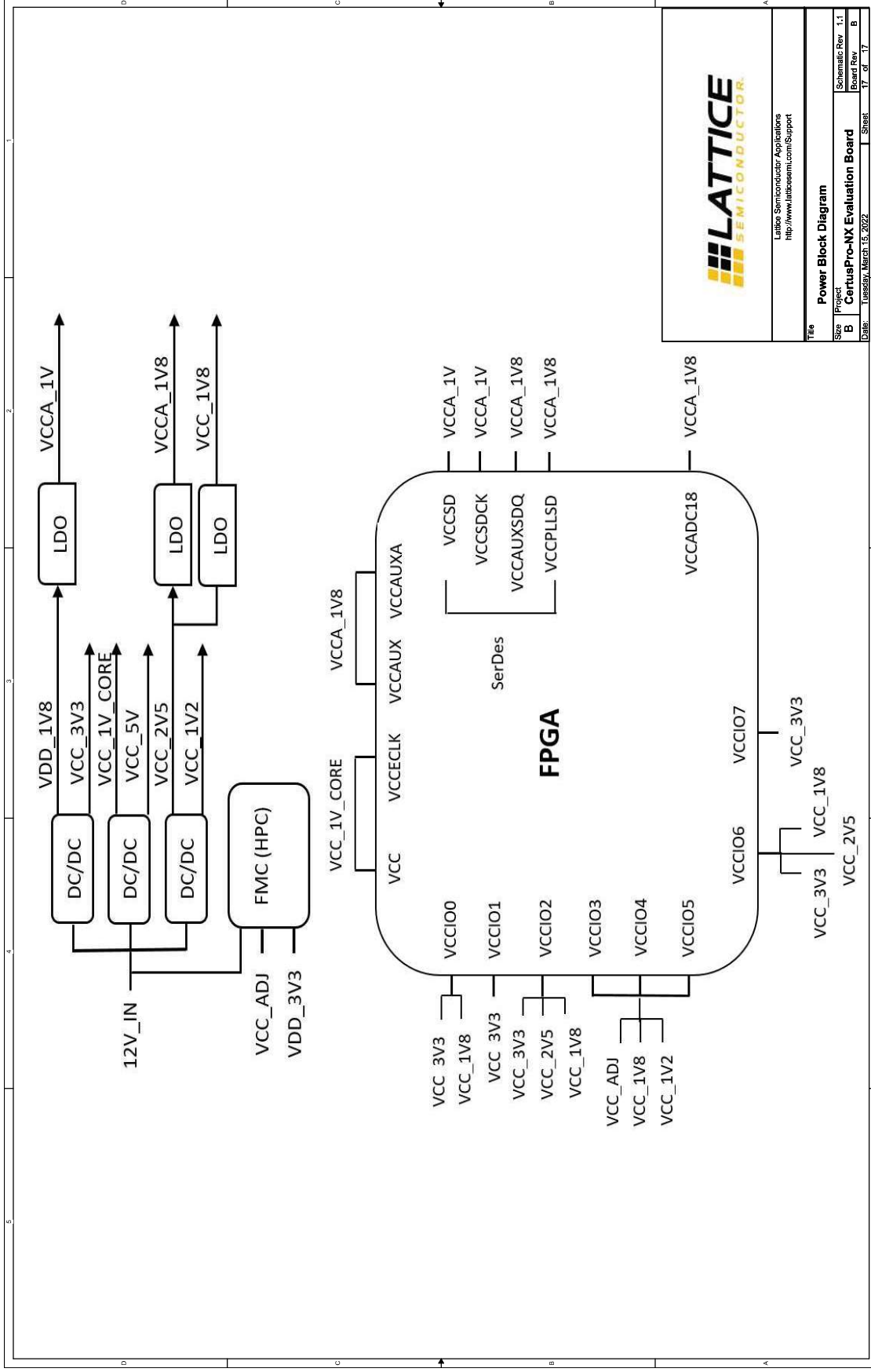

Figure A.17. Power Block Diagram

Appendix B. CertusPro-NX Evaluation Board Bill of Materials

Item	Reference	Qty	Part	PCB Footprint	Comments	Part Number	Manufacturer	Description
1	C1,C2,C3,C4,C7,C8,C10,C11,C12,C13,C15,C16,C20,C21,C22,C23,C26,C27,C29,C30,C31,C32,C34,C35,C36,C38,C39,C40,C42,C43,C44,C46,C48,C56,C57,C58,C59,C61,C63,C65,C66,C67,C68,C71,C72,C73,C74,C75,C76,C77,C78,C79,C80,C81,C82,C83,C84,C85,C86,C88,C122,C123,C125,C142,C143,C144,C145,C146,C147,C148,C149,C150,C151,C152,C153,C154,C155,C156,C157,C158,C159,C160,C161,C162,C164,C165,C166,C167,C171,C172,C173,C174,C175,C176,C177,C178,C179,C180,C182,C183,C184,C185,C186,C192,C196,C198,C248,C261,C266	109	0.1uF	C0201	—	GRM033R61E104KE14J	Murata	CAP CER 0.1UF 25V 10% X5R 0201
2	C5,C6,C9	3	4.7uF	C0603	—	CL10A475KA8NQNC	Samsung	CAP CER 4.7UF 25V X5R 0603
3	C14,C19,C28,C33,C37,C41,C55,C62,C64,C70,C87,C124,C138,C139,C140,C163,C168,C169,C181,C188,C190,C191,C193,C199,C201	25	10uF	C0402	—	CL05A106MP8NUB8	Samsung	CAP CER 10UF 10V X5R 0402
4	C17,C18	2	18pF	C0402	—	CL05C180J1B5NNNC	Samsung	CAP CER 18PF 50V C0G/NPO 0402
5	C24	1	0.01uF	C0402	DNI	CL05B103KA5NNNC	Samsung	CAP CER 10000PF 16V 5% X7R 0402
6	C25,C53,C60,C69,C121,C249,C253,C267,C270	9	1uF	C0603	—	TMK107B7105KA-T	Taiyo Yuden	CAP CER 1UF 25V 10% X7R 0603
7	C45,C47,C194,C215,C229,C230,C231,C232	8	10uF	C1206	—	TMK316B1106KL-T	Taiyo Yuden	CAP CER 10UF 25V X5R 1206
8	C49,C50,C51,C210,C211,C212,C213,C214,C225,C227,C228,C243,C244,C245,C246,C247,C262,C263,C264,C265,C269	21	22uF	C0603	—	GRM188R61A226ME15D	Murata	CAP CER 22UF 10V X5R 0603
9	C52,C254	2	0.1nF	C0603	—	CC0603JRNPO9BN101	Yageo	CAP CER 100PF 50V C0G/NPO 0603
10	C54,C250	2	3.3nF	C0201	—	GRM033R71E332KA12D	Murata	CAP CER 3300PF 25V X7R 0201
11	C89,C91,C93,C95,C97,C99,C101,C103,C105,C107,C109,C111,C113,C115,C117,C119	16	470NF	C0402	—	CGA2B3X7S1A474K050B E	TDK Corporation	CAP CER 0.47UF 10V X7S 0402
12	C90,C92,C94,C96,C98,C100,C102,C104,C106,C108,C110,C112,C114,C116,C118,C120	16	47UF	C0603	—	GRM188R60J476ME15D	Murata	CAP CER 47UF 6.3V X5R 0603

Item	Reference	Qty	Part	PCB Footprint	Comments	Part Number	Manufacturer	Description
13	C126,C128	2	1600pF	C0805	—	C0805C162J5GAC7800	Kemet	CAP CER 1600PF 50V NPO 0805
14	C127,C129	2	1600pF	C0805	DNI	C0805C162J5GAC7800	Kemet	CAP CER 1600PF 50V NPO 0805
15	C130,C131,C132,C133,C134,C135,C136,C137,C141,C170,C187,C189,C200	13	2.2uF	RLP-133	—	CL21B225KOFNNE	Samsung	CAP CER 2.2UF 16V X7R 0805
16	C195,C197,C216,C217,C233,C234	6	220NF	RLP-130-A	—	CL05A224K05NNNC	Samsung	CAP CER 0.22UF 16V X5R 0402
17	C202,C203,C218,C219,C235,C236	6	1000pF	RLP-130-A	—	CL05B102KB5NFNC	Samsung	CAP CER 1000PF 50V X7R 0402
18	C204,C207,C208,C224,C226,C239,C241,C242	8	10pF	RLP-130-A	—	CL05C100CB5NNNC	Samsung	CAP CER 10PF 50V C0G/NPO 0402
19	C205,C209,C220,C221,C237,C238	6	330pF	RLP-130-A	—	CL05B331KB5NNNC	Samsung	CAP CER 330PF 50V X7R 0402
20	C206,C222,C223,C240	4	10pF	RLP-130-A	DNI	CL05C100CB5NNNC	Samsung	CAP CER 10PF 50V C0G/NPO 0402
21	C251	1	6.8nF	C0603	—	CGA3E2C0G1H682J	TDK Corporation	CAP CER 6800PF 50V C0G 0603
22	C252	1	47pF	C0603	—	CGA3E2C0G1H470J	TDK Corporation	CAP CER 47PF 50V C0G 0603
23	C255	1	0.22uF	C0603	—	GCM188R71E224KA55D	Murata	CAP CER 0.22UF 25V X7R 0603
24	C256	1	0.1nF	C0603	DNI	CC0603JRNPO9BN101	Yageo	CAP CER 100PF 50V C0G/NPO 0603
25	C257,C258,C259,C260,C268	5	22uF	C0805	—	GRT21BR61E226ME13L	Murata	CAP CER 22UF 25V X5R 0805
26	C271,C272,C273,C274,C275,C276,C277,C278,C279,C280,C281,C282,C283,C284,C285,C286	16	0.1uF	C0402	—	CL05B104KA5NNNC	Samsung	CAP CER 0.1UF 25V 10% X7R 0402
27	INIT,DONE	2	TestPoint	TP50	—	—	—	—
28	D1,D5,D6,D7,D8,D9,D10,D11,D12,D13,D37,D38,D39,D42,D43,D44,D45,D50,D51	19	GREEN	APT1608	—	150060GS75000	Würth	LED GREEN CLEAR 0603 SMD
29	D3	1	ESDR0502N	UDFN6_040	—	ESDR0502NMUTBG	ON semi	TVS DIODE 5.5VWM UDFN6
30	D4,D22,D23,D24,D25,D26,D27,D28,D29	9	RED	APT1608	—	150060RS75000	Würth	LED RED CLEAR 0603 SMD
31	D14,D15,D16,D17,D18,D19,D20,D21	8	YELLOW	APT1608	—	150060YS75000	Würth	LED YELLOW CLEAR 0603 SMD

Item	Reference	Qty	Part	PCB Footprint	Comments	Part Number	Manufacturer	Description
32	D30	1	SCHOTTKY/ VISHAY- V12P10	V12P10	—	V12P10-M3/86A	Vishay	DIODE SCHOTTKY 100V 12A TO277A
33	D31,D32,D35,D36,D46,D47	6	1N4448W	1N4448W	—	1N4448WS	On Semi	DIODE GEN PURP 75V 150MA SOD323F
34	D33,D34,D40,D41,D48,D49	6	DFLS220L	DFLS220L	—	DFLS220L-7	Diodes	DIODE SCHOTTKY 20V 2A POWERDI123
35	FB1,FB2,FB3,FB5,FB6,FB13,FB15,FB16,FB17,FB18,FB19,FB20	12	MPZ1005S 121CT000	FB0402	—	MPZ1005S121CT000	TDK Corporation	FERRITE BEAD 120 OHM 0402 1LN
36	FB4,FB7,FB14	3	MPZ1005S 300CT000	FB0402	—	MPZ1005S300CT000	TDK Corporation	FERRITE BEAD 30 OHM 0402 1LN
37	L2,FB8,FB9,FB10,FB11,FB12	6	BLM15EG2 21SN1D	FB0402	—	BLM15EG221SN1D	Murata	PCle FERRITE BEAD 220 OHM 0402 1LN
38	F1	1	F1251CT- ND	154010	—	0154010.DR	Littelfuse	FUSE BRD MNT 10A 125VAC/VDC SMD
39	GND1,GND2,GND3,GND4,GND5	5	TestPoint_ Hole	TP	—	—	—	—
40	JP1,,JP2,JP3,JP4,JP5,JP6,JP7,JP11,,JP15,,JP16,,JP17 ,JP18	12	JUMPER	Header_1 x2	—	Regular 100Mil Header	—	—
41	JP12,,JP13	2	JUMPER	Header_1 x2	DNI	Regular 100Mil Header	—	—
42	JP14	1	Receptacle 20X2	HDR254- 2X20_soc ket	DNI	Regular 100Mil Header	—	—
43	J1	1	Header 1x8	hdr_amp_ 87220_8_ 1x8_100	DNI	Regular 100Mil Header	—	—
44	J2	1	USB_MINI_ B	USB_MINI _B- 1734035- 2	—	1734035-2	TE Connectivity AMP Connectors	CONN RCPT USB2.0 MINI B SMD R/A
45	J3,J10	2	Header_2x 7	Header_2 x7	DNI	Regular 100Mil Header	—	—
46	J4,J5,J6	3	PMOD 2x6	PPPC062L JBN-RC	—	PPPC062LJBN-RC	Sullins	CONN HDR 12POS 0.1 GOLD PCB R/A

Item	Reference	Qty	Part	PCB Footprint	Comments	Part Number	Manufacturer	Description
47	J11,J12,J13,J14,J15,J16,J19,J23,J24,J25,J26,J27,J28,J29,J30,J34,J35,J36,J37,J38,J39,J41,J42,J43,J44,J45,J46,J47	28	Header_2x1	Header_2x1	—	Regular 100Mil Header	—	—
48	J17,J18,J20,J21	4	CON3	CON3	—	Regular 100Mil Header	—	—
49	J22	1	Header_2x10	Header_2x10	—	Regular 100Mil Header	—	—
50	J31,J32,J33	3	GND	TUR_TH	—	—	—	—
51	J40	1	PJ-002A	pi_002a_3p	—	694106301002	Würth	CONN PWR JACK 2.1X5.5MM SOLDER
52	J48	1	ASP-134486-01	ASP-134486-01	—	ASP-134486-01	Samtec Inc.	CONN ARRAY RCPT 400POS SMD GOLD
53	L1	1	2.2uH SPM6530T-2R2M	SPM6530 T-2R2M	—	SPM6530T-2R2M	TDK Corporation	FIXED IND 2.2UH 8.2A 19 MOHM SMD
54	L3,L4,L5,L6,L7,L8	6	4.7uH SPD62R-472M	SPD62R	—	SPD62R-472M	API Delevan Inc.	FIXED IND 4.7UH 2A 150 MOHM SMD
55	L9	1	2.2uH SPM6550T-2R2M	SPM6550 T-2R2M	—	SPM6550T-2R2M	TDK Corporation	FIXED IND 2.2UH 13.4A 10.7 MOHM
56	PB1,PB2,PB3,M4,125MHZ,RESV_CLOCK,PROGR AMIN	7	TestPoint_SMT	TPC32	—	—	—	—
57	Q1,Q2,Q3,Q4,Q5,Q6	6	MMBT2222 ALT1G	MMBT2222 2ALT-1	—	MMBT2222ALT1G	ON Semiconductor	TRANS NPN 40V 0.6A SOT23
58	R1,R5,R11,R19,R24,R25,R92,R125	8	2.2k	R0603	—	RC0603FR-072K2L	Yageo	RES SMD 2.2K OHM 1% 1/10W 0603
59	R2,R3,R4,R21,R27,R30,R31,R32,R33,R34,R35,R36,R37,R38,R39,R41,R47,R48,R85,R86,R87,R90,R91,R156,R157,R168	26	4.7K	R0603	—	RC0603FR-074K7L	Yageo	RES SMD 4.7K OHM 1% 1/10W 0603
60	R6,R55,R110,R254	4	22	R0402	—	ERJ-2RKF22R0X	Panasonic	RES SMD 22 OHM 1% 1/10W 0402
61	R7,R8,R9,R20,R42,R43,R44,R45,R46,R53,R54,R158,R159,R165,R218,R219,R220,R221,R227,R228,R232,R233	22	0	R0402	—	RC0402FR-070RL	Yageo	RES SMD 0 OHM JUMPER 1/16W 0402

Item	Reference	Qty	Part	PCB Footprint	Comments	Part Number	Manufacturer	Description
62	R10,R105,R107,R108,R260,R261,R263,R264,R265,R266	10	0	R0402	DNI	RC0402FR-070RL	Yageo	RES SMD 0 OHM JUMPER 1/16W 0402
63	R12,R13,R14,R16,R17,R22,R26,R28,R83,R84,R102,R109,R185,R187,R199,R209,R210,R211,R217,R236,R237,R241,R255,R256	24	10K	R0603	—	RC0603FR-0710KL	Yageo	RES SMD 10K OHM 1% 1/10W 0603
64	R15,R240	2	12K	R0603	—	RC0603FR-0712KL	Yageo	RES SMD 12K OHM 1% 1/10W 0603
65	R23,R29,R50,R51	4	100	R0402	—	RC0402FR-07100RL	Yageo	RES SMD 100 OHM 1% 1/16W 0402
66	R40	1	1K	R0603	DNI	RC0603FR-071KL	Yageo	RES SMD 1K OHM 1% 1/10W 0603
67	R49,R238,R257	3	10K	R0603	DNI	RC0603FR-0710KL	Yageo	RES SMD 10K OHM 1% 1/10W 0603
68	R52,R56,R57,R58,R59,R60,R61,R62,R63,R64,R65,R66,R67,R68,R69,R70,R71,R72,R73,R74,R75,R76,R77,R78,R79,R95,R96,R196,R245,R251,R252	31	1k	R0603	—	RC0603FR-071KL	Yageo	RES SMD 1K OHM 1% 1/10W 0603
69	R80,R81,R82,R133,R134,R145,R259,R262	8	0	R0603	—	RC0603FR-070RL	Yageo	RES SMD 0 OHM JUMPER 1% 1/10W 0603
70	R100	1	300	R0402	—	ERJ-2RKF3000X	Panasonic	RES SMD 300 OHM 1% 1/10W 0402
71	R103,R104,R132,R135,R136,R138,R141,R144,R146,R148,R150,R173,R215,R216,R247,R248,R258	17	0	R0603	DNI	RC0603FR-070RL	Yageo	RES SMD 0 OHM JUMPER 1% 1/10W 0603
72	R106	1	22	R0402	DNI	ERJ-2RKF22R0X	Panasonic	RES SMD 22 OHM 1% 1/10W 0402
73	R111,R112,R113,R114,R115,R116,R126,R137,R139,R140,R142,R143,R147,R149,R151,R152,R153,R154,R155,R160,R161,R167,R169,R170,R183,R184,R200,R201	28	0.1	603	—	ERJ-3RSFR10V	Panasonic	RES 0.1 OHM 1% 1/10W 0603
74	R117,R118,R119,R120,R121,R122,R123,R124	8	1.15K	R0402	—	RT0402BRD071K15L	Yageo	RES SMD 1.15KOHM 0.1% 1/16W 0402
75	R127	1	1K	R0805	—	ERJ-6ENF1001V	Panasonic	RES SMD 1K OHM 1% 1/8W 0805
76	R128,R129,R130,R131	4	100	R0805	—	ERJ-6ENF1000V	Panasonic	RES SMD 100 OHM 1% 1/8W 0805

Item	Reference	Qty	Part	PCB Footprint	Comments	Part Number	Manufacturer	Description
77	R162	1	6.49K	R0603	DNI	RC0603FR-076K49L	Yageo	RES SMD 6.49K OHM 1% 1/10W 0603
78	R163,R166	2	23.7K	R0603	DNI	RC0603FR-0723K7L	Yageo	RES SMD 23.7K OHM 1% 1/10W 0603
79	R164,R177,R179,R198,R206	5	51K	R0402	—	RC0402FR-0751KL	Yageo	RES SMD 51K OHM 1% 1/16W 0402
80	R171	1	1.15K	R0603	—	RC0603FR-071K15L	Yageo	RES SMD 1.15K OHM 1% 1/10W 0603
81	R172	1	35.7K	R0603	—	RC0603FR-0735K7L	Yageo	RES SMD 35.7K OHM 1% 1/10W 0603
82	R174	1	909	R0603	—	RC0603FR-07909RL	Yageo	RES SMD 909 OHM 1% 1/10W 0603
83	R175,R191,R208	3	20K	R0402	—	ERJ-2RKF2002X	Panasonic	RES SMD 20K OHM 1% 1/10W 0402
84	R176,R207	2	34K	R0402	—	RC0402FR-0734KL	Yageo	RES SMD 34K OHM 1% 1/16W 0402
85	R178	1	11.5K	R0603	—	RC0603FR-0711K5L	Yageo	RES SMD 11.5K OHM 1% 1/10W 0603
86	R180,R182,R194,R197,R202,R203	6	2.2K	R1206	—	RC1206FR-072K2L	Yageo	RES SMD 2.2K OHM 1% 1/4W 1206
87	R181	1	10K	R1206	—	RC1206JR-0710KL	Yageo	RES SMD 10K OHM 5% 1/4W 1206
88	R186	1	200	R0603	—	RC0603FR-07200RL	Yageo	RES SMD 200 OHM 1% 1/10W 0603
89	R188	1	51K	R0603	—	RC0603FR-0751KL	Yageo	RES SMD 51K OHM 1% 1/10W 0603
90	R189,R212	2	30.1K	R0402	—	ERJ-2RKF3012X	Panasonic	RES SMD 30.1K OHM 1% 1/10W 0402
91	R190	1	63.4K	R0402	—	ERJ-2RKF6342X	Panasonic	RES SMD 63.4K OHM 1% 1/10W 0402
92	R192,R195	2	768	R0603	—	RC0603FR-07768RL	Yageo	RES SMD 768 OHM 1% 1/10W 0603
93	R193	1	9.76K	R0603	—	RC0603FR-079K76L	Yageo	RES SMD 9.76K OHM 1% 1/10W 0603
94	R204	1	21.5K	R0603	—	RC0603FR-0721K5L	Yageo	RES SMD 21.5K OHM 1% 1/10W 0603

Item	Reference	Qty	Part	PCB Footprint	Comments	Part Number	Manufacturer	Description
95	R205	1	15K	R0603	—	RC0603FR-0715KL	Yageo	RES SMD 15K OHM 1% 1/10W 0603
96	R213,R214,R226,R231	4	100	R0402	DNI	RC0402FR-07100RL	Yageo	RES SMD 100 OHM 1% 1/16W 0402
97	R222,R223,R224,R225,R229,R230,R234,R235	8	50	R0402	DNI	RC0402JR-0750RL	Yageo	RES SMD 50 OHM 5% 1/16W 0402
98	R239	1	68K	R0603	—	RC0603FR-0768KL	Yageo	RES SMD 68K OHM 1% 1/10W 0603
99	R242	1	91K	R0603	—	RC0603FR-0791KL	Yageo	RES SMD 91K OHM 1% 1/10W 0603
100	R243	1	49.9K	R0603	—	CRCW060349K9FKTA	Vishay	RES SMD 49.9K OHM 1% 1/10W 0603
101	R246	1	4m OHM	R1206	—	CSR1206-0R004F1	Riedon	RES 0.004 OHM 1% 1W 1206
102	R249,R250	2	4.7k	R0603	DNI	RC0603FR-074K7L	Yageo	RES SMD 4.7K OHM 1% 1/10W 0603
103	SMA1,SMA2	2	SMA_SDQ0_REFCLK_P/N	CONN_SMA-J-P-H-ST-TH1	—	SMA-J-P-H-ST-TH1	Samtec Inc.	CONN SMA JACK STR 50 OHM PCB
104	SW1,SW2,SW4,SW5	4	430182043 816	43018204 3816	—	PTS645SM43SMTR92 LFS	C&K Components	SWITCH TACTILE SPST-NO 0.05A 12V
105	SW3	1	TDA DIP-8	TDA08H05 B1	—	TDA08H0SB1	C&K Components	SWITCH SLIDE DIP SPST 25MA 24V
106	U1	1	FT2232HL	tfp64_0p 5_12p2x1 2p2_h1p6	—	FT2232HL-REEL	FTDI	IC USB HS DUAL UART/FIFO 64-LQFP
107	U2	1	93LC56C-I/SN	so8_50_2 44	—	93LC56C-I/SN	Microchip Technology	IC EEPROM 2KBIT 3MHZ 8SOIC
108	U3	1	LFCPNX-100-LFG672	BGA672-1P0	—	LFCPNX-100-9LFG672C	Lattice	CertusPro-NX FPGA Package LFG672-9
109	U4	1	MT25QU12 8ABA1ESE-OSIT	SO8_MX2 5L12833F M2110G	—	MT25QU128ABA1ESE-OSIT	Micron	IC FLASH 128MBIT 133MHZ 16SOP
110	U6	1	BD9D321EF J	HTSOP_8_BD9D321	—	BD9D321EFJ-E2	Rohm Semiconductor	IC REG BUCK ADJ 3A 8HTSOP-J

Item	Reference	Qty	Part	PCB Footprint	Comments	Part Number	Manufacturer	Description
111	U7	1	MAX6070B AUT18+T	SOT23- 6_MAX60 70	—	MAX6070BAUT18+T	Maxim Integrated	IC VREF SERIES 1.8V SOT23-6
112	U8	1	PTD901- 1015K- B103	PTD901_1 015K_B10 3	—	PTD901-1015K-B103	Bourns Inc.	POT 10K OHM 1/20W CARBON LINEAR
113	U9	1	RP115H101 D/SOT89-5	SOT89-5	—	RP115H101D-T1-FE	Ricoh	IC REG LDO FIXED 1.0V 1A OUTPUT SOT89-5
114	U10,U11	2	RP115H181 D/SOT89-5	SOT89-5	—	RP115H181D-T1-FE	Ricoh	IC REG LDO FIXED 1.8V 1A OUTPUT SOT89-5
115	U12,U13,U14	3	LT3508EUF	LT3508EUF	—	LT3508EUF#PBF	Linear Technology/An alog Devices	IC REG BUCK ADJ 1.4A DL 24QFN
116	U26	1	R1273L031 A	QFN0505 _32B	—	R1273L031A	Ricoh	34V 1CH 14A Synchronous Step- down DC/DC Converter
117	U27	1	HCSL_CLOCK _161MHZ	NX32X25	DNI	—	—	—
118	VCCIO1,VCCIO2,VCCIO3,VCCIO4,VCCIO5,VCCIO6,VCCIO7,V1P0_VCCSDCK,V1P0_VCCSD,VDD_3V3,V1P8_VCCPLSD0,V1P8_VCCAUXSDQ0,V1P8_VCCPLSD1,V1P8_VCCAUXSDQ1,VREFB,VREFA,VCC_CORE,VCC_ADJ,VCCIO0,VCCECLK,VCCAUX,VCCAUX	22	TP_S_40_6 3	tp_s_40_6 3	—	—	—	—
119	X1	1	7M- 12.000MAA J	xtal_4p_7 m	—	7M-12.000MAAJ-T	TXC	CRYSTAL 12MHZ 18PF SMD
120	X2	1	HCSL_CLOCK _100MHZ	DSC1123C I5	DNI	—	—	—
121	X3	1	LVCMOS_C LOCK	x4-2520	—	ASDMB-125.000MHZ-XY- T	Abracon LLC	OSC MEMS 125.000MHZ CMOS SMD 10ppm
122	X4	1	LVCMOS_C LOCK	x4-2520	DNI	ASDMB-100.000MHZ-XY- T	Abracon LLC	OSC MEMS 100.000MHZ CMOS SMD 10ppm

Item	Reference	Qty	Part	PCB Footprint	Comments	Part Number	Manufacturer	Description
123	27G_SMA1,27G_SMA2,27G_SMA5,27G_SMA6,27G_SMA9,27G_SMA10,27G_SMA13,27G_SMA14	8	27G_SMA	SV_SF292 1-61356-2S	DNI	SF2921-61356-2S	Amphenol SV Microwave	CONN SMA JACK STR 50 OHM SMD INNER
124	27G_SMA3,27G_SMA4,27G_SMA7,27G_SMA8,27G_SMA11,27G_SMA12,27G_SMA15,27G_SMA16	8	27G_SMA	SV_SF292 1-61345-2S	DNI	SF2921-61345-2S	Amphenol SV Microwave	CONN SMA JACK STR 50 OHM SMD TOP
125	TP_U1,TP_T1,TP_J1,TP_H1,TP_U2,TP_T2,TP_H2,TP_U3,TP_T3,TP_AE3_N,TP_AD3_P,5V,TP_U6,GND6,TP_U7,GND7,GND8,GND9,GND10,GND11,TP_Y12_P,TP_W12_N,GND12,1V2,GND13,GND14,GND15,GND16,GND17,TP_V18,TP_U18,TP_T18,TP_R18,GND18,1V8,TP_V19,TP_U19,TP_T19,TP_R19,GND19,TP_V20,TP_T20,TP_R20,TP_AC20_P,TP_AB20_N,GND20,TP_V21,TP_T21,TP_R21,TP_P21,GND21,TP_V22_N,TP_U22,TP_T22,TP_R22,TP_P22,GND22,TP_V23_P,TP_U23,TP_T23,TP_P23,GND23,TP_U24,TP_T24,TP_P24,GND24,TP_U25,TP_T25,TP_R25,TP_P25,GND25,2V5,TP_T26,TP_R26,TP_P26,GND26,3V3,ADJ	78	T POINT R	TP	—	—	—	—
126	CertusPro-NX Evaluation Board PCB REV6	1	—	—	—	—	PACTRON	—

References

Related documents available from your Lattice Semiconductor sales representative are listed below.

- [Programming Cables User Guide \(FPGA-UG-02042\)](#)
- [CertusPro-NX Family Data Sheet \(FPGA-DS-02086\)](#)
- [sysCONFIG User Guide for Nexus Platform \(FPGA-TN-02099\)](#)

Technical Support Assistance

Submit a technical support case through www.latticesemi.com/techsupport.

Revision History

Revision 1.1, April 2022

Section	Change Summary
CertusPro-NX Clock Sources	Updated Table 5.1. Clock Sources . Changed clock frequencies to Optional. Added information on SerDes support and clock resources.
Appendix A. CertusPro-NX Evaluation Board Schematics	Updated schematics.
Appendix B. CertusPro-NX Evaluation Board Bill of Materials	Changed references U27 and X2 values.

Revision 1.0, August 2021

Section	Change Summary
All	Production release.



www.latticesemi.com