

# SPECIFICATION 产品规格书



REFOND P/N 产品型号

RF-816

R&D 研发

Mass Product 量产供货

## Contents 目录

1.Features 产品特征 .....	3
2.Description 产品介绍 .....	3
3.Applications 产品应用 .....	3
4.Naming Rule 命名规则 .....	4
5.Package Dimension (Unit: mm) 封装尺寸 (单位: 毫米) .....	5
6.Plastic pipe Dimensions 料管尺寸 .....	7
7.Taping Dimensions 载带尺寸 .....	7
8.Packaging Specification 包装规格 .....	10
9.Absolute Maximum Ratings at Ta=25°C 在 25 摄氏度下的最大额定值 .....	11
10.Electro-Optical Characteristics (Ta=25°C unless specified otherwise 光电特性参数(在 25 摄氏度的条件下) ...	12
11.Rank Table of Current Transfer Ratio 电流传输比分级范围 .....	13
12.Temperature Profile Of Soldering 焊接温度程序 .....	13
13.Characteristics Curves 特性曲线 .....	16

REFOND

## 1.Features 产品特征

- (1) Current transfer ratio ( CTR : MIN. 200% at IF = 5mA, VCE = 5V)  
电流传输比 ( CTR : MIN. 200% at IF = 5mA, VCE = 5V)
- (2) High input-output isolation voltage ( Viso = 5,000V)  
高输入输出隔离电压 ( Viso = 5,000V)
- (3) Response time ( tr : TYP. 4 $\mu$ s at VCE = 2V, IC = 2mA, RL = 100 $\Omega$ )  
响应时间 ( tr : TYP. 4 $\mu$ s at VCE = 2V, IC = 2mA, RL = 100 $\Omega$ )

## 2.Description 产品介绍

- (1) RF-816 photocoupler consist of one piece of GaAs emitter and one piece of NPN transistor.  
RF-816 光电耦合器是由一个砷化镓材质的发射器和一个的NPN三极管组成。
- (2) They are packaged in a 4-pin DIP package and available in wide-lead spacing and SMD option.  
它是一个 4 针脚的封装形式，具有 DIP 脚型和 SMD 脚型的选项。

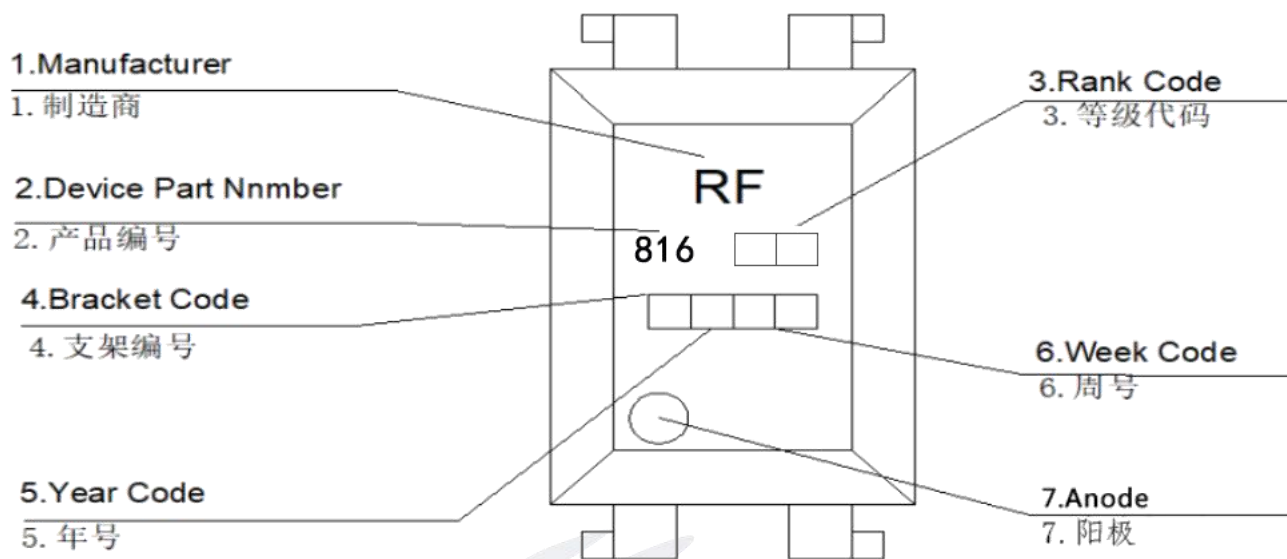


## 3.Applications 产品应用

- (1) Computer terminals. 计算机终端。
- (2) System appliances, measuring instruments. 电器系统，测量仪器。
- (3) Registers, copiers, automatic vending machines. 记录仪，复印机，自动售货机。
- (4) Electric home appliances, such as fan heaters, etc. 家居电器，如电风扇，加热器等。
- (5) Signal transmission between circuits of different potentials and impedances.  
在不同电位和阻抗的电路之间的信号传输。

REFOND

## 4.Naming Rule 命名规则



- (1) RF denotes REFOND. 瑞丰代号
- (2) denotes Device Part Number. 产品编号
- (3)  denotes Rank code. 产品等级代号
- (4)  denotes Bracket Code. 支架代号
- (5)  denotes Year Code. 年号
- (6)  denotes Week code. 周号
- (7) Anode. 阳极
- (8) The naming rules of product names are as follows. 产品品名命名规则如下:

### RF-816(1)(2)-(3)-(4)

Note 注释:

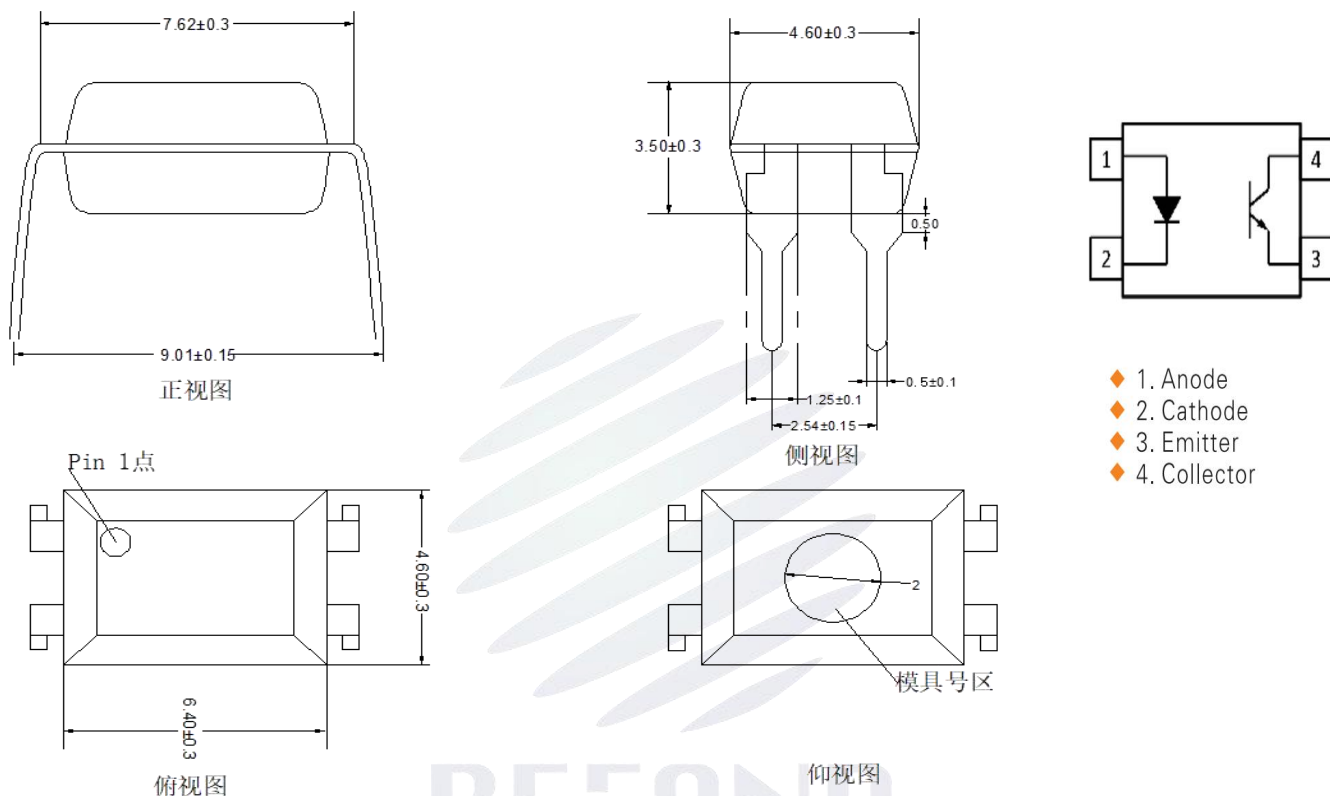
- (1) No suffix = Dual-in-Line package 无后缀 = 双列直插封装  
 M = Wide lead spacing package M = 宽式双列直插  
 S = Surface mounting package S = 贴片封装
- (2) CTR RANK (C,D,D1,D2 or none) CTR 档位 (C,D,D1,D2 or none)  
 Please refer to the CTR table on Page P13, Rank Table of Current Transfer Ratio  
 请参考 P13 页的 CTR 表, 电流传输比分级范围.
- (3) TAPING TYPE (TA, TA1, TP or none) 编带类型 (TA, TA1, TP or none)  
 Please refer to orientation of taping on Page P7-P9 请参考 P7-P9 页的编带方向
- (4) Pin Material Option (F=Iron; C=Copper) Pin 脚材质 (F=铁; C=铜)

Note: 1. All products of this specification are halogen-free and can be added to the product name. 备注: 1. 此规格所有产品都是无卤素, 品名中可选加入。

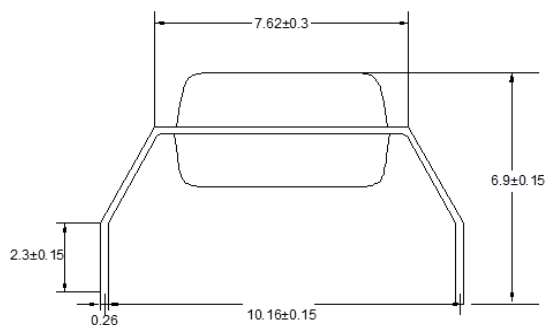
2. All products of this specification have passed CQC VDE UL certification, and can be added to the product name. 此规格产品都有通过 CQC VDE UL 认证, 品名中可选加入。

## 5.Package Dimension (Unit: mm) 封装尺寸 (单位: 毫米)

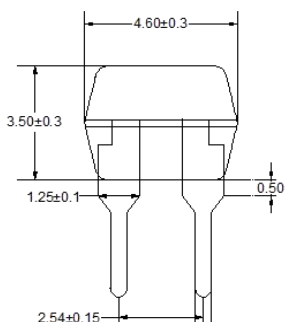
### (1) RF-816



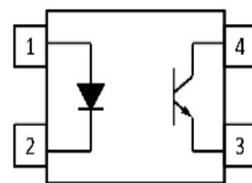
### (2) RF-816M



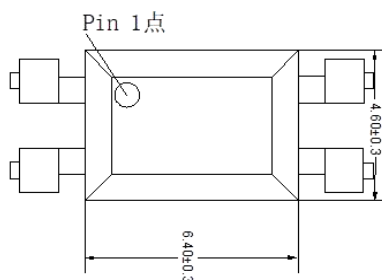
正视图



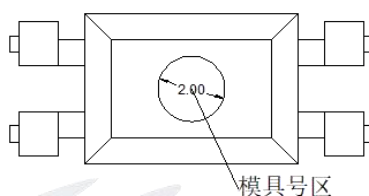
侧视图



- ◆ 1. Anode
- ◆ 2. Cathode
- ◆ 3. Emitter
- ◆ 4. Collector

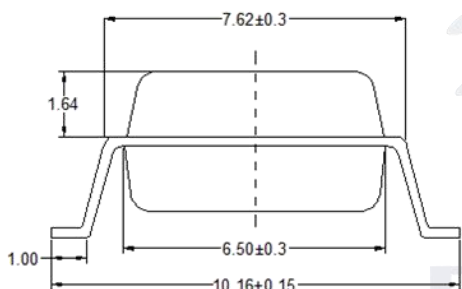


俯视图

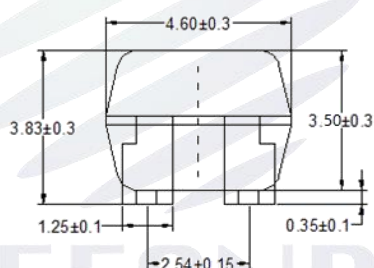


仰视图

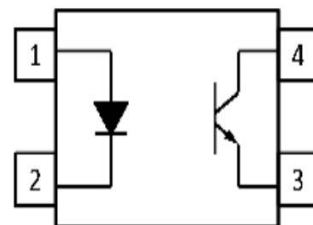
### (3) RF-816S



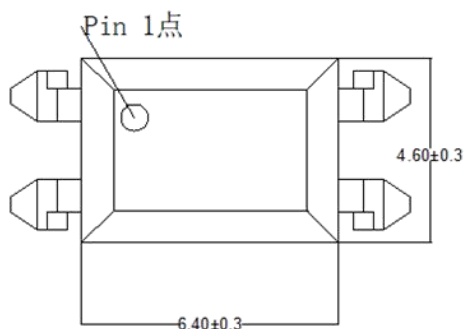
正视图



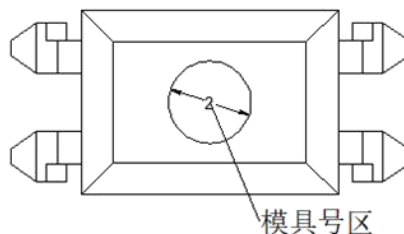
侧视图



- ◆ 1. Anode
- ◆ 2. Cathode
- ◆ 3. Emitter
- ◆ 4. Collector

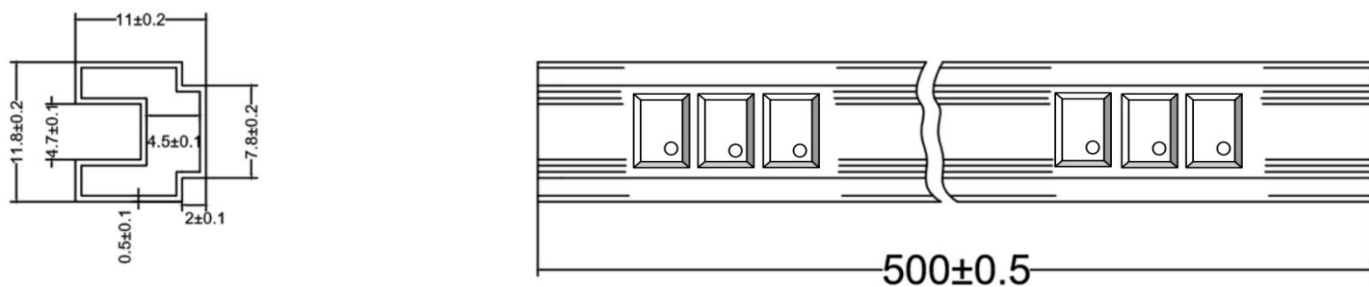


俯视图



仰视图

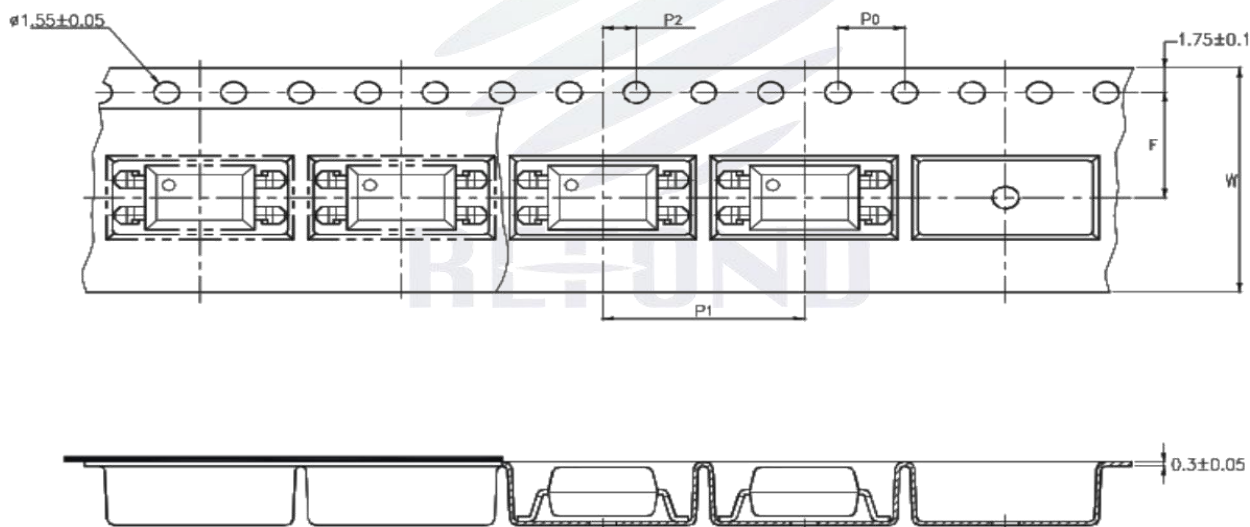
## 6. Plastic pipe Dimensions 料管尺寸



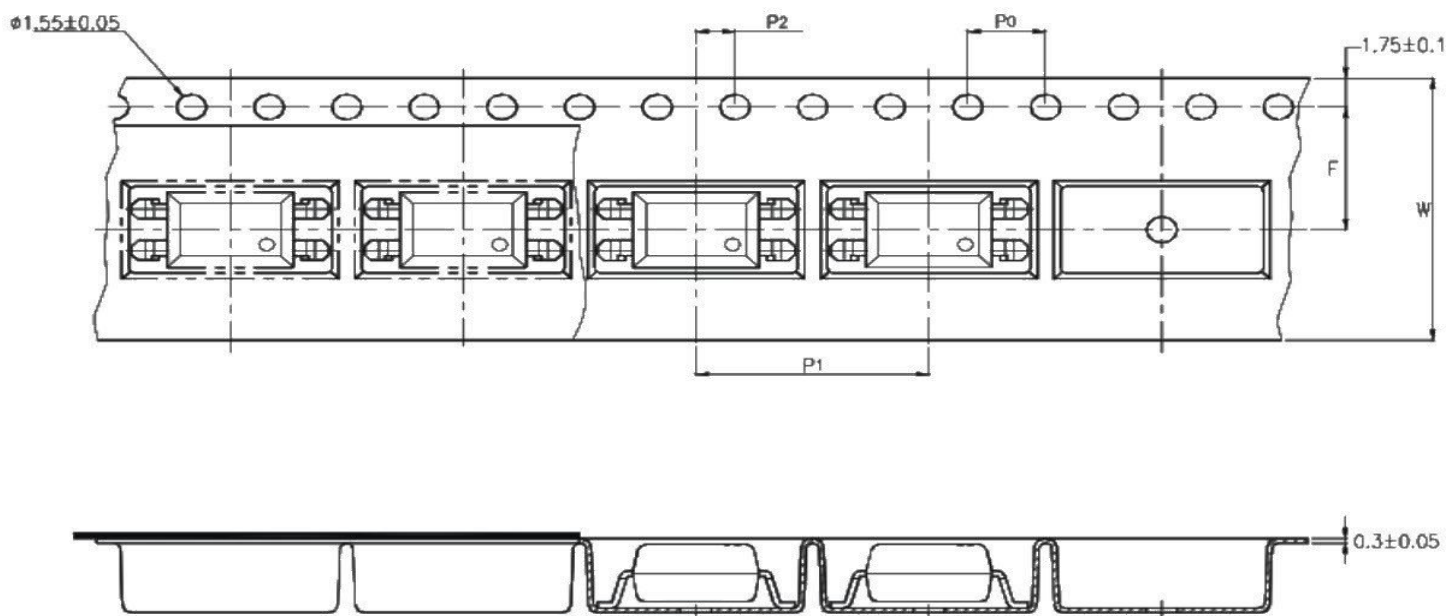
Package Type 封装类型	DP
Quantities(pcs) 数量	100

## 7. Taping Dimensions 载带尺寸

### (1) RF-816S-TA



### (2) RF-816S-TA1

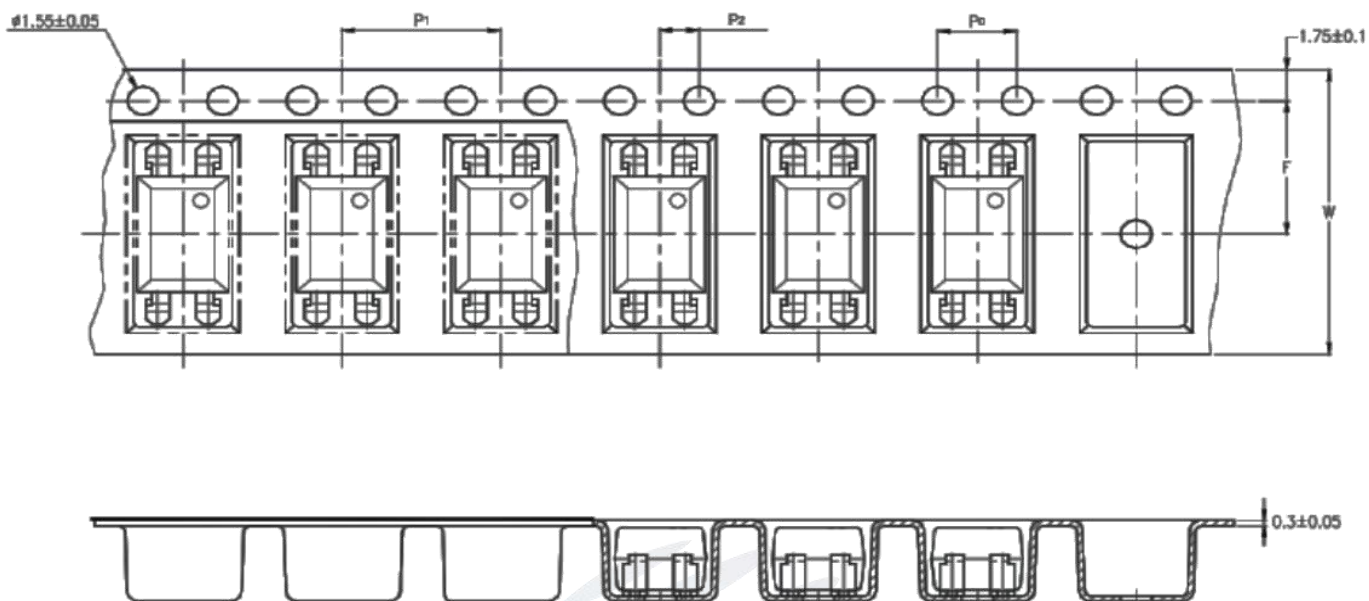


Description 描述	Symbol 符号	Dimension in mm (inch) 尺寸毫米 (英寸)
Tape wide 载带宽度	W	16±0.3 (.63)
Pitch of sprocket holes 孔位间距	P <sub>0</sub>	4±0.1 (.15)
Distance of compartment 产品中心与孔位的距离	F	7.5±0.1 (.295)
	P <sub>2</sub>	2±0.1 (.0079)
Distance of compartment to compartment 元件间距	P <sub>1</sub>	12±0.1 (.472)

Package Type 封装类型	TA/TA1
Quantities(pcs) 数量	1000



### (3) RF-816S-TP

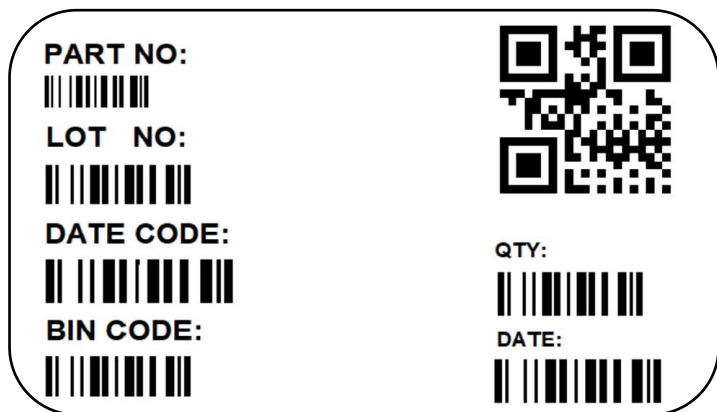


Description 描述	Symbol 符号	Dimension in mm (inch) 尺寸毫米 (英寸)
Tape wide 载带尺寸	W	16±0.3 (.63)
Pitch of sprocket holes 孔位间距	$P_0$	4±0.1 (.15)
Distance of compartment 产品中心与孔位的距离	F	7.5±0.1 (.295)
	$P_2$	2±0.1 (.0079)
Distance of compartment to compartment 元件间距	$P_1$	8±0.1 (.472)

Package Type 封装类型	TP
Quantities(pcs) 数量	2000

## 8. Packaging Specification 包装规格

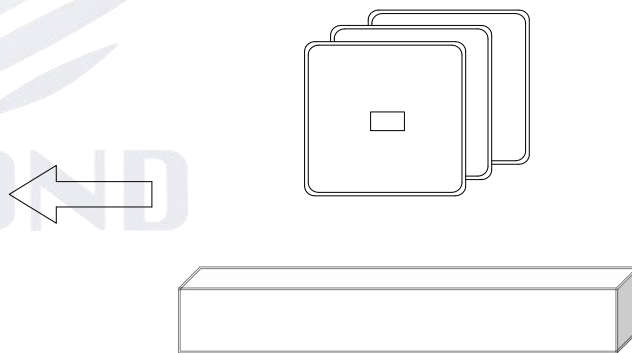
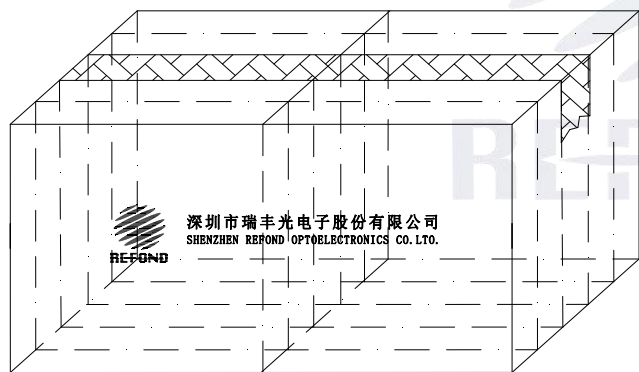
### (1) Label Form Specification 标签规格



### Label Form Specification 标签规格

PART NO	Part Number 品名
LOT NO	Lot Number 批次号
DATE CODE	date Code 周期编号
BIN CODE	Bin code 档位
QTY	Packing Quantity 数量
DATE	Made Date 生产日期

### (5) Cardboard Box 包装纸箱



Package Type 封装类型	DP	TP	TA/TA1
Quantities(pcs) 数量	50000	40000	20000

## 9. Absolute Maximum Ratings at Ta=25°C 在 25 摄氏度下的最大额定值

	Parameter 参数	Symbol 符号	Rated Value 额定值	Unit 单位
Input	Forward Current 输入电流	I <sub>F</sub>	60	mA 毫安
	Peak forward current (100μs pulse, 100Hz frequency) 尖峰输入电流	I <sub>FP</sub>	1	A 安培
	Reverse Voltage 反向电压	V <sub>R</sub>	6	V 伏特
	Consume Power 额定功率	P	70	mW 毫瓦
Output	Collector and emitter Voltage 三极管CE级电压	V <sub>CEO</sub>	80	V 伏特
	Emitter and collector Voltage 三极管EC级电压	V <sub>ECO</sub>	7	V 伏特
	Collector Current 输出电流	I <sub>C</sub>	50	mA 毫安
	Consume Power 额定功率	P <sub>C</sub>	150	mW 毫瓦
Total Consume Power 总功率		P <sub>tot</sub>	200	mW 毫瓦
*1 Insulation Voltage 绝缘电压		V <sub>iso</sub>	5,000	V 伏特
Max Insulation Voltage (Insulating oil test) 最大的绝缘电压 (绝缘油测试)		VIOTM	10,000	V 伏特
Rated Impulse Insulation Voltage 额定脉冲绝缘电压		VIORM	630	V 伏特
Working Temperature 工作温度		T <sub>opr</sub>	-55 to + 110	°C 摄氏度
Deposit Temperature 存储温度		T <sub>stg</sub>	-55 to + 125	
*2 Soldering Temperature 焊接温度		T <sub>sol</sub>	260	

\*1.AC For 1 Minute, R.H. = 40 ~ 60%.

Isolation voltage shall be measured using the following method.

隔离电压应该使用以下方法测量。

① Short between anode and cathode on the primary side and between collector and emitter on the secondary side.

第一让二极管的阳极和阴极短路，第二让三极管的集电极和发射极短路，

② The isolation voltage tester with zero-cross circuit shall be used.

孤立电压测试机应该使用零交叉电路。

③The waveform of applied voltage shall be a sine wave.

施加电压的波形应为正弦波。

\*2.Soldering time is 10seconds. 焊接时间为 10 秒

## 10.Electro-Optical Characteristics (Ta=25°C unless specified otherwise 光电特性参数 (在 25 摄氏度的条件下))

Parameter 参数		Symbol 符号	Condition 条件	Min 最小	Typ.* 类型	Max 最大	Unit 单位
Input 输入	Forward Voltage 输入电压	$V_F$	$I_F=20mA$	---	1.2	1.4	V 伏特
	Reverse Current 反向电流	$I_R$	$V_R=4V$	---	---	10	$\mu A$ 微安
	Collector capacitance 集电电容	$C_t$	$V=0, f=1KHz$	---	30	250	pF 皮法
Output 输出	Collector to emitter Current 三极管CE级电流	$I_{CEO}$	$V_{CE}=20V,$ $I_F=0mA$	---	---	100	nA 纳安
	Collector and Emitter attenuation Voltage 三极管CE级电压	$BV_{CEO}$	$I_C=0.1mA$ $I_F=0mA$	80	---	---	V 伏特
	Emitter and Collector attenuation Voltage 三极管EC级电压	$BV_{ECO}$	$I_E=0.01mA$ $I_F=0mA$	7	---	---	V 伏特
Transforming Characteristics 传输特性	*1 Current conversion ratio 电流传输比	CTR	$I_F=5mA$ $V_{CE}=5$ V	200	---	600	% 百分比
	Collector Current 输出电流	$I_C$		10	---	50	mA 毫安
	Collector and Emitter Saturation Voltage 饱和电压	$V_{CE(sat)}$	$I_F=20mA$ $I_C=1mA$	---	0.1	0.2	V 伏特
	Insulation Impedance 隔离电阻	$R_{iso}$	DC500V 40~60%R.H.	---	$1 \times 10^{12}$	---	$\Omega$ 欧姆
	Floating Capacitance 浮动电容	$C_f$	$V=0, f=1MHz$	---	0.6	1.0	pF 皮法

Cut-off Frequency 截止频率	$f_c$	$V_{CE}=5V$ $I_C=2mA$ $R_L=100\Omega, -3dB$	---	80	---	kHz 千赫兹
Rise Time 上升时间	$t_r$	$V_{CE}=2V$ $I_C=2mA$	---	4	12	$\mu s$ 微秒
Descend Time 下降时间	$t_f$	$R_L=100\Omega$	---	3	12	$\mu s$ 微秒

\*1 Current Conversion Ratio =  $I_C / I_F \times 100\%$  , CTR Tolerance:  $\pm 3\%$ .

电流传输比 =  $I_C / I_F \times 100\%$  , CTR 公差:  $\pm 3\%$ .

## 11. Rank Table of Current Transfer Ratio 电流传输比分级范围

Grade Sign 等级标志	Min (%) 最小	Max (%) 最大
RF-816C	200	400
RF-816D	300	600
RF-816D1	300	450
RF-816D2	450	600

Note:

1. Working condition:  $I_F=5mA$ ,  $V_{CE}=5V$ ,  $T_a=25^\circ C$ .

2. When customers applies the Photo coupler to the series and parallel circuit, should take consideration of all the factors such as the current, voltage distribution, heat dissipation and others.

注意:

1. 工作条件为  $I_F=5mA$ ,  $V_{CE}=5V$ ,  $T_a=25^\circ C$ 。

2. 客户端将光耦应用于串、并联线路时，需自行评估电流、电压分配、散热等问题。

## 12. Temperature Profile Of Soldering 焊接温度程序

### (1). IR Reflow soldering (JEDEC-STD-020C compliant)

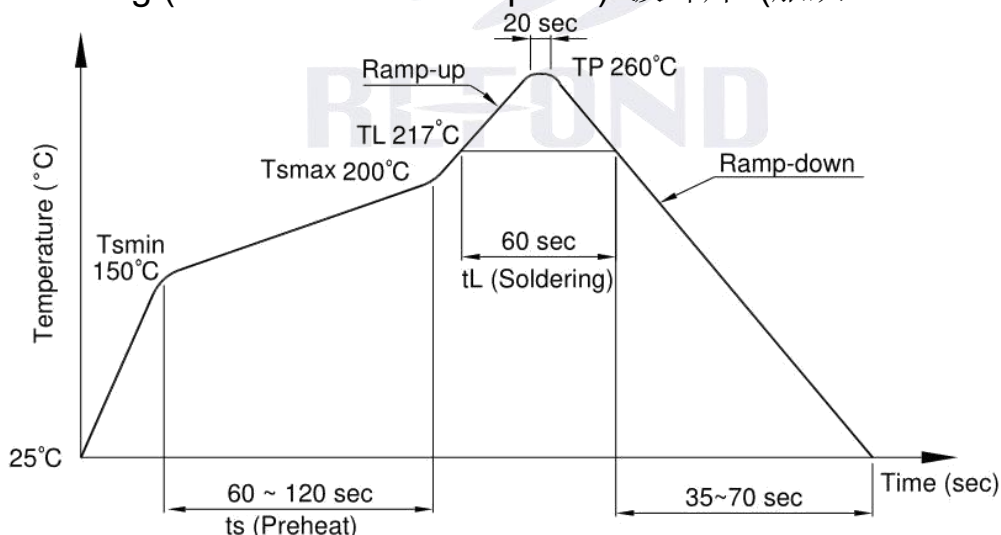
#### IR 回流焊 (服从 JEDEC-STD-020C 标准)

One time soldering reflow is recommended within the condition of temperature and time profile shown below. Do not solder more than three times.

一次回流焊推荐使用以下的温度条件和时间，不允许焊接超过三次。

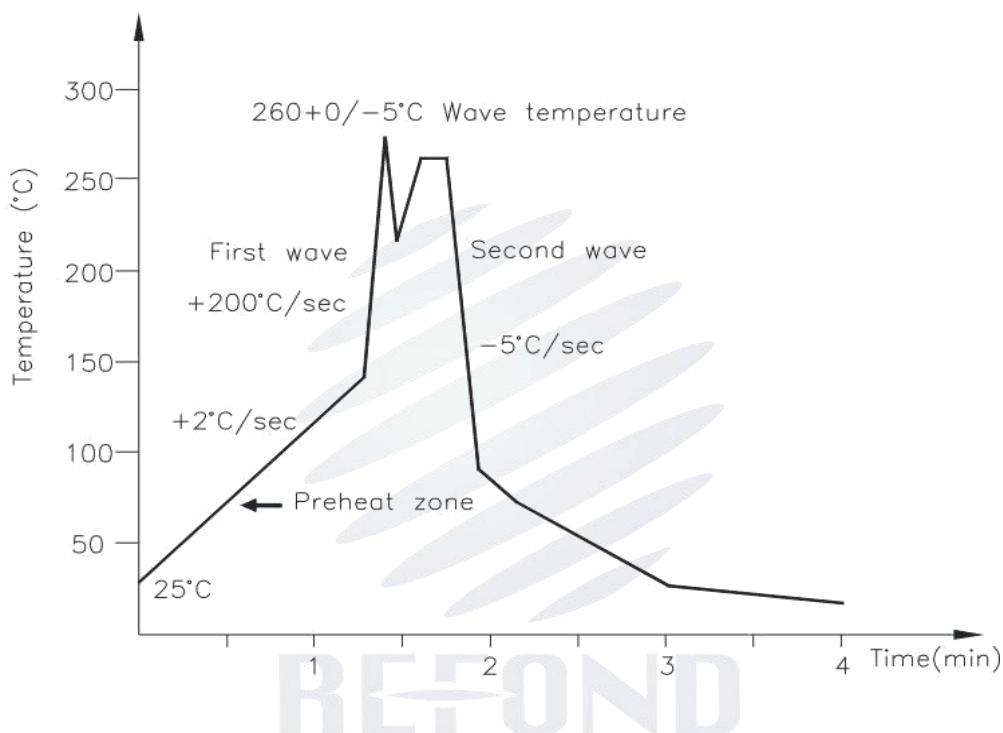
Profile item 程序项目	Conditions 条件
Preheat 预热	
- Temperature Min ( $T_{Smin}$ ) 最小温度( $T_{Smin}$ )	150°C
- Temperature Max ( $T_{Smax}$ ) 最大温度( $T_{Smax}$ )	200°C
- Time (min to max) (ts) 时间 (从最小到最大)	90±30 sec
Soldering zone 焊接时	
- Temperature (TL) 温度	217°C
- Time (tL) 时间	60sec
Peak Temperature( $T_P$ )尖峰温度	260°C
Ramp-up rate 上升速率	3°C / sec max.
Ramp-down rate 下降速率	3~6°C / sec

(2).Wave soldering (JEDEC22A111 compliant) 波峰焊 (服从 JEDEC22A111 标准)



One time soldering is recommended within the condition of temperature.  
一次焊接推荐使用以下温度条件。

Temperature 温度	260+0/-5°C
Time 时间	10 sec
Preheat temperature 预热温度	25 to 140°C
Preheat time 预热时间	30 to 80sec

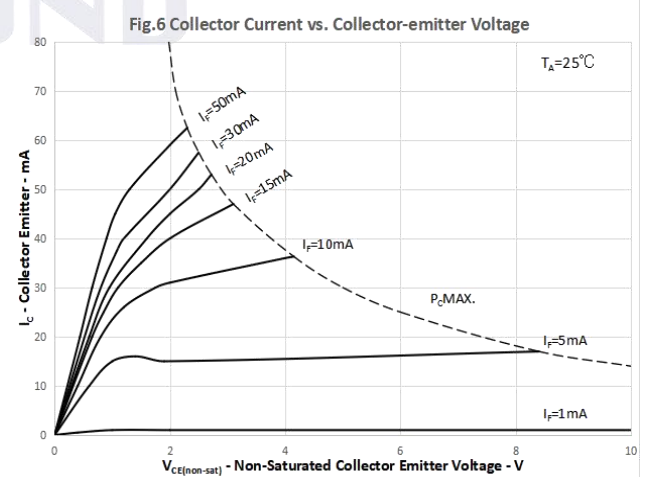
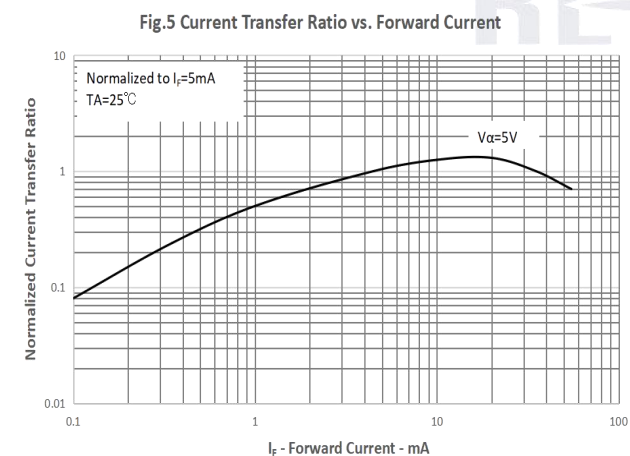
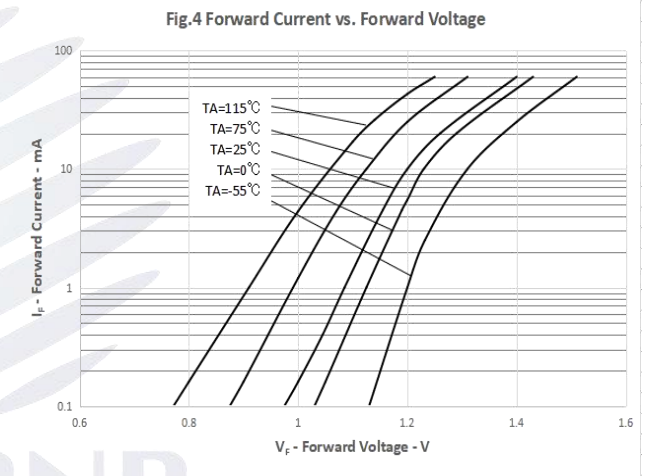
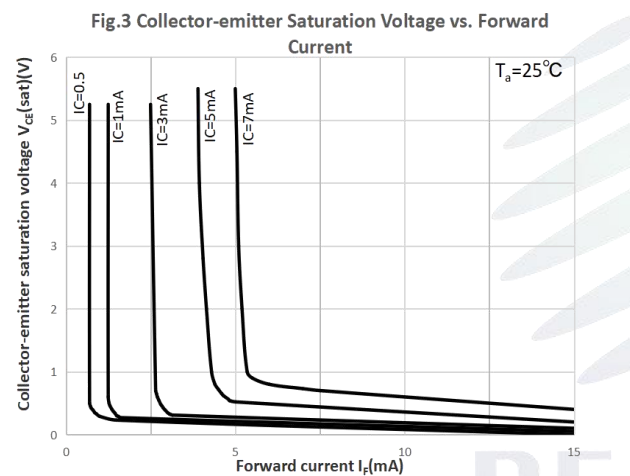
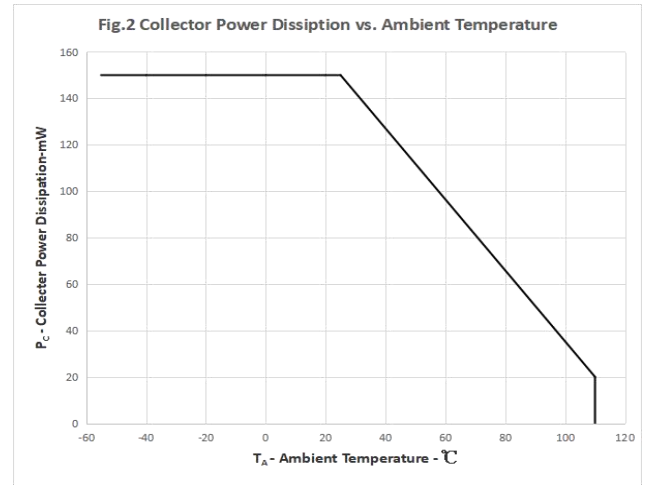
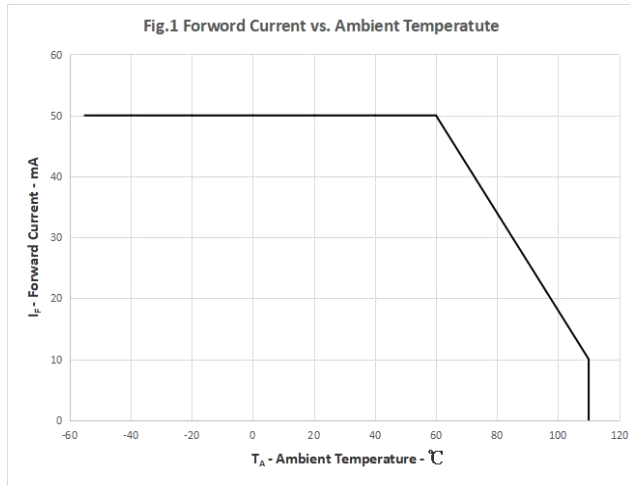


### (3).Hand soldering by soldering iron 电烙铁手工焊接

Allow single lead soldering in every single process. One time soldering is recommended.  
允许在每道工序中进行单个焊接，推荐一次焊接。

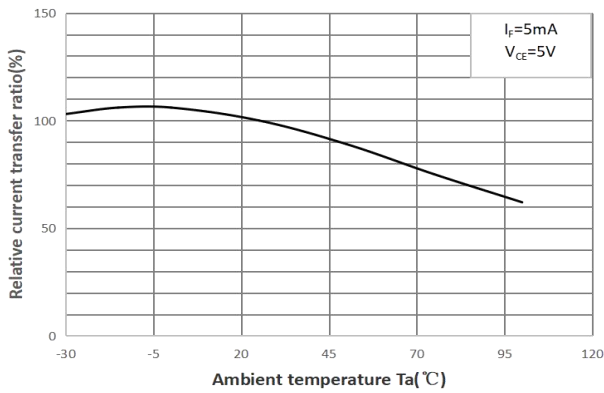
Temperature 温度	380+0/-5°C
Time 时间	3 sec max

# 13.Characteristics Curves 特性曲线

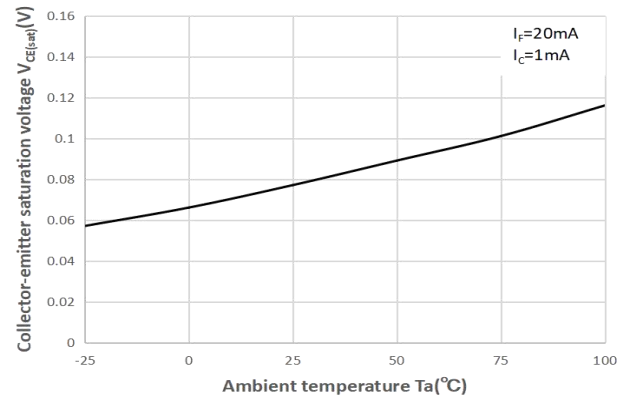




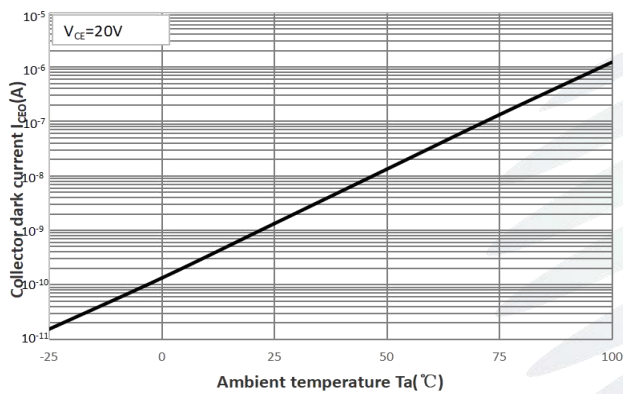
**Fig.7 Relative Current Transfer Ratio vs. Ambient Temperature**



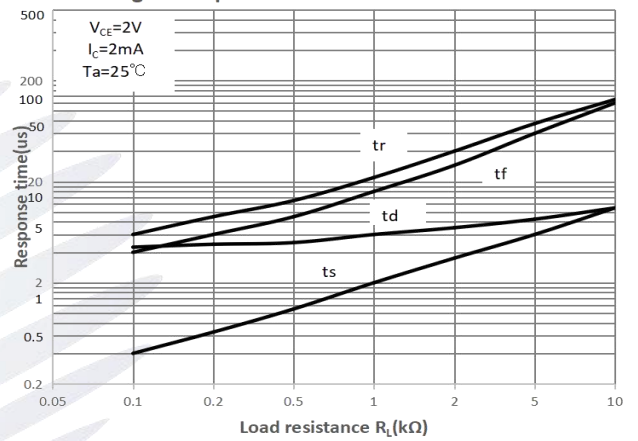
**Fig.8 Collector-emitter Saturation Voltage vs. Ambient Temperature**



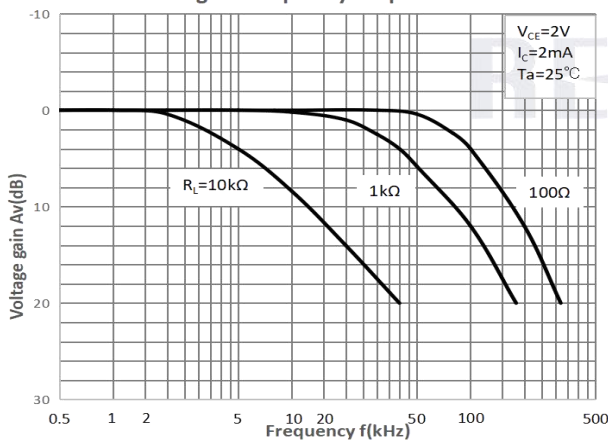
**Fig.9 Collector Dark Current vs. Ambient Temperature**



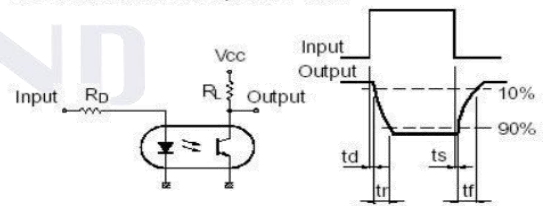
**Fig.10 Response Time vs. Load Resistance**



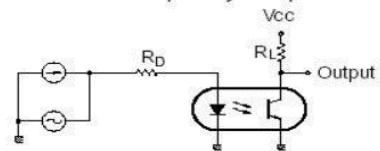
**Fig.11 Frequency Response**



**Test Circuit for Response Time**



**Test Circuit for Frequency Response**





[www.refond.com](http://www.refond.com)

REFOND

Declare 申明

This specification is written both in English and in Chinese and the latter is formal.

产品规格书以中英文方式书写，若有冲突以中文版本为准。