

HS6E Subminiature Interlock Switches with Solenoid

Small interlock switch with five poles and solenoid.

Ideal for applications in tight spaces.

- Compact body: 75 × 15 × 75 mm
15-mm-wide, thinnest solenoid interlock switch in the world.
- Reversible mounting and angled cable allow four actuator insertion directions.
- Energy saving. 24V DC, 110 mA (solenoid: 100 mA, LED: 10 mA).
Can be driven directly by a controller.
- Manual unlocking possible on three sides.
- LED indicator shows solenoid operation

Spring Lock

- Automatically locks the actuator without power applied to the solenoid.
- After the machine stops, unlocking is completed by the solenoid.
- Manual unlocking is possible on three sides in the event of power failure or maintenance.

Solenoid Lock

- The actuator is locked when energized.
- The actuator is unlocked when de-energized.
- Flexible locking function can be achieved, for an application where locking is not required and sudden stopping of a machine must be prevented.



Ratings

Contact Ratings

Rated Insulation Voltage (Ui) (Note 1)		300V (door monitor contact) 150V (lock monitor contact) 30V (between LED or solenoid and ground)				
Rated Thermal Current (Ith)		Operating temperature -25 to 35°C 2.5A (up to 2 circuits) 1.0A (3 or more circuits) Operating temperature 35 to 50°C 1.0A (1 circuit) 0.5A (2 or more circuits)				
Rated Voltage (Ue)		30V	125V	250V		
Rated Current (Ie) *	Main & Lock Monitor Circuits	AC	Resistive load (AC-12)	—	2A	—
		DC	Resistive load (DC-12)	2A	0.4A	—
	Door Monitor Circuit	AC	Resistive load (AC-12)	—	2.5A	1.5A
		DC	Resistive load (DC-12)	2.5A	1.1A	0.55A
	Door Monitor Circuit	AC	Inductive Load (AC-15)	—	1.5A	0.75A
		DC	Inductive Load (DC-13)	2.3A	0.55A	0.27A

- Minimum applicable load (reference value): 3V AC/DC, 5 mA

Approved ratings

	TÜV	UL/c-UL	CCC
Door Monitor Contact	AC-15 240V/0.75A DC-13 250V/0.27A DC-13 30V/2.3A	240V AC/0.75A Pilot Duty 250V DC/0.27A Pilot Duty C300 Q300	AC-15 240V/0.75A DC-13 30V/2.3A
Lock Monitor Contact	AC-15 125V/1A DC-13 125V/0.22A DC-13 30V/1A	125V AC/1A Pilot Duty 125V DC/0.22A Pilot Duty DC-13 30V/1A Pilot Duty	AC-15 125V/1A DC-13 30V/1A

Solenoid/Indicator

Locking Mechanism	Spring Lock	Solenoid Lock
Rated Voltage	24V DC (100% duty cycle)	
Rated Current	110 mA (solenoid 100 mA, LED 10 mA) (initial value)	
Solenoid	Coil Resistance	240Ω (at 20°C)
	Pickup Voltage	Rated voltage × 85% maximum (at 20°C)
	Dropout Voltage	Rated voltage × 10% minimum (at 20°C)
	Maximum Continuous Applicable Voltage	Rated voltage × 110%
	Maximum Continuous Applicable Time	Continuous
Insulation Class	Class F	
Indicator	Light Source	LED
	Illumination Color	Green

Specifications

Applicable Standards	ISO14119 IEC60947-5-1 EN60947-5-1 (TÜV approved) EN1088 (TÜV approved) GS-ET-19 (TÜV approved) UL508 (c-UL listed) CSA C22.2 No. 14 (c-UL listed) IEC 60204-1/EN 60204-1 (applicable standards for use)
Operating Temperature	-25 to +50°C (no freezing)
Relative Humidity	45 to 85% (no condensation)
Storage Temperature	-40 to +80°C (no freezing)
Pollution Degree	3
Impulse Withstand Voltage	Main & lock monitor circuits: 1.5 kV Door monitor circuit: 2.5 kV Between solenoid/LED and ground: 0.5 kV
Insulation Resistance (500V DC megger)	Between live and dead metal parts: 100 MΩ minimum Between terminals of different poles: 100 MΩ minimum
Contact Resistance	300 mΩ maximum (initial value, 1m cable) 500 mΩ maximum (initial value, 3m cable) 700 mΩ maximum (initial value, 5m cable)
Electric Shock Protection	Class II (IEC 61140)
Degree of Protection	IP67 (IEC 60529)
Shock Resistance	Operating extremes: 100 m/s ² (10G) Damage limits: 1000 m/s ² (100G)
Vibration Resistance	Operating extremes: 10 to 55 Hz, amplitude 0.35 mm Damage limits: 30 Hz, amplitude 1.5 mm
Actuator Operating Speed	0.05 to 1.0 m/s
Direct Opening Travel	8.0 mm minimum
Direct Opening Force	60N minimum
Actuator Retention Force	500N minimum (GS-ET-19)
Operating Frequency	900 operations/h
Mechanical Durability	1,000,000 operations minimum (GS-ET-19)
Electrical Durability	100,000 operations minimum (rated load) 1,000,000 operations minimum (24V AC/DC, 100 mA) (operating frequency 900 operations/h)
Conditional Short-circuit Current	50A (250V) (Use 250V/10A fast-blow fuse for short-circuit protection.)
Cable	UL2464, No. 22 AWG (12-core: 0.3 mm ² or equivalent/core)
Cable Diameter	ø7.6 mm
Weight (approx.)	220g (1m cable) 410g (3m cable) 600g (5m cable)

HS6E Subminiature Interlock Switches with Solenoid

Standard

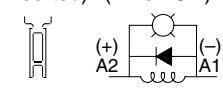
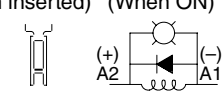
Lock Mechanism	Circuit Number	Contact Configuration	Cable Length	Part No.
Spring Lock	L	(When inserted) (When ON) 	1m	HS6E-L44B01-G
		Main Circuit: 1NC+1NC, Door Monitor Circuit: 2NC Lock Monitor Circuit: 1NO Main Circuit: 11 12 41 42 Monitor Circuit: 21 22 53 54 Monitor Circuit: 31 32	3m	HS6E-L44B03-G
		5m	HS6E-L44B05-G	
	M	Main Circuit: 1NC+1NC, Door Monitor Circuit: 2NC Lock Monitor Circuit: 1NC Main Circuit: 11 12 41 42 Monitor Circuit: 21 22 51 52 Monitor Circuit: 31 32	1m	HS6E-M44B01-G
		3m	HS6E-M44B03-G	
		5m	HS6E-M44B05-G	
	N	Main Circuit: 1NC+1NC, Door Monitor Circuit: 1NC, 1NO Lock Monitor Circuit: 1NO Main Circuit: 11 12 41 42 Monitor Circuit: 21 22 53 54 Monitor Circuit: 33 34	1m	HS6E-N44B01-G
		3m	HS6E-N44B03-G	
		5m	HS6E-N44B05-G	
	P	Main Circuit: 1NC+1NC, Door Monitor Circuit: 1NC, 1NO Lock Monitor Circuit: 1NC Main Circuit: 11 12 41 42 Monitor Circuit: 21 22 51 52 Monitor Circuit: 33 34	1m	HS6E-P44B01-G
		3m	HS6E-P44B03-G	
		5m	HS6E-P44B05-G	
Solenoid Lock	L	(When inserted) (When ON) 	1m	HS6E-L7Y4B01-G
		Main Circuit: 1NC+1NC, Door Monitor Circuit: 2NC Lock Monitor Circuit: 1NO Main Circuit: 11 12 41 42 Monitor Circuit: 21 22 53 54 Monitor Circuit: 31 32	3m	HS6E-L7Y4B03-G
		5m	HS6E-L7Y4B05-G	
	M	Main Circuit: 1NC+1NC, Door Monitor Circuit: 2NC Lock monitor Circuit: 1NC Main Circuit: 11 12 41 42 Monitor Circuit: 21 22 51 52 Monitor Circuit: 31 32	1m	HS6E-M7Y4B01-G
		3m	HS6E-M7Y4B03-G	
		5m	HS6E-M7Y4B05-G	
	N	Main Circuit: 1NC+1NC, Door Monitor Circuit: 1NC, 1NO Lock Monitor Circuit: 1NO Main Circuit: 11 12 41 42 Monitor Circuit: 21 22 53 54 Monitor Circuit: 33 34	1m	HS6E-N7Y4B01-G
		3m	HS6E-N7Y4B03-G	
		5m	HS6E-N7Y4B05-G	
	P	Main Circuit: 1NC+1NC, Door Monitor Circuit: 1NC, 1NO Lock Monitor Circuit: 1NC Main Circuit: 11 12 41 42 Monitor Circuit: 21 22 51 52 Monitor Circuit: 33 34	1m	HS6E-P7Y4B01-G
		3m	HS6E-P7Y4B03-G	
		5m	HS6E-P7Y4B05-G	

- The contact configurations show the contact status when the actuator is inserted and locked.
- LED color is G (green) only.
- Actuators are not supplied with the interlock switch and must be ordered separately.

HS6E Subminiature Interlock Switches with Solenoid





5-circuit Independent Output

Lock Mechanism	Circuit Number	Contact Configuration	Cable Length	Part No.
Spring Lock	VL	<p>Door monitor circuit: 3NC Lock monitor circuit: 1NC, 1NO</p> <p>Monitor Circuit: 11 12 41 42 Monitor Circuit: 21 22 53 54 Monitor Circuit: 31 32</p>	1m	HS6E-VL44B01-G
			3m	HS6E-VL44B03-G
			5m	HS6E-VL44B05-G
	VM	<p>Door monitor circuit: 3NC Lock monitor circuit: 2NC</p> <p>Monitor Circuit: 11 12 41 42 Monitor Circuit: 21 22 51 52 Monitor Circuit: 31 32</p>	1m	HS6E-VM44B01-G
			3m	HS6E-VM44B03-G
			5m	HS6E-VM44B05-G
	VN	<p>Door monitor circuit: 2NC, 1NO Lock monitor circuit: 1NC, 1NO</p> <p>Monitor Circuit: 11 12 41 42 Monitor Circuit: 21 22 53 54 Monitor Circuit: 33 34</p>	1m	HS6E-VN44B01-G
			3m	HS6E-VN44B03-G
			5m	HS6E-VN44B05-G
	VP	<p>Door monitor circuit: 2NC, 1NO Lock monitor circuit: 2NC</p> <p>Monitor Circuit: 11 12 41 42 Monitor Circuit: 21 22 51 52 Monitor Circuit: 33 34</p>	1m	HS6E-VP44B01-G
			3m	HS6E-VP44B03-G
			5m	HS6E-VP44B05-G
Solenoid Lock	VL	<p>Door monitor circuit: 3NC Lock monitor circuit: 1NC, 1NO</p> <p>Monitor Circuit: 11 12 41 42 Monitor Circuit: 21 22 53 54 Monitor Circuit: 31 32</p>	1m	HS6E-VL7Y4B01-G
			3m	HS6E-VL7Y4B03-G
			5m	HS6E-VL7Y4B05-G
	VM	<p>Door monitor circuit: 3NC Lock monitor circuit: 2NC</p> <p>Monitor Circuit: 11 12 41 42 Monitor Circuit: 21 22 51 52 Monitor Circuit: 31 32</p>	1m	HS6E-VM7Y4B01-G
			3m	HS6E-VM7Y4B03-G
			5m	HS6E-VM7Y4B05-G
	VN	<p>Door monitor circuit: 2NC, 1NO Lock monitor circuit: 1NC, 1NO</p> <p>Monitor Circuit: 11 12 41 42 Monitor Circuit: 21 22 53 54 Monitor Circuit: 33 34</p>	1m	HS6E-VN7Y4B01-G
			3m	HS6E-VN7Y4B03-G
			5m	HS6E-VN7Y4B05-G
	VP	<p>Door monitor circuit: 2NC, 1NO Lock monitor circuit: 2NC</p> <p>Monitor Circuit: 11 12 41 42 Monitor Circuit: 21 22 51 52 Monitor Circuit: 33 34</p>	1m	HS6E-VP7Y4B01-G
			3m	HS6E-VP7Y4B03-G
			5m	HS6E-VP7Y4B05-G

- The contact configurations show the contact status when the actuator is inserted and locked.
- LED color is G (green) only.
- Actuators are not supplied with the interlock switch and must be ordered separately.

HS6E Subminiature Interlock Switches with Solenoid

Actuator

Shape	Part No.	Remarks
	HS9Z-A61	The retention force of HS9Z-A61 actuator is 500N maximum. Do not apply excessive load, otherwise the actuator may fall off the door.
	HS9Z-A62	The retention force of HS9Z-A62 actuator is 100N maximum. Do not apply excessive load, otherwise the actuator may fall off the door. When retention force of 100N or more is required, use the HS9Z-A62S actuator.
	HS9Z-A62S	The retention force of HS9Z-A62S actuator is 500N maximum. Do not apply excessive load, otherwise the actuator may fall off the door.
	HS9Z-A65	The HS9Z-A65 and HS9Z-A66 have the metal key installed in opposite directions. Select actuator by determining the required moving direction in consideration of the door and interlock switch. See pages 17, 22, and 23. The retention force of HS9Z-A65 and HS9Z-A66 actuators is 500N maximum.
	HS9Z-A66	

Part No. Development

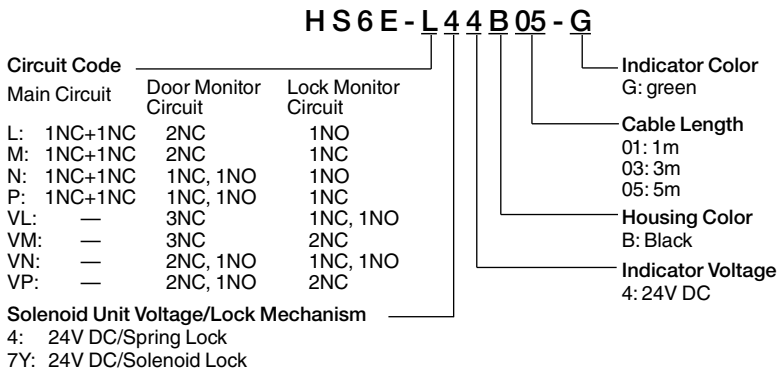

HS6E Subminiature Interlock Switches with Solenoid

Dimensions

Interlock Switch

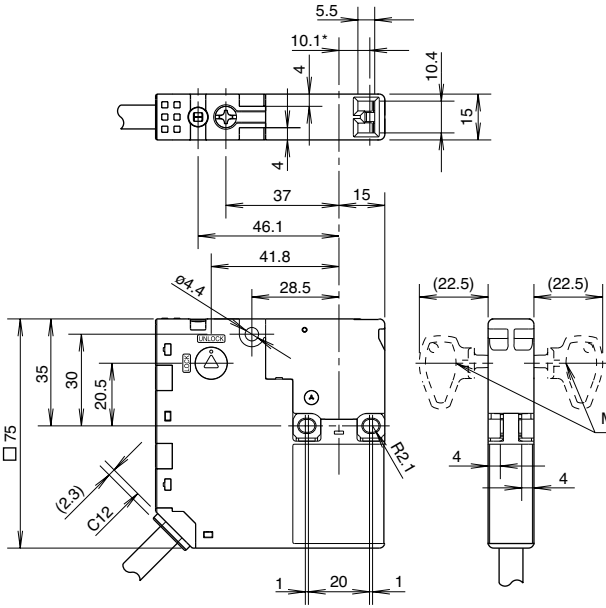

* Actuator center

• Mounting Hole Layout

Hole for Manual Unlocking $\phi 12$ (reference)
3-M4 Screw ($\phi 4.3$ or M4 tapped hole)

Use three mounting screws to install the interlock switch. The switch cannot be installed properly using only one or two screws, resulting in possible malfunction.

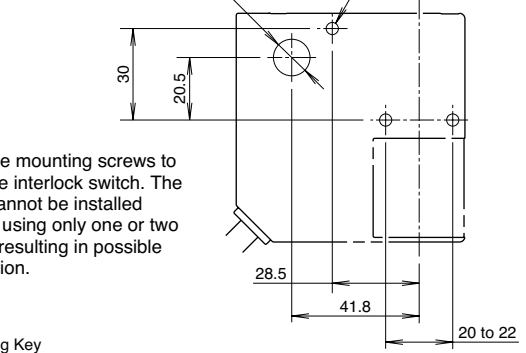

Manual Unlocking Key

3-M4 Screw ($\phi 4.3$ or M4 tapped hole)
Hole for Manual Unlocking $\phi 12$ (reference)

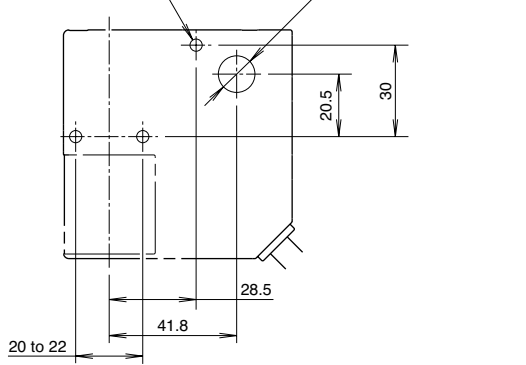

When using straight actuator (HS9Z-A61)

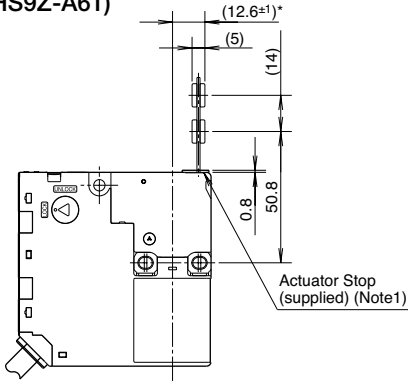

When using right-angle actuator (HS9Z-A62S)

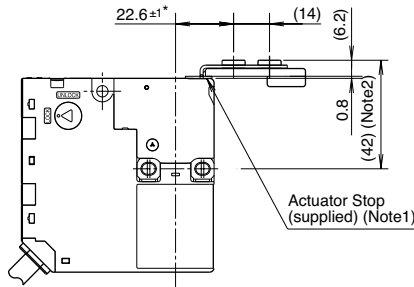

When using horizontal/vertical angle adjustable actuator (HS9Z-A65/A66)

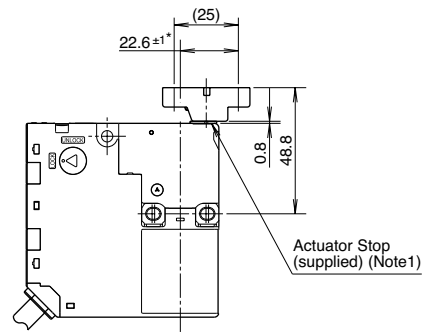

Note 1: Remove the actuator stop after mounting the actuator.
Note 2: 41.4 when using HS9Z-A62.

* The retention force of the HS9Z-A62 actuator is 100N. When tensile force exceeding 100N is expected, use the HS9Z-A62S actuator (with a mounting plate).

Actuator Mounting Reference Position

As shown in the figure on the right, the mounting reference position of the actuator when inserted in the interlock switch is:

The actuator stop on the actuator lightly touches the interlock switch.

Note: After mounting the actuator, remove the actuator stop from the actuator.

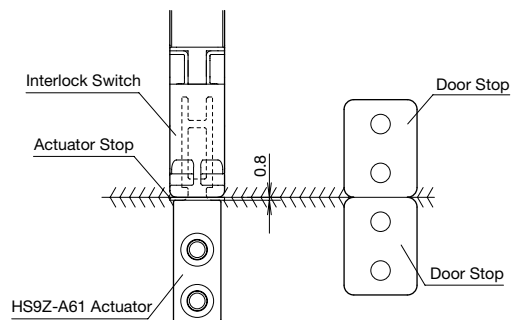

HS6E Subminiature Interlock Switches with Solenoid

Dimensions

Straight Actuator (HS9Z-A61)

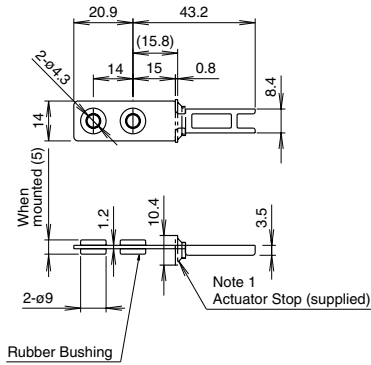

Right-angle Actuator (HS9Z-A62)

The retention force of the HS9Z-A62 actuator is 100N. When tensile force exceeding 100N is expected, use the HS9Z-A62S actuator.

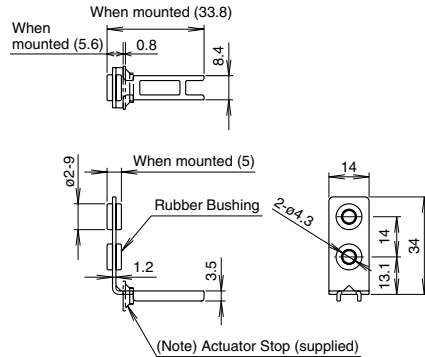

Right-angle Actuator with Mounting Plate (HS9Z-A62S)

Note: See page 23 for actuator installation.

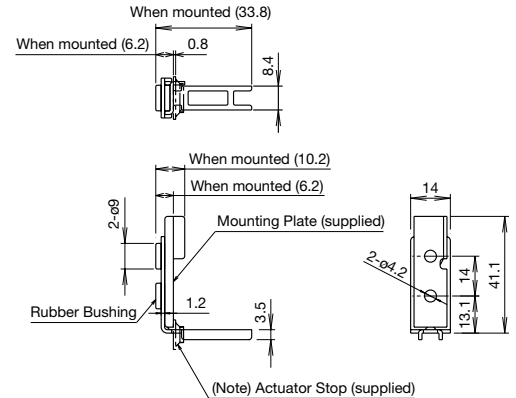

Note: The actuator stop is used to adjust the actuator position. Remove the actuator stop after the actuator is mounted.

Angle Adjustable Actuator (HS9Z-A65)

Horizontal Adjustment

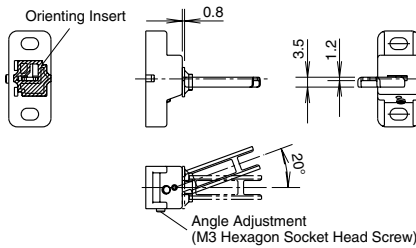

Vertical Adjustment

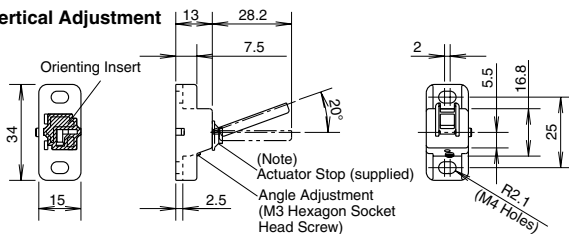

Angle Adjustable Actuator (HS9Z-A66)

The HS9Z-A65 and HS9Z-A66 have the metal key inserted in opposite directions.

Horizontal Adjustment

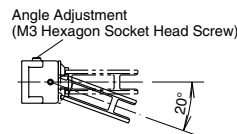

Vertical Adjustment

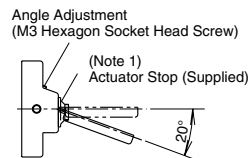

Actuator Adjustment Orientation

The orientation of actuator adjustment (horizontal/vertical) can be changed using the orienting insert (white plastic) installed on the back of the actuator.

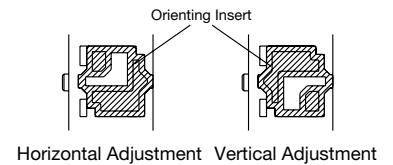

Note: The base is made of glass-reinforced PA66 (66 nylon). Angle adjustment screws are stainless steel. When using adhesive on screws, take material compatibility into consideration.

Actuator Mounting Hole Layout (horizontal/vertical swing)

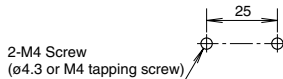

Accessory

Description	Part No.
Manual Unlock Key (long)	HS9Z-T3

Manual Unlock Key (supplied) (plastic)

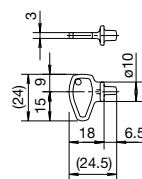

Manual Unlock Key (long) (metal)

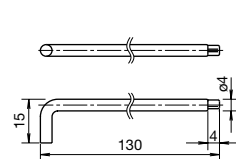

All dimensions in mm.

HS6E Subminiature Interlock Switches with Solenoid

Circuit Diagrams and Operating Characteristics

Standard – Spring Lock

Interlock Switch Status		Status 1	Status 2	Status 3	Status 4	Unlocking using Manual Unlock Key	
		<ul style="list-style-type: none"> Door closed Machine ready to operate Solenoid de-energized 	<ul style="list-style-type: none"> Door closed Machine cannot be operated Solenoid energized 	<ul style="list-style-type: none"> Door open Machine cannot be operated Solenoid energized 	<ul style="list-style-type: none"> Door open Machine cannot be operated Solenoid de-energized 		<ul style="list-style-type: none"> Door closed Machine cannot be operated Solenoid de-energized
Door Status							
Circuit Diagram (Example: HS6E-N4)							
Door		Closed (locked)	Closed (unlocked)	Open	Open	Closed (unlocked)	
Model and Circuit Diagram	HS6E-L4 (When inserted) (When ON) Door Lock Monitor Main Circuit: 11, 12, 41, 42 Monitor Circuit: 21, 22, 53, 54 Monitor Circuit: 31, 32	Main Circuit 11-42	ON (closed)	OFF (open)	OFF (open)	OFF (open)	OFF (open)
		Door Monitor Circuit (door closed) 21-22	ON (closed)	ON (closed)	OFF (open)	OFF (open)	ON (closed)
		Door Monitor Circuit (door closed) 31-32	ON (closed)	ON (closed)	OFF (open)	OFF (open)	ON (closed)
		Lock Monitor Circuit (unlocked) 53-54	OFF (open)	ON (closed)	ON (closed)	ON (closed)	ON (closed)
	HS6E-M4 Main Circuit: 11, 12, 41, 42 Monitor Circuit: 21, 22, 51, 52 Monitor Circuit: 31, 32	Main Circuit 11-42	ON (closed)	OFF (open)	OFF (open)	OFF (open)	OFF (open)
		Door Monitor Circuit (door closed) 21-22	ON (closed)	ON (closed)	OFF (open)	OFF (open)	ON (closed)
		Door Monitor Circuit (door closed) 31-32	ON (closed)	ON (closed)	OFF (open)	OFF (open)	ON (closed)
		Lock Monitor Circuit (locked) 51-52	ON (closed)	OFF (open)	OFF (open)	OFF (open)	OFF (open)
	HS6E-N4 Main Circuit: 11, 12, 41, 42 Monitor Circuit: 21, 22, 53, 54 Monitor Circuit: 33, 34	Main Circuit 11-42	ON (closed)	OFF (open)	OFF (open)	OFF (open)	OFF (open)
		Door Monitor Circuit (door closed) 21-22	ON (closed)	ON (closed)	OFF (open)	OFF (open)	ON (closed)
		Door Monitor Circuit (door open) 33-34	OFF (open)	OFF (open)	ON (closed)	ON (closed)	OFF (open)
		Lock Monitor Circuit (unlocked) 53-54	OFF (open)	ON (closed)	ON (closed)	ON (closed)	ON (closed)
	HS6E-P4 Main Circuit: 11, 12, 41, 42 Monitor Circuit: 21, 22, 51, 52 Monitor Circuit: 33, 34	Main Circuit 11-42	ON (closed)	OFF (open)	OFF (open)	OFF (open)	OFF (open)
		Door Monitor Circuit (door closed) 21-22	ON (closed)	ON (closed)	OFF (open)	OFF (open)	ON (closed)
		Door Monitor Circuit (door open) 33-34	OFF (open)	OFF (open)	ON (closed)	ON (closed)	OFF (open)
		Lock Monitor Circuit (locked) 51-52	ON (closed)	OFF (open)	OFF (open)	OFF (open)	OFF (open)
Solenoid Power A1-A2 (all model)		OFF (de-energized)	ON (energized)	ON (energized)	OFF (de-energized)	OFF (de-energized)	

Main circuit: Connected to the machine drive control circuit, sending the interlock signals of the protective door.

Monitor circuit: Sends the monitoring signals of open/closed and lock/unlocked statuses of the protective door.

Operation Characteristics (reference)

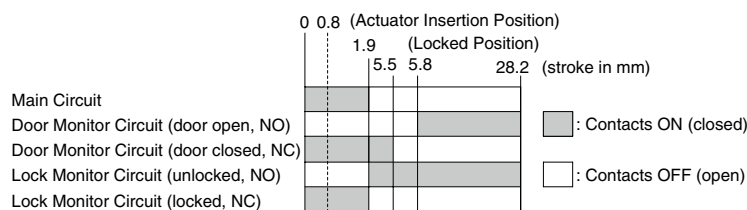

• The characteristics shown in the chart above are of the HS9Z-A61, -A62, -A65, and -A66 actuators. For the HS9Z-A62S actuator, subtract 0.6 mm.

• The characteristics show the contact status when the actuator enters an entry slot of an interlock switch.

HS6E Subminiature Interlock Switches with Solenoid

Standard – Solenoid Lock

Interlock Switch Status		Status 1	Status 2	Status 3	Status 4	Unlocking using Manual Unlock Key	
		<ul style="list-style-type: none"> Door closed Machine ready to operate Solenoid energized 	<ul style="list-style-type: none"> Door closed Machine cannot be operated Solenoid de-energized 	<ul style="list-style-type: none"> Door open Machine cannot be operated Solenoid de-energized 	<ul style="list-style-type: none"> Door open Machine cannot be operated Solenoid energized 		<ul style="list-style-type: none"> Door closed Machine cannot be operated Solenoid de-energized
Door Status							
Circuit Diagram (Example: HS6E-N7Y)							
Door		Closed (locked)	Closed (unlocked)	Open	Open	Closed (unlocked)	
Model and Circuit Diagram	HS6E-L7Y (When inserted) Door Lock Monitor Main Circuit: 11, 12, 41, 42 Monitor Circuit: 21, 22, 53, 54 Monitor Circuit: 31, 32	Main Circuit 11-42	ON (closed)	OFF (open)	OFF (open)	OFF (open)	OFF (open)
		Door Monitor Circuit (door closed) 21-22	ON (closed)	ON (closed)	OFF (open)	OFF (open)	ON (closed)
		Door Monitor Circuit (door closed) 31-32	ON (closed)	ON (closed)	OFF (open)	OFF (open)	ON (closed)
		Lock Monitor Circuit (unlocked) 53-54	OFF (open)	ON (closed)	ON (closed)	ON (closed)	ON (closed)
	HS6E-M7Y Main Circuit: 11, 12, 41, 42 Monitor Circuit: 21, 22, 51, 52 Monitor Circuit: 31, 32	Main Circuit 11-42	ON (closed)	OFF (open)	OFF (open)	OFF (open)	OFF (open)
		Door Monitor Circuit (door closed) 21-22	ON (closed)	ON (closed)	OFF (open)	OFF (open)	ON (closed)
		Door Monitor Circuit (door closed) 31-32	ON (closed)	ON (closed)	OFF (open)	OFF (open)	ON (closed)
		Lock Monitor Circuit (locked) 51-52	ON (closed)	OFF (open)	OFF (open)	OFF (open)	OFF (open)
	HS6E-N7Y Main Circuit: 11, 12, 41, 42 Monitor Circuit: 21, 22, 53, 54 Monitor Circuit: 33, 34	Main Circuit 11-42	ON (closed)	OFF (open)	OFF (open)	OFF (open)	OFF (open)
		Door Monitor Circuit (door closed) 21-22	ON (closed)	ON (closed)	OFF (open)	OFF (open)	ON (closed)
		Door Monitor Circuit (door open) 33-34	OFF (open)	OFF (open)	ON (closed)	ON (closed)	OFF (open)
		Lock Monitor Circuit (unlocked) 53-54	OFF (open)	ON (closed)	ON (closed)	ON (closed)	ON (closed)
	HS6E-P7Y Main Circuit: 11, 12, 41, 42 Monitor Circuit: 21, 22, 51, 52 Monitor Circuit: 33, 34	Main Circuit 11-42	ON (closed)	OFF (open)	OFF (open)	OFF (open)	OFF (open)
		Door Monitor Circuit (door closed) 21-22	ON (closed)	ON (closed)	OFF (open)	OFF (open)	ON (closed)
		Door Monitor Circuit (door open) 33-34	OFF (open)	OFF (open)	ON (closed)	ON (closed)	OFF (open)
		Lock Monitor Circuit (locked) 51-52	ON (closed)	OFF (open)	OFF (open)	OFF (open)	OFF (open)
Solenoid Power A1-A2 (all model)		ON (energized)	OFF (de-energized)	OFF (de-energized)	ON (energized) (Note 2)	OFF (de-energized) to ON (re-energized) (Note 1) (Note 2)	

Main circuit: Connected to the machine drive control circuit, sending the interlock signals of the protective door.

Monitor circuit: Sends the monitoring signals of open/closed and lock/unlocked statuses of the protective door.

Note 1: Do not attempt manual unlocking while the solenoid is energized.

Note 2: Do not energize the solenoid for a long period of time while the door is open or while the door is unlocked manually using the manual unlock key.

Operation Characteristics (reference)

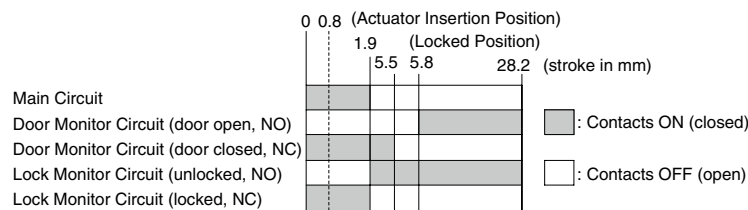

• The characteristics shown in the chart above are of the HS9Z-A61, -A62, -A65, and -A66 actuators. For the HS9Z-A62S actuator, subtract 0.6 mm.

• The characteristics show the contact status when the actuator enters an entry slot of an interlock switch.

HS6E Subminiature Interlock Switches with Solenoid

5-circuit Independent Output – Spring Lock

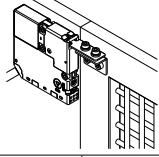
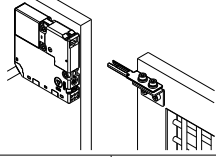
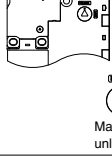
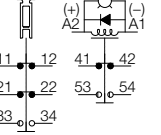
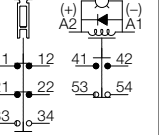
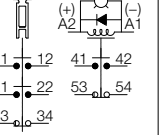
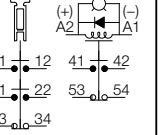
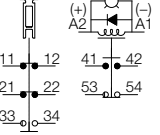
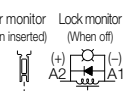
		Status 1	Status 2	Status 3	Status 4	Unlocking using Manual Unlock Key		
Interlock Switch Status		<ul style="list-style-type: none"> Door closed Machine ready to operate Solenoid energized 	<ul style="list-style-type: none"> Door closed Machine cannot be operated Solenoid energized 	<ul style="list-style-type: none"> Door open Machine cannot be operated Solenoid energized 	<ul style="list-style-type: none"> Door open Machine cannot be operated Solenoid de-energized 	<ul style="list-style-type: none"> Door closed Machine cannot be operated Solenoid de-energized 		
Door Status						 Manually unlocked		
Circuit Diagram (Example: HS6E-VN4)								
Door		Closed (locked)	Closed (unlocked)	Open	Open	Closed (unlocked)		
Model and Contact Configuration	HS6E-VL4 Door monitor (When inserted) Lock monitor (When off)  Monitor Circuit: 11-12 41-42 Monitor Circuit: 21-22 53-54 Monitor Circuit: 31-32		Door Monitor Circuit (door closed) 11-12					
			Door Monitor Circuit (door closed) 21-22					
			Door Monitor Circuit (door closed) 31-32					
			Lock Monitor Circuit (locked) 41-42					
			Lock Monitor Circuit (unlocked) 53-54					
	HS6E-VM4 Monitor Circuit: 11-12 41-42 Monitor Circuit: 21-22 51-52 Monitor Circuit: 31-32		Door Monitor Circuit (door closed) 11-12					
			Door Monitor Circuit (door closed) 21-22					
			Door Monitor Circuit (door closed) 31-32					
			Lock Monitor Circuit (locked) 41-42					
			Lock Monitor Circuit (locked) 51-52					
	HS6E-VN4 Monitor Circuit: 11-12 41-42 Monitor Circuit: 21-22 53-54 Monitor Circuit: 33-34		Door Monitor Circuit (door closed) 11-12					
			Door Monitor Circuit (door closed) 21-22					
			Door Monitor Circuit (door open) 33-34					
			Lock Monitor Circuit (locked) 41-42					
			Lock Monitor Circuit (unlocked) 53-54					
	HS6E-VP4 Monitor Circuit: 11-12 41-42 Monitor Circuit: 21-22 51-52 Monitor Circuit: 33-34		Door Monitor Circuit (door closed) 11-12					
			Door Monitor Circuit (door closed) 21-22					
			Door Monitor Circuit (door open) 33-34					
			Lock Monitor Circuit (locked) 41-42					
			Lock Monitor Circuit (locked) 51-52					
Solenoid Power A1-A2 (all model)		OFF (de-energized)	ON (energized)	ON (energized)	OFF (de-energized)	OFF (de-energized)		

Monitor circuit: Sends the monitoring signals of open/closed and lock/unlocked statuses of the protective door.

Operation Characteristics (reference)

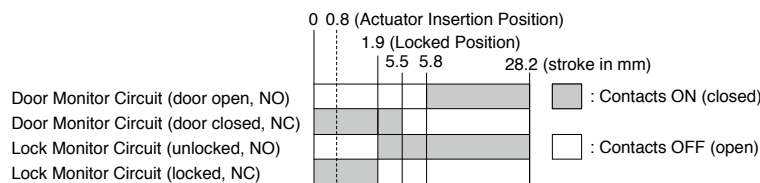

- The characteristics shown in the chart above are of the HS9Z-A61, -A62, -A65, and -A66 actuators. For the HS9Z-A62S actuator, subtract 0.6 mm.
- The characteristics show the contact status when the actuator enters an entry slot of an interlock switch.

HS6E Subminiature Interlock Switches with Solenoid

5-circuit Independent Output – Solenoid Lock

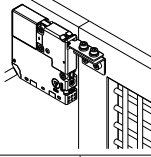
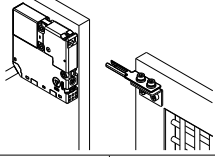
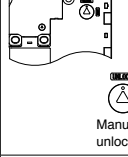
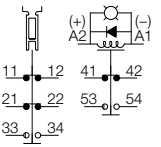
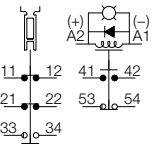
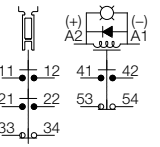
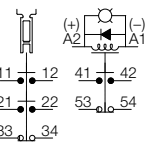
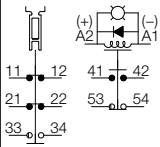
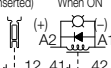
		Status 1	Status 2	Status 3	Status 4	When using Manual Unlock Key	
Interlock Switch Status		<ul style="list-style-type: none"> Door closed Machine ready to operate Solenoid energized 	<ul style="list-style-type: none"> Door closed Machine cannot be operated Solenoid de-energized 	<ul style="list-style-type: none"> Door closed Machine cannot be operated Solenoid de-energized 	<ul style="list-style-type: none"> Door open Machine cannot be operated Solenoid energized 	<ul style="list-style-type: none"> Door closed Machine cannot be operated Solenoid de-energized → energized 	
Doot Status						 Manually unlocked	
Circuit Diagram (Example: HS6E-VN7Y)							
Door		Closed (locked)	Closed (unlocked)	Open	Open	Closed (unlocked)	
Model and Contact Configuration	HS6E-VL7Y Door Monitor (When inserted) Lock Monitor (When ON)  Monitor Circuit: 11-12, 21-22, 31-32 Monitor Circuit: 41-42, 53-54	Door Monitor Circuit (door closed) 11-12					
		Door Monitor Circuit (door closed) 21-22					
		Door Monitor Circuit (door closed) 31-32					
		Lock Monitor Circuit (locked) 41-42					
		Lock Monitor Circuit (unlocked) 53-54					
	HS6E-VM7Y Monitor Circuit: 11-12, 21-22, 31-32 Monitor Circuit: 41-42, 51-52	Door Monitor Circuit (door closed) 11-12					
		Door Monitor Circuit (door closed) 21-22					
		Door Monitor Circuit (door closed) 31-32					
		Lock Monitor Circuit (locked) 41-42					
		Lock Monitor Circuit (locked) 51-52					
	HS6E-VN7Y Monitor Circuit: 11-12, 21-22, 33-34 Monitor Circuit: 41-42, 53-54	Door Monitor Circuit (door closed) 11-12					
		Door Monitor Circuit (door closed) 21-22					
		Door Monitor Circuit (door open) 33-34					
		Lock Monitor Circuit (locked) 41-42					
		Lock Monitor Circuit (unlocked) 53-54					
	HS6E-VP7Y Monitor Circuit: 11-12, 21-22, 33-34 Monitor Circuit: 41-42, 51-52	Door Monitor Circuit (door closed) 11-12					
Door Monitor Circuit (door closed) 21-22							
Door Monitor Circuit (door open) 33-34							
Lock Monitor Circuit (locked) 41-42							
	Lock Monitor Circuit (locked) 51-52						
Solenoid Power A1-A2 (all model)		ON (energized)	OFF (de-energized)	OFF (de-energized)	ON (energized) (Note 2)	(Note 1) (Note 2) OFF (de-energized) → ON (energized)	

Monitor circuit: Sends the monitoring signals of open/closed and lock/unlocked statuses of the protective door.

Note 1: Do not attempt manual unlocking while the solenoid is energized.

Note 2: Do not energize the solenoid for a long period of time while the door is open or while the door is unlocked manually using the manual unlock key.

Operation Characteristics (reference)

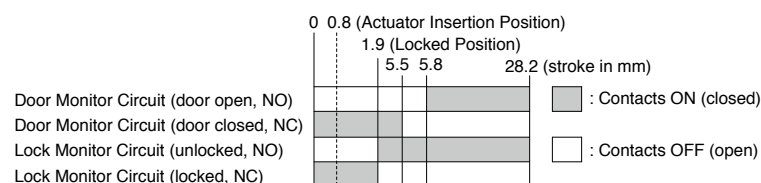

- The characteristics shown in the chart above are of the HS9Z-A61, -A62, -A65, and -A66 actuators. For the HS9Z-A62S actuator, subtract 0.6 mm.
- The characteristics show the contact status when the actuator enters an entry slot of an interlock switch.

HS6E Subminiature Interlock Switches with Solenoid

Safety Precautions

- In order to avoid electric shock or fire, turn power off before installation, removal, wiring, maintenance, or inspection of the interlock switch.
- If relays are used in the circuit between the interlock switch and the load, use only safety relays, since welded or sticking contacts of standard relays may invalidate the functions of the interlock switch. Perform a risk assessment and make a safety circuit which satisfies the requirements of the safety category.
- Do not place a PLC in the circuit between the interlock switch and the load. Safety security can be endangered in the event of a malfunction of the PLC.
- Do not disassemble or modify the interlock switch, otherwise a malfunction or an accident may occur.
- Do not install the actuator in a location where a human body may come into contact. Otherwise injury may occur.
- Solenoid lock is locked when energized, and unlocked when de-energized. When energization is interrupted due to wire disconnection or other failures, the interlock switch may be unlocked causing possible danger to the operators. Solenoid lock must not be used in applications where locking is strictly required for safety. Perform a risk assessment and determine whether solenoid lock is appropriate.

Instructions

- Regardless of door types, do not use the interlock switch as a door stop. Install a mechanical door stop at the end of the door to protect the interlock switch against excessive force.
- Do not apply excessive shock to the interlock switch when opening or closing the door. A shock to the interlock switch exceeding $1,000 \text{ m/s}^2$ may cause damage to the interlock switch.
- When unlocking, the switch may not be unlocked if a load is applied to the actuator.
- If the operating atmosphere is contaminated, use a protective cover to prevent the entry of foreign objects into the interlock switch through the actuator entry slots.
- Entry of a considerable amount of foreign objects into the interlock switch may affect the mechanism of the interlock switch and cause a malfunction.
- Do not store the interlock switches in a dusty, humid, or organic-gas atmosphere, or in an area subjected to direct sunlight.
- Use dedicated actuators only. When other actuators are used, the interlock switch may be damaged.
- For correct operation, install the interlock switch on a flat surface and provide sufficient strength to the surface so that it is not disfigured. Do not insert any object between the interlock switch and installation surface.
- Do not cut the actuator. modification of the actuator may cause damage.
- The locking strength is rated at 500N. Do not apply a load higher than the rated value. When a higher load is expected, provide an additional system consisting of another interlock switch without lock (such as the HS6B/HS7A interlock switch) or a sensor to detect door opening and stop the machine.
- Regardless of door types, do not use the interlock switch as a door lock. Install a separate lock using a latch or other measures.
- While the solenoid is energized, the switch temperature rises approximately 35°C above the ambient temperature (to approximately 85°C while the ambient temperature is 50°C). Do not touch to prevent burns. If cables come into contact with the switch, use heat-resistant cables.
- Solenoid has polarity. Be sure of correct polarity when wiring, otherwise solenoid will be damaged. Do not apply voltage over the rated voltage, otherwise the solenoid will be burnt.
- Bouncing will occur on the lock monitor contact during locking and unlocking (reference value: 20 ms).
- Although the HS9Z-A61/A62/A62S actuators alleviate shock when the actuator enters a slot in the interlock switch, make sure that excessive shock is not applied. If the rubber bushings become deformed or cracked, replace with new ones.

Minimum Radius of Hinged Door

- When using the interlock switch on hinged doors, refer to the minimum radius of doors shown below. When using on doors with small minimum radius, use the angle adjustable actuator (HS9Z-A65 and HS9Z-A66).

Note: Because deviation or dislocation of hinged doors may occur in actual applications, make sure of the correct operation before installation.

When Using the HS9Z-A62/A62S Right-angle Actuator

- When the door hinge is on the extension line of the interlock switch surface:

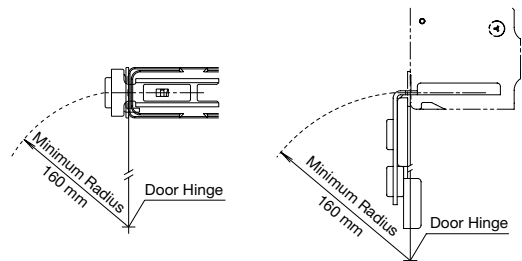

- When the door hinge is on the extension line of the actuator mounting surface:

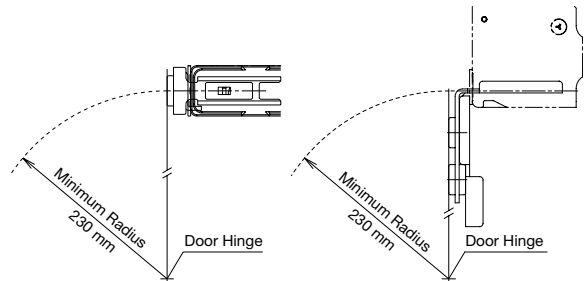

HS6E Subminiature Interlock Switches with Solenoid

When using the HS9Z-A65/HS9Z-A66 Angle Adjustable Actuator

- When the door hinge is on the extension line of the interlock switch surface

Horizontal Adjustment

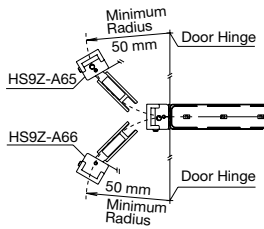

Vertical Adjustment

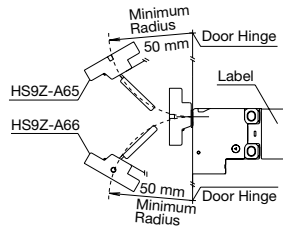

- When the door hinge is on the extension line of the actuator mounting surface

Horizontal Adjustment

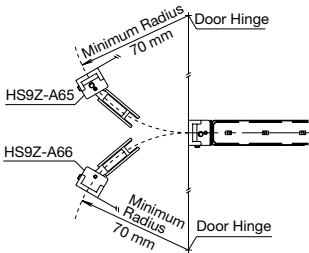

Vertical Adjustment

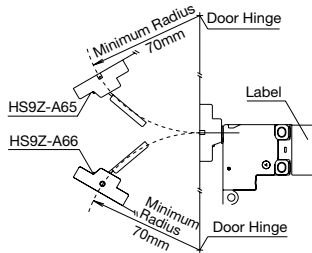

Actuator Angle Adjustment for the HS9Z-A65/HS9Z-A66

- Using the angle adjustment screw, the actuator angle can be adjusted (see figures on page 17).
Adjustable angle: 0 to 20°
- The larger the adjusted angle of the actuator, the smaller the applicable radius of the door opening.
- After installing the actuator, open the door. Then adjust the actuator so that its edge can enter properly into the actuator entry slot of the interlock switch.
- After adjusting the actuator angle, apply Loctite to the adjustment screw so that the screw will not become loose.

Mounting Examples

Mount the interlock switch on a fixated machine or guard, and mount the actuator on the hinged door. Do not mount both interlock switch and actuator on hinged doors, otherwise malfunction will occur.

Application on Sliding Doors

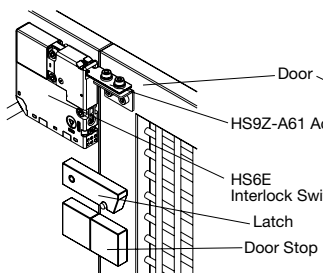

Application on Hinged Doors

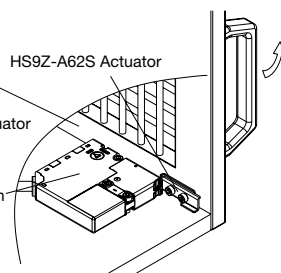

Note: When mounting an actuator, make sure that the actuator enters the slot in the correct direction, as shown on the right.

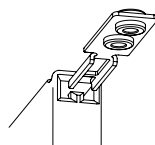

For Manual Unlocking

Spring lock

The HS6E allows manual unlocking of the actuator to pre-check proper door operation before wiring or turning power on, as well as for emergency use such as a power failure.

Solenoid lock

The HS6E can be unlocked manually in emergency.

When using the manual unlock key

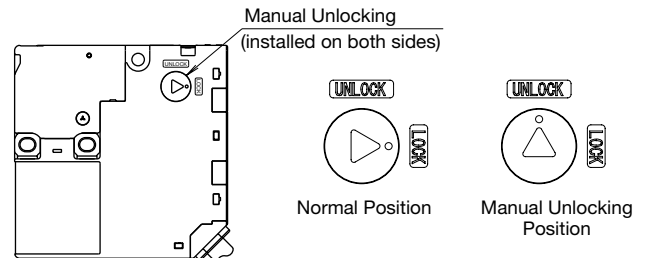

- When locking or unlocking the interlock switch manually, turn the key fully using the manual unlock key supplied with the switch.
- Using the interlock switch with the key not fully turned (less than 90°) may cause damage to the interlock switch or operation failures (when manually unlocked, the switch will keep the main circuit disconnected and the door unlocked).
- Do not apply excessive force (0.45 N·m or more) to the manual unlock part, otherwise the manual unlock part will become damaged.
- Do not leave the manual unlock key attached to the switch during operation. This is dangerous because the switch can always be unlocked while the machine is in operation.



Manual Unlock Key
(supplied with the interlock switch)

When unlocking pushing the plate inside the interlock switch

- Remove the screw at the side of the interlock switch (the same side where actuator is inserted) and insert a small screwdriver.
- Push the plate inside the interlock switch toward the LED indicator using the screwdriver until the actuator is unlocked.
- Tighten the screw to a proper torque (0.3 to 0.5 N·m). Do not tighten with excessive force, otherwise the interlock switch will be damaged. Be sure to reinstall the screw, otherwise the waterproof capability will be lost.

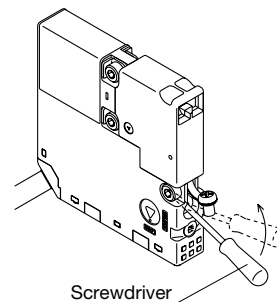

Caution

Before manually unlocking the interlock switch, make sure that the machine has come to a complete stop. Manual unlocking during operation may unlock the interlock switch before the machine stops, and the function of the interlock switch with solenoid is lost. While the solenoid is energized, do not unlock the switch manually (solenoid lock).

HS6E Subminiature Interlock Switches with Solenoid

Recommended Tightening Torque of Mounting Screws

- Interlock switch: 1.0 to 1.5 N·m (three M4 screws)
- Actuators: 1.0 to 1.5 N·m (two M4 screws)
- The above recommended tightening torques of the mounting screws are the values with hex socket head bolts. When other screws are used and tightened to a smaller torque, make sure that the screws do not become loose after mounting.
- Mounting bolts are not supplied with the interlock and must be supplied by the user.
- To avoid unauthorized or unintended removal of the interlock switch and the actuator, it is recommended that the interlock switch and the actuator are installed in an unremovable manner, for example using special screws, rivets, or welding the screws.
- When installing the HS9Z-A62S actuator, use the mounting plate (supplied with the actuator) on the hinged door, and secure the actuator tightly using two M4 screws.
- The mounting plate has orientation.
- Do not lose the mounting plate.

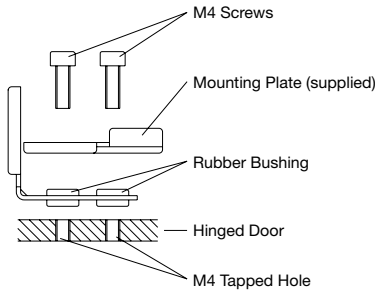

Cables

- Do not fasten or loosen the gland at the bottom of the interlock switch.
- When bending the cable during wiring, make sure that the cable radius is kept at 30 mm minimum.
- When wiring, make sure that water or oil does not enter from the end of the cable.
- Do not open the lid of the interlock switch. Otherwise the interlock switch will be damaged.
- The solenoid has polarity. Make sure of the correct polarity when wiring.

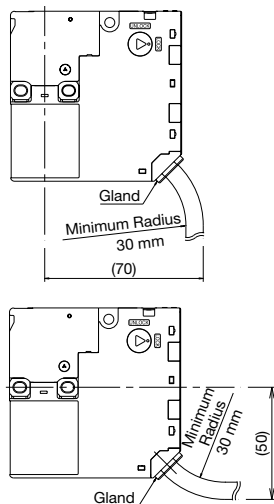

Wire Identification

- Wires can be identified by the color and or a white line printed on the wire.

No.	Insulation Color	No.	Insulation Color
1	Blue/White	7	White
2	Gray	8	Black
3	Pink	9	Pink/White
4	Orange	10	Brown/White
5	Orange/White	11	Brown
6	Gray/White	12	Blue

Note: Wires of gray or gray/white are not used and should not be connected.

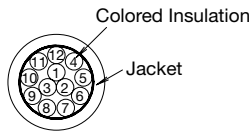

Terminal Number Identification

- When wiring, identify the terminal number of each contact by the color of insulation.
- The following table shows the identification of terminal numbers.
- When wiring, cut unused wires at the end of the jacket to avoid incorrect wiring.

Model	Contact Arrangement	
	Door Monitor	Lock Monitor
HS6E-L		
	Main circuit: Blue (11) → 12	41 → 42 Blue/White
	Monitor circuit: Brown (21) → 22 Brown/White	Pink 53 → 54 Pink/White
	Monitor circuit: Orange (31) → 32 Orange/White	
HS6E-M	Main circuit: Blue (11) → 12	41 → 42 Blue/White
	Monitor circuit: Brown (21) → 22 Brown/White	Pink 51 → 52 Pink/White
	Monitor circuit: Orange (31) → 32 Orange/White	
HS6E-N	Main circuit: Blue (11) → 12	41 → 42 Blue/White
	Monitor circuit: Brown (21) → 22 Brown/White	Pink 53 → 54 Pink/White
	Monitor circuit: Orange (33) → 34 Orange/White	
HS6E-P	Main circuit: Blue (11) → 12	41 → 42 Blue/White
	Monitor circuit: Brown (21) → 22 Brown/White	Pink 51 → 52 Pink/White
	Monitor circuit: Orange (33) → 34 Orange/White	
HS6E-VL	Monitor circuit: Blue (11) → 12 Blue/White	Gray 41 → 42 Gray/White
	Monitor circuit: Brown (21) → 22 Brown/White	
	Monitor circuit: Orange (31) → 32 Orange/White	Pink 53 → 54 Pink/White
	Monitor circuit:	
HS6E-VM	Monitor circuit: Blue (11) → 12 Blue/White	Gray 41 → 42 Gray/White
	Monitor circuit: Brown (21) → 22 Brown/White	
	Monitor circuit: Orange (31) → 32 Orange/White	Pink 51 → 52 Pink/White
	Monitor circuit:	
HS6E-VN	Monitor circuit: Blue (11) → 12 Blue/White	Gray 41 → 42 Gray/White
	Monitor circuit: Brown (21) → 22 Brown/White	
	Monitor circuit: Orange (33) → 34 Orange/White	Pink 53 → 54 Pink/White
	Monitor circuit:	
HS6E-VP	Monitor circuit: Blue (11) → 12 Blue/White	Gray 41 → 42 Gray/White
	Monitor circuit: Brown (21) → 22 Brown/White	
	Monitor circuit: Orange (33) → 34 Orange/White	Pink 51 → 52 Pink/White
	Monitor circuit:	

Note: The contact arrangements show the contact status when the actuator is inserted and locked.