

N-Channel Trench MOSFET

Description

The G33N03D3 uses advanced trench technology to provide excellent $R_{DS(ON)}$, low gate charge. It can be used in a wide variety of applications.

General Features

- V_{DS} 30V
- I_D (at $V_{GS} = 10V$) 30A
- $R_{DS(ON)}$ (at $V_{GS} = 10V$) < 13m Ω
- $R_{DS(ON)}$ (at $V_{GS} = 4.5V$) < 18m Ω
- 100% Avalanche Tested
- RoHS Compliant

Application

- Power switch
- DC/DC converters

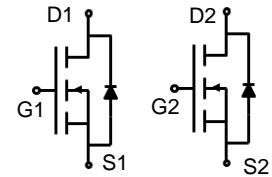

Schematic diagram

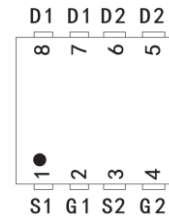

Marking and pin assignment

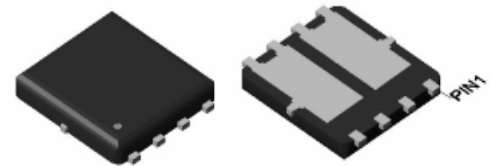

DFN3.3X3.3-8L

Device	Package	Marking	Packaging
G33N03D3	DFN3.3X3.3-8L	G33N03	5000pcs/Reel

Absolute Maximum Ratings $T_C = 25^\circ C$, unless otherwise noted

Parameter	Symbol	Value	Unit
Drain-Source Voltage	V_{DS}	30	V
Continuous Drain Current	I_D	30	A
Pulsed Drain Current (note1)	I_{DM}	85	A
Gate-Source Voltage	V_{GS}	± 20	V
Power Dissipation	P_D	18.5	W
Operating Junction and Storage Temperature Range	T_J, T_{stg}	-55 To 150	$^\circ C$

Thermal Resistance

Parameter	Symbol	Value	Unit
Thermal Resistance, Junction-to-Case	R_{thJC}	6.7	$^\circ C/W$

Specifications $T_J = 25^\circ\text{C}$, unless otherwise noted						
Parameter	Symbol	Test Conditions	Value			Unit
			Min.	Typ.	Max.	
Static Parameters						
Drain-Source Breakdown Voltage	$V_{(BR)DSS}$	$V_{GS} = 0V, I_D = 250\mu A$	30	--	--	V
Zero Gate Voltage Drain Current	I_{DSS}	$V_{DS} = 30V, V_{GS} = 0V$	--	--	1	μA
Gate-Source Leakage	I_{GSS}	$V_{GS} = \pm 20V$	--	--	± 100	nA
Gate-Source Threshold Voltage	$V_{GS(th)}$	$V_{DS} = V_{GS}, I_D = 250\mu A$	1	1.5	2.5	V
Drain-Source On-Resistance	$R_{DS(on)}$	$V_{GS} = 10V, I_D = 16A$	--	9	13	m Ω
		$V_{GS} = 4.5V, I_D = 14A$	--	14.5	18	
Dynamic Parameters						
Input Capacitance	C_{iss}	$V_{GS} = 0V,$ $V_{DS} = 15V,$ $f = 1.0MHz$	--	1530	--	pF
Output Capacitance	C_{oss}		--	250	--	
Reverse Transfer Capacitance	C_{rss}		--	200	--	
Total Gate Charge	Q_g	$V_{DD} = 15V,$ $I_D = 9A,$ $V_{GS} = 10V$	--	15	--	nC
Gate-Source Charge	Q_{gs}		--	3	--	
Gate-Drain Charge	Q_{gd}		--	4.5	--	
Turn-on Delay Time	$t_{d(on)}$	$V_{DD} = 15V,$ $I_D = 10A,$ $R_G = 1.8\Omega$	--	10	--	ns
Turn-on Rise Time	t_r		--	8	--	
Turn-off Delay Time	$t_{d(off)}$		--	30	--	
Turn-off Fall Time	t_f		--	5	--	
Drain-Source Body Diode Characteristics						
Continuous Body Diode Current	I_S	$T_C = 25^\circ\text{C}$	--	--	30	A
Body Diode Voltage	V_{SD}	$T_J = 25^\circ\text{C}, I_{SD} = 16A, V_{GS} = 0V$	--	--	1.2	V
Reverse Recovery Time	trr	$T_J = 25^\circ\text{C}, IF = 10A$ $di/dt = 100A/\mu s$	--	22	35	ns
Reverse Recovery Charge	Qrr		--	12	20	nc

Notes

1. Repetitive Rating: Pulse width limited by maximum junction temperature
2. Identical low side and high side switch with identical R_G

Gate Charge Test Circuit

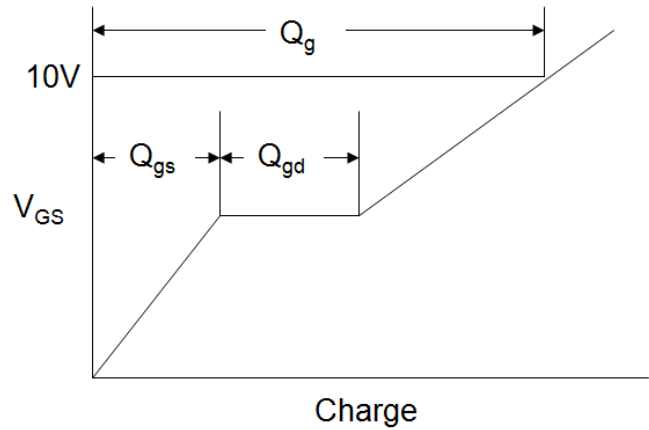

Switch Time Test Circuit



EAS Test Circuit

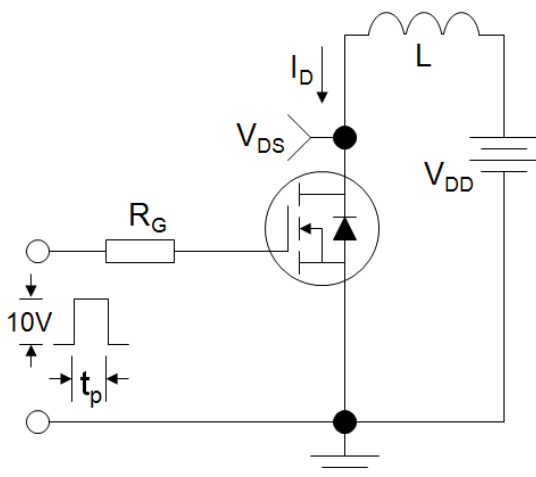

Typical Characteristics $T_J = 25^\circ\text{C}$, unless otherwise noted

Figure 1. Output Characteristics

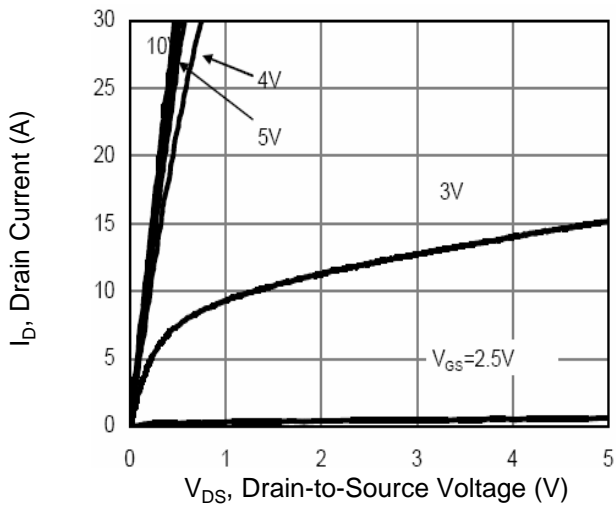

Figure 2. Transfer Characteristics

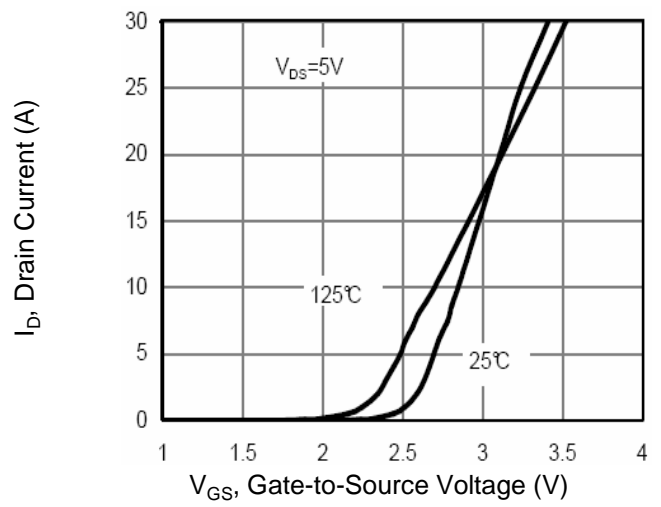

Figure 3. Gate Charge

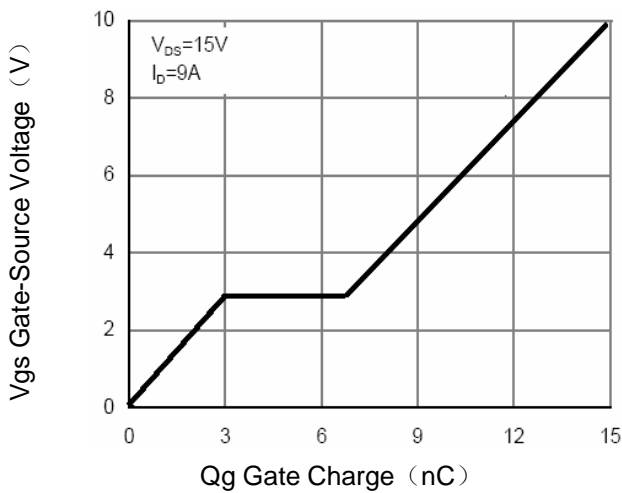

Figure 4. Drain Source On Resistance

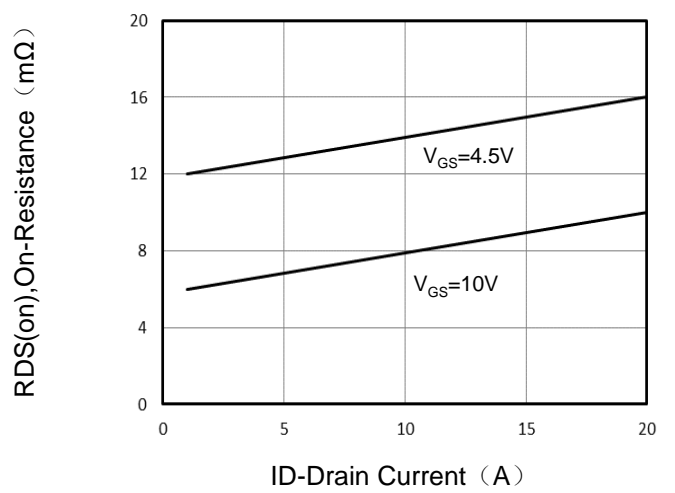

Figure 5. Capacitance

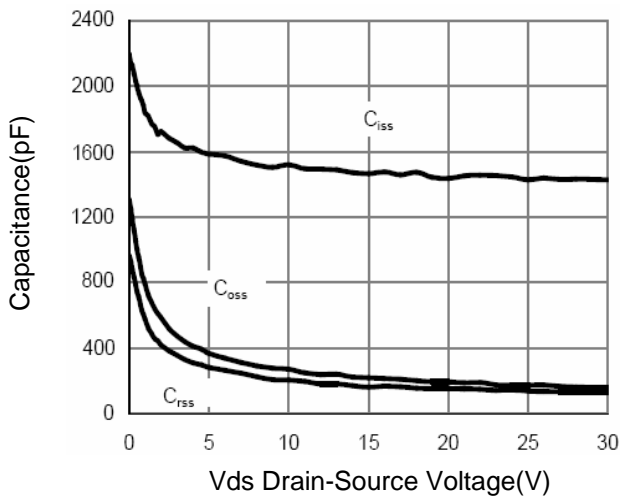
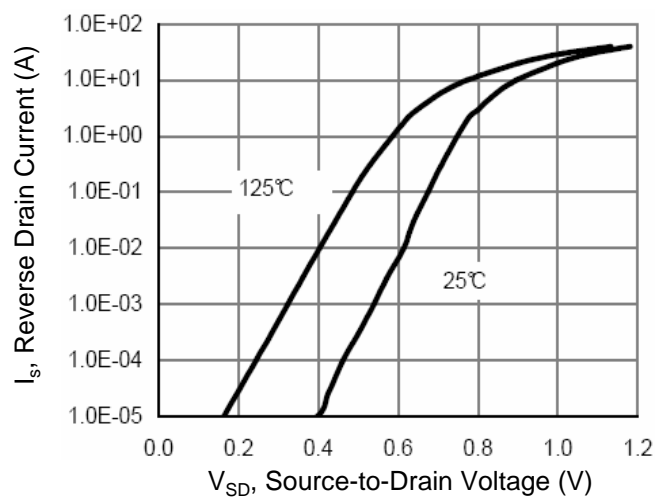

Figure 6. Source-Drain Diode Forward



Typical Characteristics $T_J = 25^\circ\text{C}$, unless otherwise noted

Figure 7. Drain-Source On-Resistance

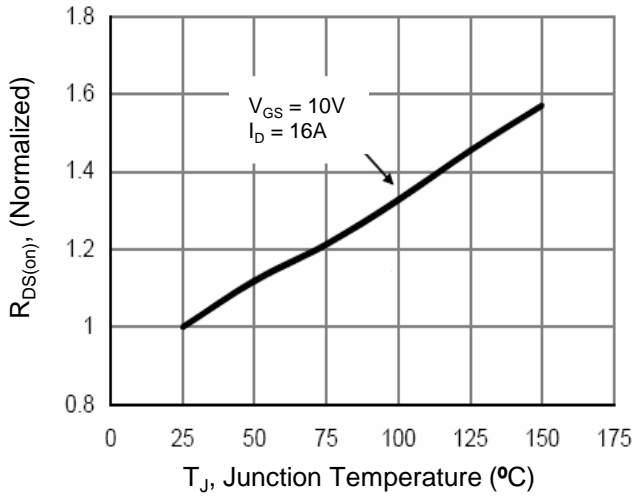

Figure 8. Safe Operation Area

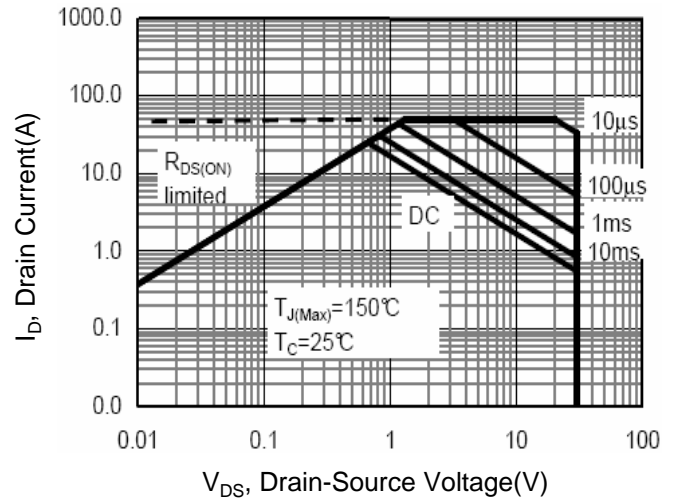
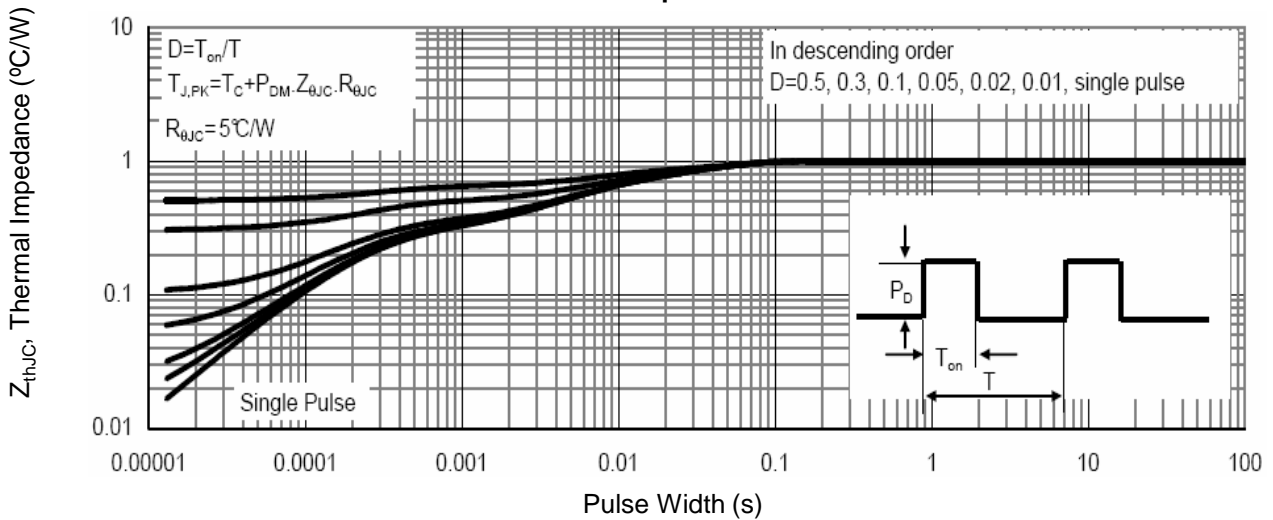
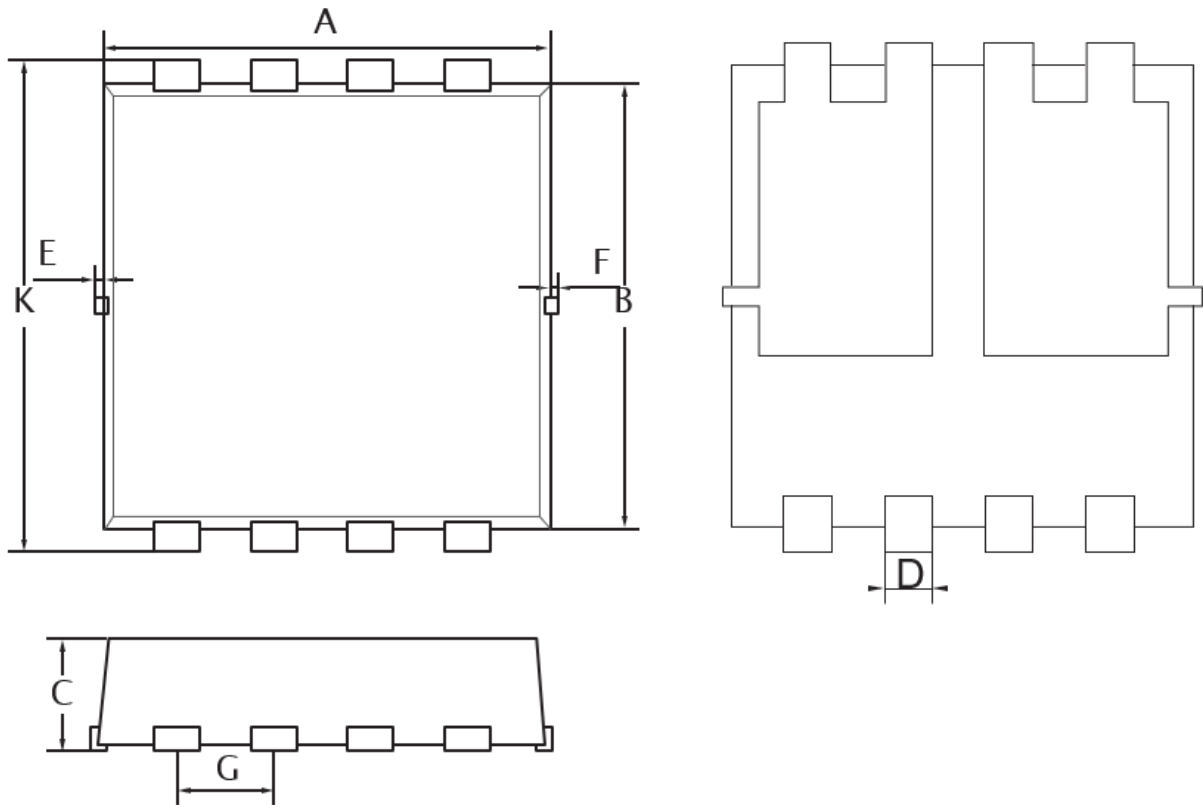

Figure 9. Normalized Maximum Transient Thermal Impedance



DFN3.3*3.3 Package Information



DFN3.3X.3.3-8L.		
Dim	Mim	Max
A	2.90	3.10
B	2.90	3.10
C	0.65	0.85
D	0.20	0.40
E	0.00	0.10
F	0.00	0.10
G	0.55	0.75
K	3.15	3.15
All Dimensions in mm		