



SPECIFICATIONS

Model	Rated Torque	Damping Direction	Max Rotation Speed	Max Cycle Rate
FRN-P2-L102-G1	0.10±0.02Nm (1.0±0.2kgfcm)	Counter-clockwise	50 RPM	10 cycles/min.

Operating Temperature	Weight	Body & Cap Material	Rotating Shaft Material	Gear Material	Oil Type
0 ~ 50°C	64g	Polybutylene terephthalate (PBT)	Metal (SUS)	Polyacetal (POM)	Silicone Oil

Note 1) Rated torque measured at a rotation speed of 20rpm at 23°C

Note 2) Gear model number has G1 at the end

Note 3) Torque can be customized by changing the oil viscosity

■ There are dampers that generate torque in both directions and one-way torque in the clockwise direction or counter clockwise direction when the rotating axle is viewed from the top

GEAR SPECIFICATIONS

Model	Type	Tooth Profile	Module	Pressure Angle	Number of Teeth	Pitch Circle Diameter	Addendum Modification Coefficient
G1	Standard Spur Gear	Involute	1.5	20°	28	∅42	—

DAMPING CHARACTERISTICS

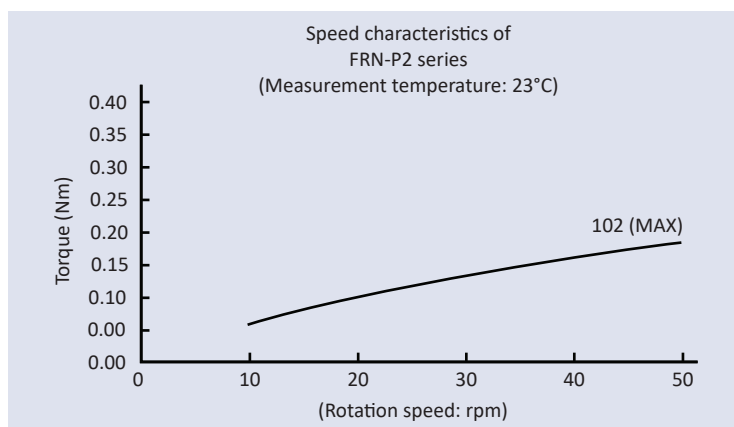

■ **Speed characteristics:** A rotary damper's torque varies according to the rotation speed. In general, as shown in the graph above, the torque increases as the rotation speed increases, and the torque decreases as the rotation speed decreases. In addition, please note that the starting torque slightly differs from the rated torque.

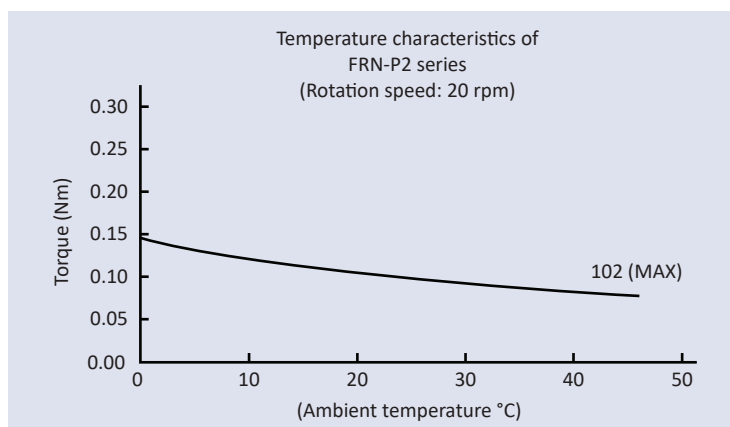

■ **Temperature characteristics:** A rotary damper's torque varies according to the ambient temperature. In addition, as shown in the graph above, the torque decreases as the ambient temperature increases, and the torque increases as the ambient temperature decreases. This is because the viscosity of the silicone oil inside the damper varies according to the temperature. When the temperature returns to normal, the torque will return to normal as well.

HOW TO ADJUST TORQUE

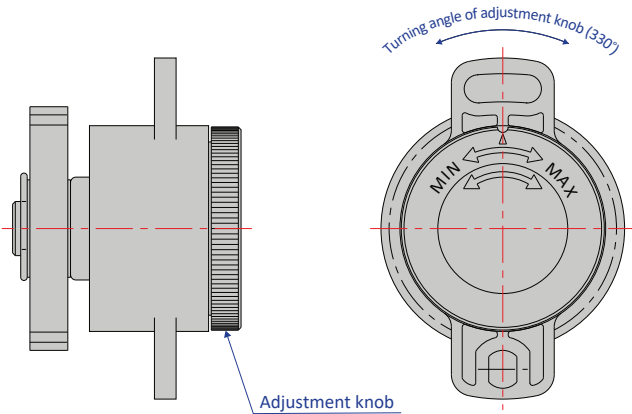

Turn the adjustment knob clockwise to increase damper torque and counterclockwise to decrease it.

RANGE OF TORQUE ADJUSTMENT

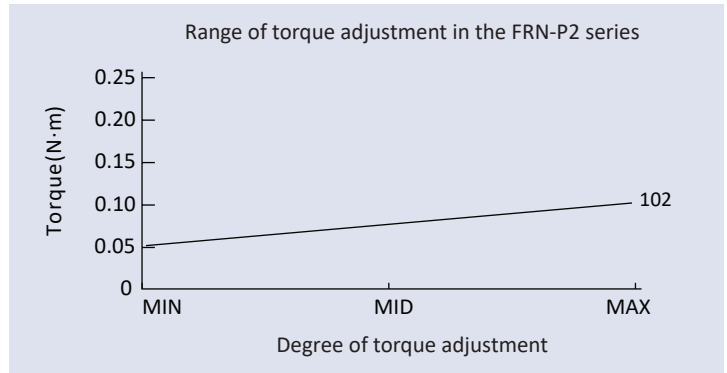

EXAMPLE OF USING A DAMPER

Application of the FRN-P2 Series

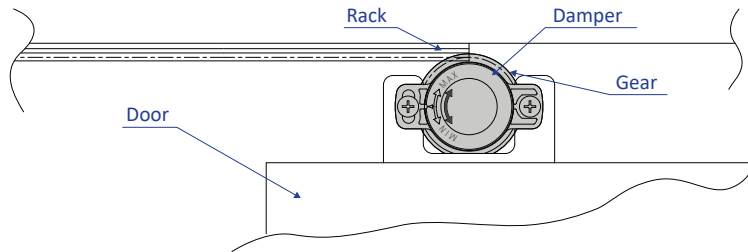

OPTION RACK

G1 Rack : ROP-020P2-1

Applicable Models: FRN-P2

*Can be used with
G1 option ONLY

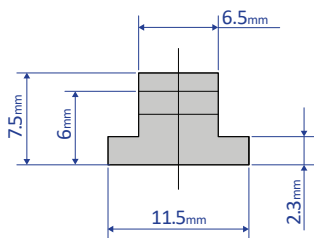

Rack specifications : $m=1.5$ $Z=85$

Pressure angle 20° (full depth tooth)

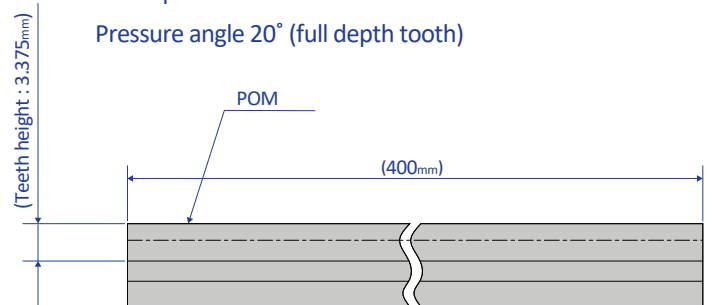

There is no provision for option racks complying with the gear specification G2 (shifted spur gear) of FRN-P2