

IN THE CONSTANT PURPOSE OF IMPROVING ITS PRODUCTS, Amphenol Socapex RESERVES THE RIGHT TO MODIFY ANY DIMENSION OR CHARACTERISTICS.
FM.NPD.0036.THYEZ.PUNE rev C

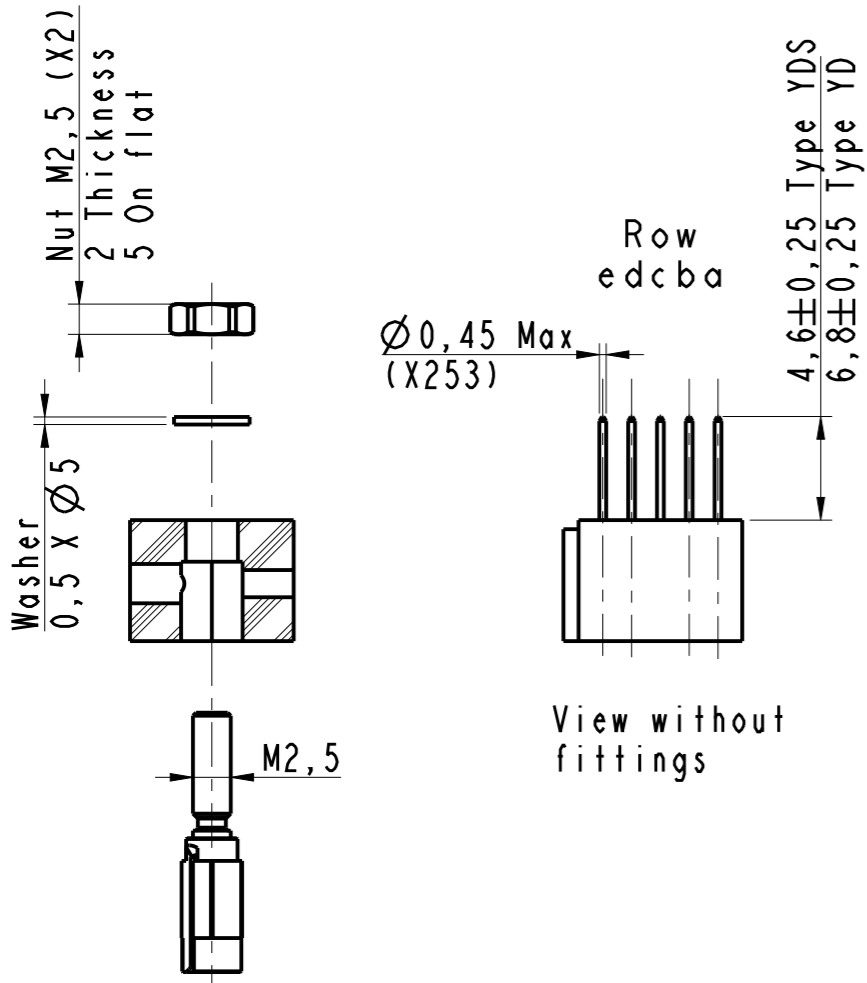

Section A-A

- Notes:
- Part: HDAS E 253 YDX-X0X XXX
 - External dimension of the receptacle insulator with 253 signal contacts type YDX
 - Connector delivered with fittings not assembled, coupling torque : 0,25 Nm
 - Standard 00X : Nickel plated over brass fittings.
Deviation 10X : Passivated stainless steel fittings.

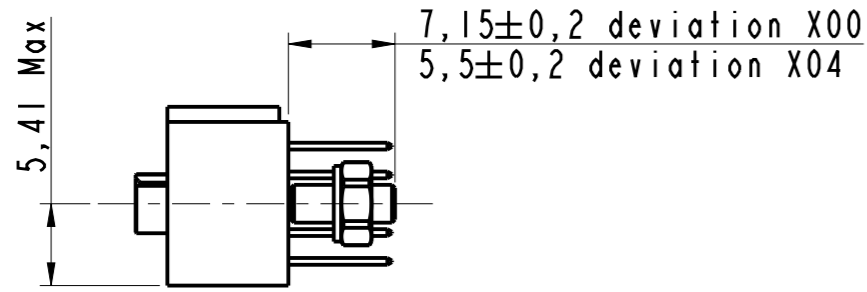
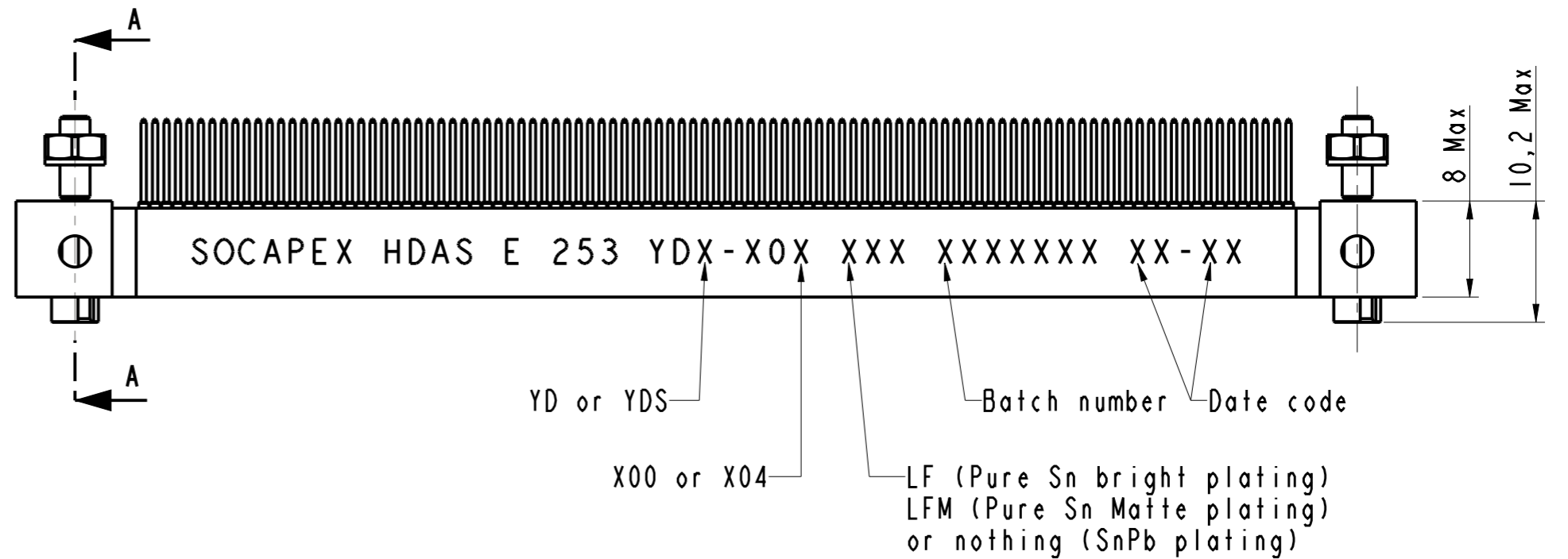
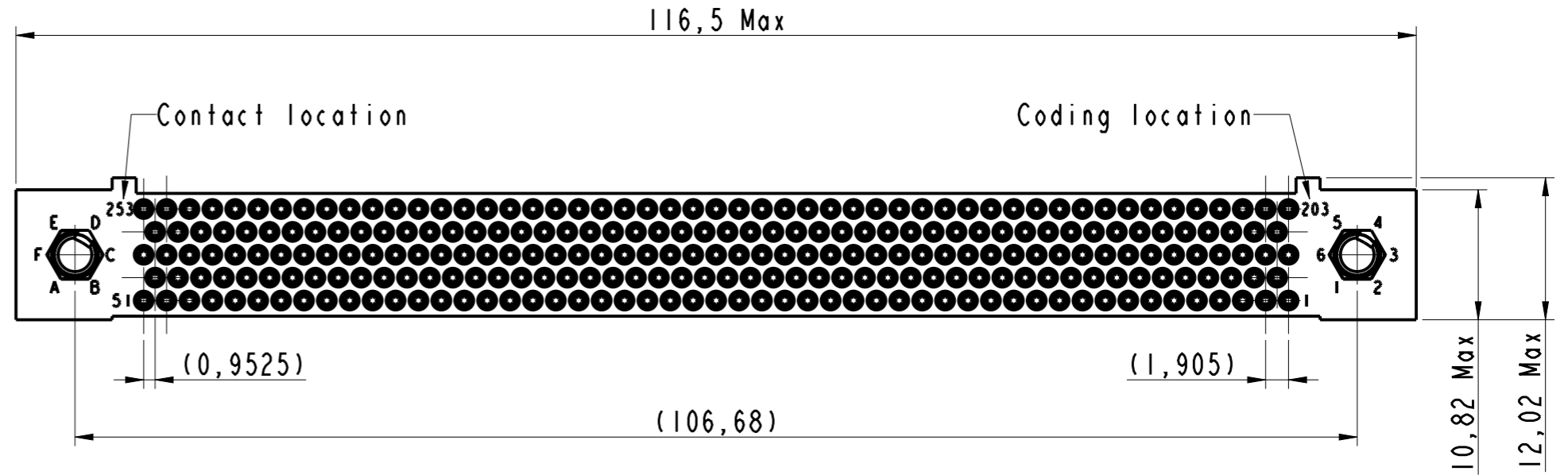

HDAS E 253 YDX-X0X XXX

DRAWN BY : Gimenes		UPDATED BY : S Satpute		LAST APPROVED BY : T Carrier	
ALL DIMENSIONS ARE IN MM	AMPHENOL SOCAPEX			ORIGINAL DRAWING DATE : 27/04/2006	CONFIGURATION DATA ARE AVAILABLE IN PDM
				REV : F	PAGE : 1/2
SCALE : 2	B.P. 29 74311 THYEZ CEDEX			169-PLC-496-00	

PCB Layout Face A

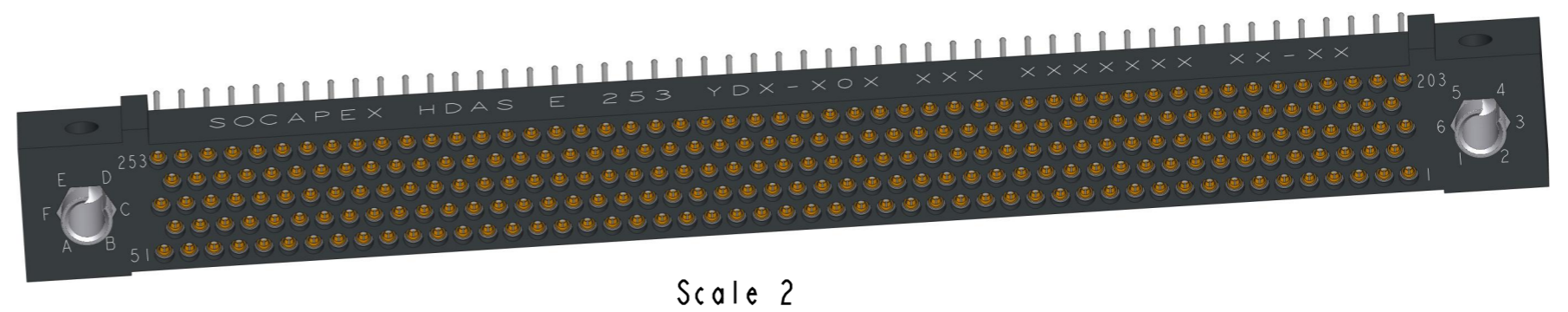
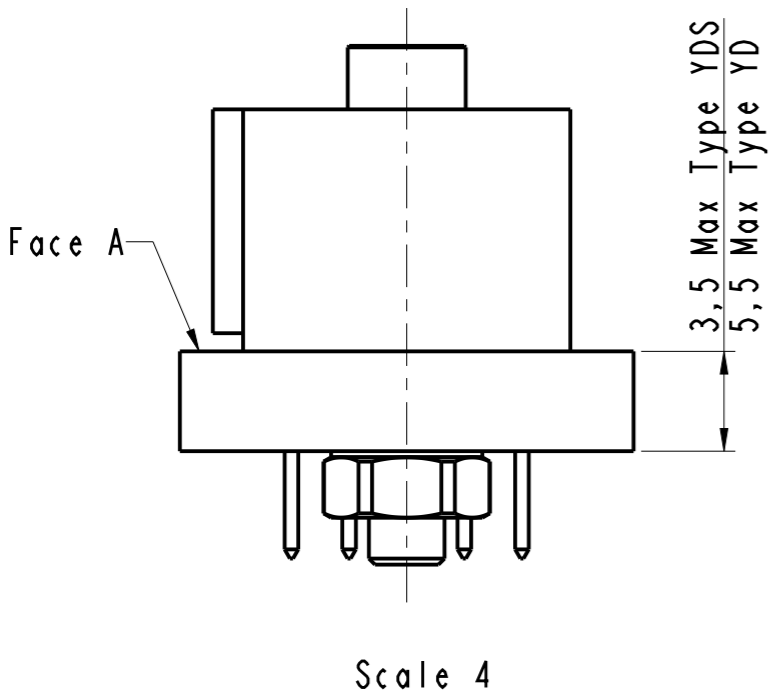
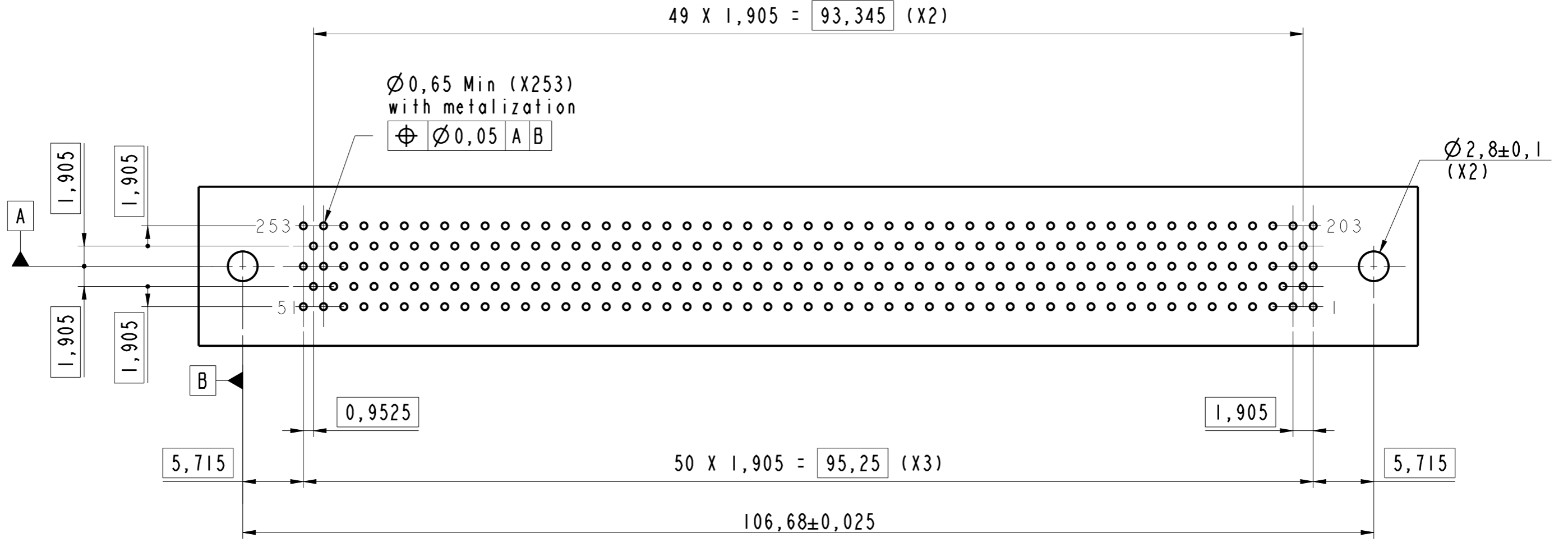

HDAS E 253 YDX-X0X XXX

DRAWN BY : Gimenes		UPDATED BY : S Satpute		LAST APPROVED BY : T Carrier	
ALL DIMENSIONS ARE IN MM		AMPHENOL SOCAPEX		ORIGINAL DRAWING DATE : 27/04/2006	CONFIGURATION DATA ARE AVAILABLE IN PDM
SCALE : 2,5				REV : F	PAGE : 2/2
		B.P. 29 74311 THYEZ CEDEX		169-PLC-496-00	

IN THE CONSTANT PURPOSE OF IMPROVING ITS PRODUCTS, Amphenol Socapex reserves the right to modify any dimension or characteristics. FM.NPD.0036.THYEZ.PUNE rev C