

Data sheet | Item number: 2110-5201

2-conductor through terminal block; with lever and push-button; 10 mm²; with test port; side and center marking; for DIN-rail 35 x 15 and 35 x 7.5; Push-in CAGE CLAMP®; 10,00 mm²; gray

www.wago.com/2110-5201

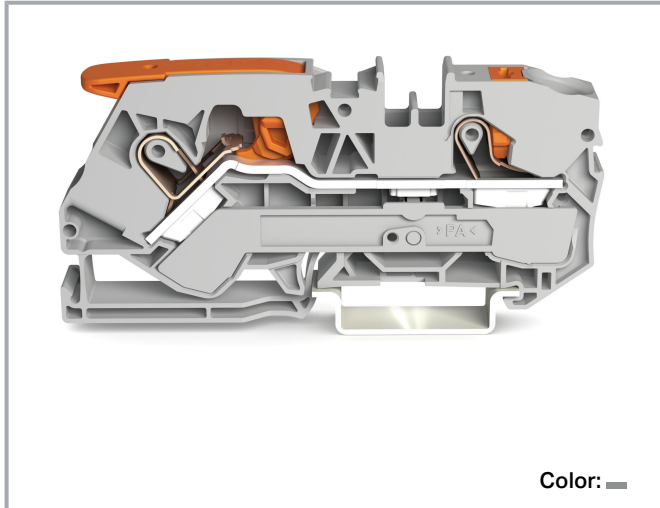

Color: —

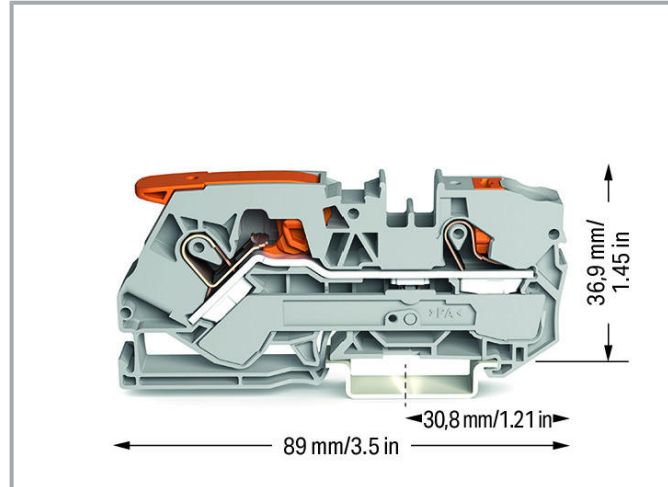

Data

Electrical data

Approvals per	UL 1059
Rated voltage UL (Use Group B)	600 V
Rated current UL (Use Group B)	65 A
Rated voltage UL (Use Group C)	600 V
Rated current UL (Use Group C)	65 A
Approvals per	C22.2 No 158
Rated voltage CSA (Use Group B)	600 V
Rated current CSA (Use Group B)	65 A
Rated voltage CSA (Use Group C)	600 V
Rated current CSA (Use Group C)	65 A
Ratings per	IEC/EN 60947-7-1
Nominal voltage (III/3)	800 V
Rated surge voltage (III/3)	8 kV
Rated current	57 A
Rated current 2	74 A
Legend (ratings)	(III / 3) ≙ Overtoltage category III / Pollution degree 3
Ratings per	ATEX: PTB 19 ATEX 1017 U / IECEx: PTB 19.0047U (Ex eb IIC Gb)

Subject to changes. Please also observe the further product documentation!

WAGO Kontakttechnik GmbH & Co. KG
Hansastr. 27
32423 Minden
Phone: +49571 887-0 | Fax: +49571 887-169
Email: info.de@wago.com | Web: www.wago.com

Do you have any questions about our products?
We are always happy to take your call at +49 (571) 887-44222.



Rated voltage EN (Ex e II)	550 V
Rated current (Ex e II)	57 A
Rated current (Ex e II) with jumper	50 A

Connection data

Total number of connection points	2
Total number of potentials	1
Number of levels	1
Number of jumper slots	2
Connection technology	Push-in CAGE CLAMP®
Actuation type	Push-in Operating tool
Connectable conductor materials	Copper
Nominal cross-section	10 mm ²
Solid conductor	0.5 ... 16 mm ² / 20 ... 6 AWG
Solid conductor; push-in termination	4 ... 16 mm ² / 14 ... 6 AWG
Fine-stranded conductor	0.5 ... 16 mm ² / 20 ... 6 AWG
Fine-stranded conductor; with insulated ferrule	0.5 ... 10 mm ² / 20 ... 8 AWG
Fine-stranded conductor; with ferrule; push-in termination	4 ... 10 mm ² / 12 ... 8 AWG
Note (conductor cross-section)	Depending on the conductor characteristic, a conductor with a smaller cross-section can also be inserted via push-in termination.
Strip length	17 ... 19 mm / 0.67 ... 0.75 inch
Wiring direction	Front-entry wiring

Physical data

Width	10 mm / 0.394 inch
Height	89 mm / 3.504 inch
Depth from upper edge of DIN-rail	36.9 mm / 1.453 inch

Mechanical data

Design	horizontal type
Mounting type	DIN-35 rail
Marking level	Center/side marking

Material data

Color	gray
Insulation material	Polyamide (PA66)

Subject to changes. Please also observe the further product documentation!



Flammability class per UL94	V0
Fire load	0.029 MJ
Weight	25.7 g

Commercial data



PU (SPU)	25 Stück
Packaging type	box
Country of origin	PL
GTIN	4055143865203
Customs tariff number	85369010000

Approvals / Certificates

Ex-Approvals

Logo	Approval	Additional Approval Text	Certificate name
	ATEX Physikalisch Technische Bundesanstalt	EN 60079-0	PTB 19 ATEX 1017 U (II 2 G Ex eb IIC Gb bzw. I M 2 Ex eb I Mb)
	CCCEX CQST/CNEx	CNCA-C23-01	2020312313000165
	IECEX Physikalisch Technische Bundesanstalt	IEC 60079	IECEX PTB 19.0047 U (Ex eb IIC Gb or Ex eb I Mb)



Country specific Approvals

Logo	Approval	Additional Approval Text	Certificate name
	CCA DEKRA Certification B.V.	EN 60947	NTR NL- 7757
	KEMA/KEUR DEKRA Certification B.V.	EN 60947	71- 109053

UL-Approvals



Certificate

Subject to changes. Please also observe the further product documentation!

Logo	Approval	Additional Approval Text	name
	cURus Underwriters Laboratories Inc.	UL 60079	E185892
	UL Underwriters Laboratories Inc.	UL 1059	E45172

Required accessories

End plate





End plate		
	Item no.: 2110-1291 End and intermediate plate; 1 mm thick; gray	www.wago.com/2110-1291
	Item no.: 2110-1292 End and intermediate plate; 1 mm thick; orange	www.wago.com/2110-1292

Optional accessories

Cover

Cover		
	Item no.: 2010-100 Finger guard; touchproof cover protects unused conductor entries; yellow	www.wago.com/2010-100

Ferrule

Ferrule		
	Item no.: 216-284 Ferrule; Sleeve for 1.5 mm ² / AWG 16; insulated; electro-tin plated; electrolytic copper; gastight crimped; acc. to DIN 46228, Part 4/09.90; black	www.wago.com/216-284
	Item no.: 216-286 Ferrule; Sleeve for 2.5 mm ² / AWG 14; insulated; electro-tin plated; electrolytic copper; gastight crimped; acc. to DIN 46228, Part 4/09.90; blue	www.wago.com/216-286
	Item no.: 216-287 Ferrule; Sleeve for 4 mm ² / AWG 12; insulated; electro-tin plated; electrolytic copper; gastight crimped; acc. to DIN 46228, Part 4/09.90; gray	www.wago.com/216-287
	Item no.: 216-288 Ferrule; Sleeve for 6 mm ² / AWG 10; insulated; electro-tin plated; electrolytic copper; gastight crimped; acc. to DIN 46228, Part 4/09.90; yellow	www.wago.com/216-288
	Item no.: 216-289	

Subject to changes. Please also observe the further product documentation!



Ferrule; Sleeve for 10 mm² / AWG 8; insulated; electro-tin plated; electrolytic copper; gastight crimped; www.wago.com/216-289
acc. to DIN 46228, Part 4/09.90; red

Carrier rail

Mounting accessories



Item no.: 210-197

Steel carrier rail; 35 x 15 mm; 1.5 mm thick; 2 m long; slotted; similar to EN 60715; silver-colored

www.wago.com/210-197



Item no.: 210-198

Copper carrier rail; 35 x 15 mm; 2.3 mm thick; 2 m long; unslotted; according to EN 60715; copper-colored

www.wago.com/210-198

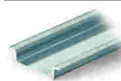

Item no.: 210-113

Steel carrier rail; 35 x 7.5 mm; 1 mm thick; 2 m long; unslotted; according to EN 60715; silver-colored

www.wago.com/210-113



Item no.: 210-118

Steel carrier rail; 35 x 15 mm; 2.3 mm thick; 2 m long; unslotted; according to EN 60715; silver-colored

www.wago.com/210-118



Item no.: 210-114

Steel carrier rail; 35 x 15 mm; 1.5 mm thick; 2 m long; unslotted; similar to EN 60715; silver-colored

www.wago.com/210-114

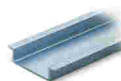

Item no.: 210-196

Aluminum carrier rail; 35 x 8.2 mm; 1.6 mm thick; 2 m long; unslotted; similar to EN 60715; silver-colored

www.wago.com/210-196

Marking accessories

Marking strip



Item no.: 2009-110

Marking strips; for Smart Printer; on reel; not stretchable; plain; snap-on type; white

www.wago.com/2009-110

Marker carrier



Item no.: 2009-198

Adaptor; gray

www.wago.com/2009-198

Marker



Item no.: 2009-115/000-002

WMB-Inline; for Smart Printer; 1500 pieces on roll; stretchable 5 - 5.2 mm; plain; snap-on type; yellow

www.wago.com/2009-115/000-002



Item no.: 2009-115/000-007

WMB-Inline; for Smart Printer; 1500 pieces on roll; stretchable 5 - 5.2 mm; plain; snap-on type; gray

www.wago.com/2009-115/000-007



Item no.: 2009-115/000-017

WMB-Inline; for Smart Printer; 1500 pieces on roll; stretchable 5 - 5.2 mm; plain; snap-on type; light green

www.wago.com/2009-115/000-017



Item no.: 2009-115/000-023

WMB-Inline; for Smart Printer; 1500 pieces on roll; stretchable 5 - 5.2 mm; plain; snap-on type; green

www.wago.com/2009-115/000-023

Subject to changes. Please also observe the further product documentation!

WAGO Kontakttechnik GmbH & Co. KG

Hansastr. 27

32423 Minden

Phone: +49571 887-0 | Fax: +49571 887-169

Email: info.de@wago.com | Web: www.wago.com

Do you have any questions about our products?

We are always happy to take your call at +49 (571) 887-44222.



Item no.: 2009-115/000-024

WMB-Inline; for Smart Printer; 1500 pieces on roll; stretchable 5 - 5.2 mm; plain; snap-on type; violet

www.wago.com/2009-115/000-024

Item no.: 2009-145/000-006

Mini-WSB Inline; for Smart Printer; 1700 pieces on roll; stretchable 5 - 5.2 mm; plain; snap-on type; blue

www.wago.com/2009-145/000-006

Item no.: 2009-145

Mini-WSB Inline; for Smart Printer; 1700 pieces on roll; stretchable 5 - 5.2 mm; plain; snap-on type; white

www.wago.com/2009-145

Item no.: 2009-145/000-002

Mini-WSB Inline; for Smart Printer; 1700 pieces on roll; stretchable 5 - 5.2 mm; plain; snap-on type; yellow

www.wago.com/2009-145/000-002

Item no.: 2009-145/000-007

Mini-WSB Inline; for Smart Printer; 1700 pieces on roll; stretchable 5 - 5.2 mm; plain; snap-on type; gray

www.wago.com/2009-145/000-007

Item no.: 2009-145/000-005

Mini-WSB Inline; for Smart Printer; 1700 pieces on roll; stretchable 5 - 5.2 mm; plain; snap-on type; red

www.wago.com/2009-145/000-005

Item no.: 2009-145/000-012

Mini-WSB Inline; for Smart Printer; 1700 pieces on roll; stretchable 5 - 5.2 mm; plain; snap-on type; orange

www.wago.com/2009-145/000-012

Item no.: 2009-145/000-023

Mini-WSB Inline; for Smart Printer; 1700 pieces on roll; stretchable 5 - 5.2 mm; plain; snap-on type; green

www.wago.com/2009-145/000-023

Item no.: 2009-145/000-024

Mini-WSB Inline; for Smart Printer; 1700 pieces on roll; stretchable 5 - 5.2 mm; plain; snap-on type; violet

www.wago.com/2009-145/000-024



Item no.: 2009-115

WMB-Inline; for Smart Printer; 1500 pieces on roll; stretchable 5 - 5.2 mm; plain; snap-on type; white

www.wago.com/2009-115



Item no.: 248-501/000-006

Mini-WSB marking card; as card; not stretchable; plain; snap-on type; blue

www.wago.com/248-501/000-006



Item no.: 248-501/000-007

Mini-WSB marking card; as card; not stretchable; plain; snap-on type; gray

www.wago.com/248-501/000-007



Item no.: 248-501/000-002

Mini-WSB marking card; as card; not stretchable; plain; snap-on type; yellow

www.wago.com/248-501/000-002

Subject to changes. Please also observe the further product documentation!

WAGO Kontakttechnik GmbH & Co. KG

Hansastr. 27

32423 Minden

Phone: +49571 887-0 | Fax: +49571 887-169

Email: info.de@wago.com | Web: www.wago.com

Do you have any questions about our products?

We are always happy to take your call at +49 (571) 887-44222.



Item no.: 248-501/000-012
Mini-WSB marking card; as card; not stretchable; plain; snap-on type; orange

www.wago.com/248-501/000-012



Item no.: 248-501
Mini-WSB marking card; as card; not stretchable; plain; snap-on type; white

www.wago.com/248-501



Item no.: 248-501/000-017
Mini-WSB marking card; as card; not stretchable; plain; snap-on type; light green

www.wago.com/248-501/000-017



Item no.: 248-501/000-005
Mini-WSB marking card; as card; not stretchable; plain; snap-on type; red

www.wago.com/248-501/000-005



Item no.: 248-501/000-024
Mini-WSB marking card; as card; not stretchable; plain; snap-on type; violet

www.wago.com/248-501/000-024



Item no.: 248-501/000-023
Mini-WSB marking card; as card; not stretchable; plain; snap-on type; green

www.wago.com/248-501/000-023



Item no.: 793-5501/000-007
WMB marking card; as card; for terminal block width 5 - 17.5 mm; stretchable 5 - 5.2 mm; plain; snap-on type; gray

www.wago.com/793-5501/000-007



Item no.: 793-5501/000-012
WMB marking card; as card; for terminal block width 5 - 17.5 mm; stretchable 5 - 5.2 mm; plain; snap-on type; orange

www.wago.com/793-5501/000-012



Item no.: 793-5501/000-017
WMB marking card; as card; for terminal block width 5 - 17.5 mm; stretchable 5 - 5.2 mm; plain; snap-on type; green

www.wago.com/793-5501/000-017



Item no.: 793-5501/000-023
WMB marking card; as card; for terminal block width 5 - 17.5 mm; stretchable 5 - 5.2 mm; plain; snap-on type; light green

www.wago.com/793-5501/000-023

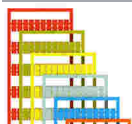

Item no.: 793-5501/000-024
WMB marking card; as card; for terminal block width 5 - 17.5 mm; stretchable 5 - 5.2 mm; plain; snap-on type; violet

www.wago.com/793-5501/000-024

Subject to changes. Please also observe the further product documentation!



Item no.: 793-501/000-002
WMB marking card; as card; not stretchable; plain; snap-on type; yellow

www.wago.com/793-501/000-002



Item no.: 793-501/000-007
WMB marking card; as card; not stretchable; plain; snap-on type; gray

www.wago.com/793-501/000-007



Item no.: 793-501/000-017
WMB marking card; as card; not stretchable; plain; snap-on type; light green

www.wago.com/793-501/000-017



Item no.: 793-501/000-012
WMB marking card; as card; not stretchable; plain; snap-on type; orange

www.wago.com/793-501/000-012



Item no.: 793-501/000-023
WMB marking card; as card; not stretchable; plain; snap-on type; green

www.wago.com/793-501/000-023



Item no.: 793-501/000-006
WMB marking card; as card; not stretchable; plain; snap-on type; blue

www.wago.com/793-501/000-006



Item no.: 793-501/000-005
WMB marking card; as card; not stretchable; plain; snap-on type; red

www.wago.com/793-501/000-005



Item no.: 793-501
WMB marking card; as card; not stretchable; plain; snap-on type; white

www.wago.com/793-501

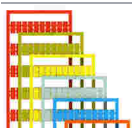

Item no.: 793-501/000-024
WMB marking card; as card; not stretchable; plain; snap-on type; violet

www.wago.com/793-501/000-024

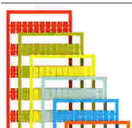

Item no.: 793-5501/000-005
WMB marking card; as card; for terminal block width 5 - 17.5 mm; stretchable 5 - 5.2 mm; plain; snap-on type; red

www.wago.com/793-5501/000-005

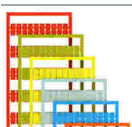

Item no.: 793-5501/000-002
WMB marking card; as card; for terminal block width 5 - 17.5 mm; stretchable 5 - 5.2 mm; plain; snap-on type; yellow

www.wago.com/793-5501/000-002

Subject to changes. Please also observe the further product documentation!



Item no.: 793-5501/000-006

WMB marking card; as card; for terminal block width 5 - 17.5 mm; stretchable 5 - 5.2 mm; plain; snap-on type; blue www.wago.com/793-5501/000-006



Item no.: 793-5501

WMB marking card; as card; for terminal block width 5 - 17.5 mm; stretchable 5 - 5.2 mm; plain; snap-on type; white www.wago.com/793-5501



Item no.: 2009-115/000-012

WMB-Inline; for Smart Printer; 1500 pieces on roll; stretchable 5 - 5.2 mm; plain; snap-on type; orange www.wago.com/2009-115/000-012



Item no.: 2009-115/000-006

WMB-Inline; for Smart Printer; 1500 pieces on roll; stretchable 5 - 5.2 mm; plain; snap-on type; blue www.wago.com/2009-115/000-006

Group marker carrier



Item no.: 2009-193

Group marker carrier www.wago.com/2009-193



Item no.: 2009-192

Group marker carrier www.wago.com/2009-192



Item no.: 2009-191

Group marker carrier www.wago.com/2009-191

Mounting

Mounting accessories



Item no.: 709-156

Cover; Type 3; suitable for cover carrier, type 3; 1 m long; transparent www.wago.com/709-156



Item no.: 709-169

Cover carrier; Type 3; gray www.wago.com/709-169

Tool

Operating tool



Item no.: 210-721

Operating tool; Blade: 5.5 x 0.8 mm; with a partially insulated shaft; multicoloured www.wago.com/210-721

Jumpers

Jumper



Item no.: 2010-402

Jumper; 2-way; insulated; light gray www.wago.com/2010-402



Item no.: 2010-404

Jumper; 4-way; insulated; light gray www.wago.com/2010-404



Item no.: 2010-403

Jumper; 3-way; insulated; light gray www.wago.com/2010-403

Subject to changes. Please also observe the further product documentation!



Item no.: 2010-405/011-000
Star point jumper; 3-way; insulated; light gray

www.wago.com/2010-405/011-000



Item no.: 2010-405
Jumper; 5-way; insulated; light gray

www.wago.com/2010-405



Item no.: 2010-435
Jumper; from 1 to 5; insulated; light gray

www.wago.com/2010-435



Item no.: 2010-433
Jumper; from 1 to 3; insulated; light gray

www.wago.com/2010-433



Item no.: 2010-434
Jumper; from 1 to 4; insulated; light gray

www.wago.com/2010-434

Testing and measuring

Testing accessories



Item no.: 2009-174
Test plug adapter; for 4 mm Ø test plugs; for testing TOPJOB®S rail-mounted terminal blocks; gray

www.wago.com/2009-174



Item no.: 2009-182
Testing tap; for max. 2.5 mm²; tool-free connection for individual test wires 0.08 - 2.5 mm; gray

www.wago.com/2009-182



Item no.: 2010-511
Modular TOPJOB®S connector; modular; for jumper contact slot; 1-pole; 10,00 mm²; gray

www.wago.com/2010-511



Item no.: 2010-549
Spacer module; modular; e.g., for bridging commoned terminal blocks; gray

www.wago.com/2010-549



Item no.: 210-136
Test plug; 2 mm Ø; with 500 mm cable; red

www.wago.com/210-136

Downloads

Documentation

Bid Text

2110-5201 docx - Datei	May 20, 2019	docx 15.4 kB	Download
---------------------------	--------------	-----------------	----------

2110-5201 X81 - Datei	May 20, 2019	xml 4.1 kB	Download
--------------------------	--------------	---------------	----------

Additional Information

Technical explanations	Apr 3, 2019	pdf	Download
------------------------	-------------	-----	----------

Subject to changes. Please also observe the further product documentation!

CAD/CAE-Data

CAD data

2D/3D Models 2110-5201	URL	Download
------------------------	---------------------	--------------------------

CAE data

ZUKEN Portal 2110-5201	URL	Download
------------------------	---------------------	--------------------------

EPLAN Data Portal 2110-5201	URL	Download
-----------------------------	---------------------	--------------------------

Environmental Product Compliance

Compliance Search

Environmental Product Compliance 2110-5201	URL	Download
--	---------------------	--------------------------

2-conductor through terminal block; with lever and push-button; 10 mm²; with test port; side and center marking; for DIN-rail 35 x 15 and 35 x 7.5; Push-in CAGE CLAMP®; 10,00 mm²; gray

Installation Notes

Conductor termination

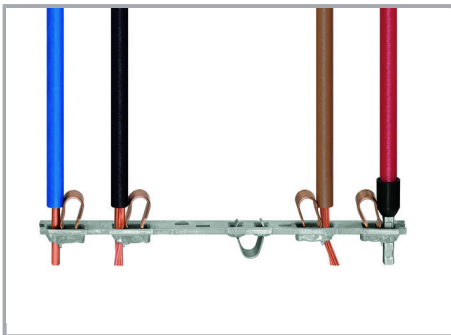

All conductor types at a glance



Push-in termination of solid conductors



Push-in termination of fine-stranded conductors with ferrules

Subject to changes. Please also observe the further product documentation!



Pull the lever up until it stops, then connect the fine-stranded conductor.

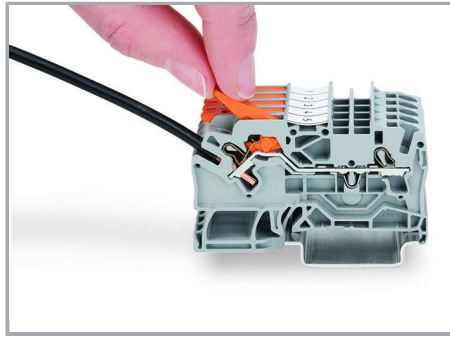

Push the lever back down – done!



Push the lever back down – done!

Commoning



Insert a push-in type jumper bar and push down until it hits the backstop.



Commoning with step-down jumpers.

Testing

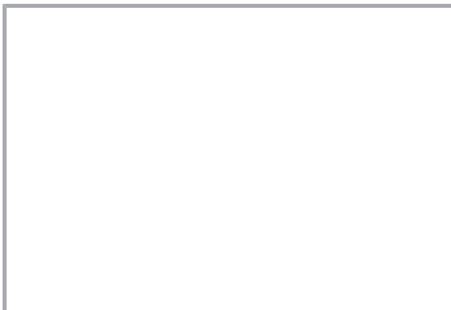

Testing with a 2 mm Ø test plug (max. 42 V).

Marking

Subject to changes. Please also observe the further product documentation!

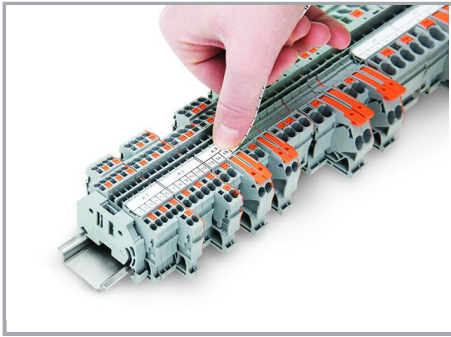

Snapping a marking strip into a marker slot.

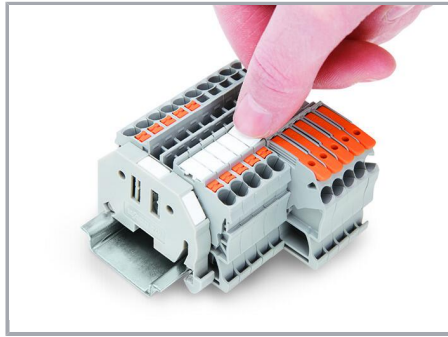

Snapping a marking strip into the marker slot.

Product family

TOPJOB® S

TOPJOB® S: In various industrial applications and modern building installations, WAGO's wide and versatile range of rail-mount terminal blocks provides more than just reliable electrical connections.

[Show all products from the family](#)

Subject to changes. Please also observe the further product documentation!