

Grove - RGB LED Ring (16-WS2813 Mini)

SKU 104020171

Grove - RGB LED Ring (16-WS2813 Mini) is a cost-effective full color LED ring with 16 chainable and programmable WS2813 mini LEDs.

"I don't dance,
but here I am.
Spinning you around and around in circles"

16 diamond-like full-color WS2813 Mini LEDs are placed around a 58 mm diameter ring, my friends, let's dance with those shining LED rings.

We've already released the Grove - RGB LED Ring (20 - WS2813 Mini), now the Grove - RGB LED Ring family has welcomed three new members:

- Grove - RGB LED Ring (16-WS2813 Mini)
- Grove - RGB LED Ring (24-WS2813 Mini)
- Grove - Ultimate RGB LED Ring

The WS2813B-Mini intelligent control LED is an upgraded version of WS2812B, the control circuit and RGB chip are integrated into a package of 3535 components. With the help of the build-in control circuit, each LED is addressable. So you can control the lighting and color of specific LED lights as you like, creating endless lighting effects. A significant advantage of WS2813B-Mini compared to traditional LED is the support for signal break-point continuous transmission. This means that even if one or two LEDs are damaged, the entire LED ring will still work properly.

Each LED is chainable and we also keep the chainable pads on the back of the LED rings, so you can cascade several LED rings to make it even cooler. Since all those Grove - RGB LED Rings are based on WS2813 Mini, you can also connect the rings of different diameters together.

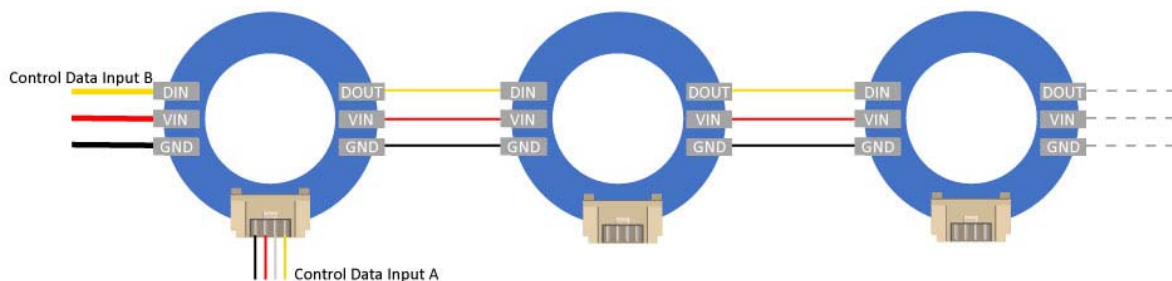

When multiple light rings are connected together, the control signal can be input from the Grove SIG pin or from the DIN input. However, Grove VCC has insufficient power supply and needs to input power from VIN.

On top of that, with the on-board Grove connector and cable, all these wonderful things only need to be plugged and unplugged.

Features

- 256 gray levels, $256 \times 256 \times 256 = 16777216$ full-color display
- Built-in control circuit in a 3535 components
- Chainable, can be cascaded with multiple LED rings
- Support 5V/3.3V power in, support 5V/3.3V control data level.
- Dual-signal wires, signal break-point continuous transmission

Signal break-point continuous transmission

Work

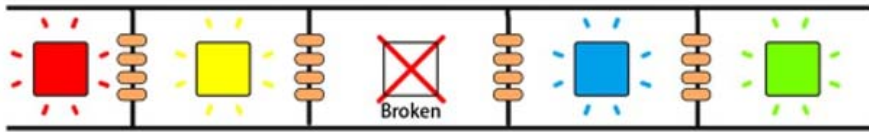

Work



Not Work

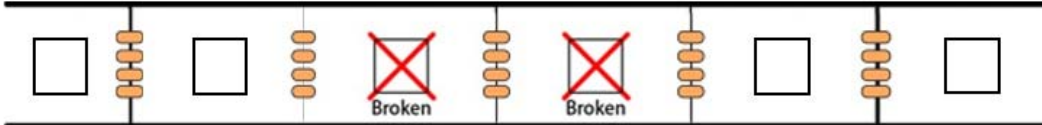

As long as not two or more adjacent LEDs are broken, the remaining LEDs will be able to work normally

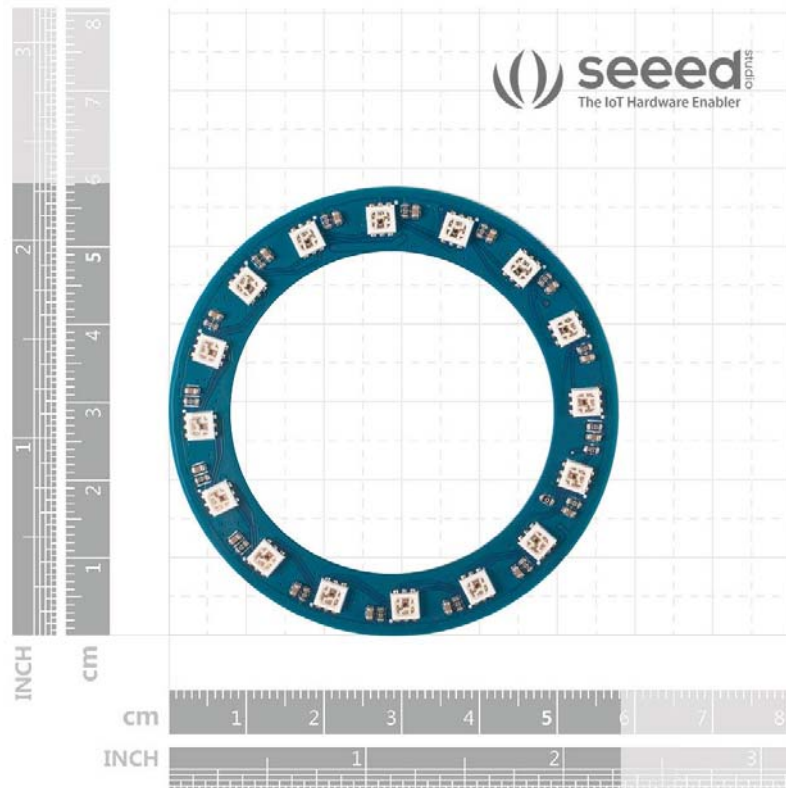

Hardware Overview

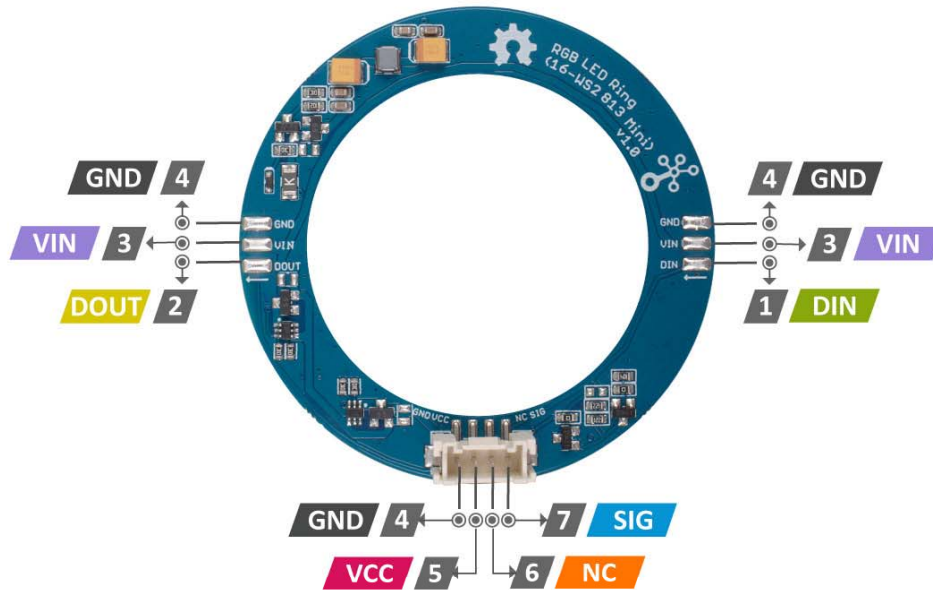

- 1** : Control data signal input*¹
- 2** : Control data signal output
- 3** : Power supply 5V/3.3V*²
- 4** : Connected to the system GND
- 5** : Power supply from Grove 5V/3.3V*²
- 6** : Not connected
- 7** : Control data signal input
from Grove connector*¹

Note

- 1- Actually, the control data signal inputs are connected. So please do not input different signals at the same time.
- 2- The two power ports are isolated, and the Grove VCC can only supply up to 400mA, so please use VIN when multiple LED rings are cascaded.

Dimension

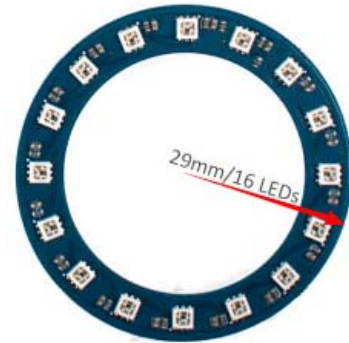
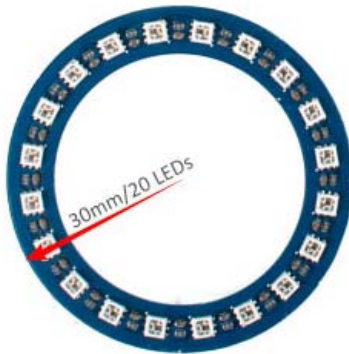
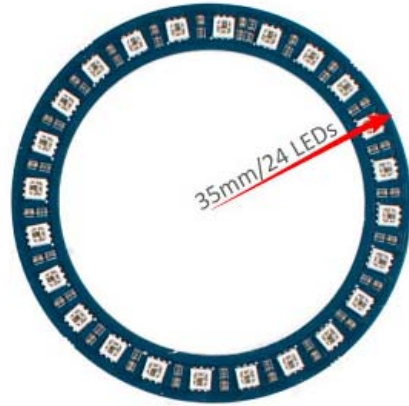
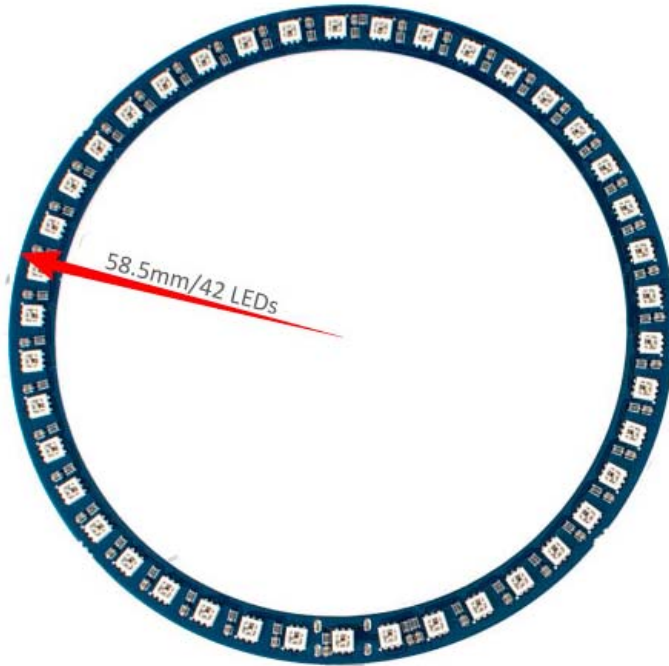

ECCN/HTS

ECCN	EAR99
HSCODE	9405600000
UPC	

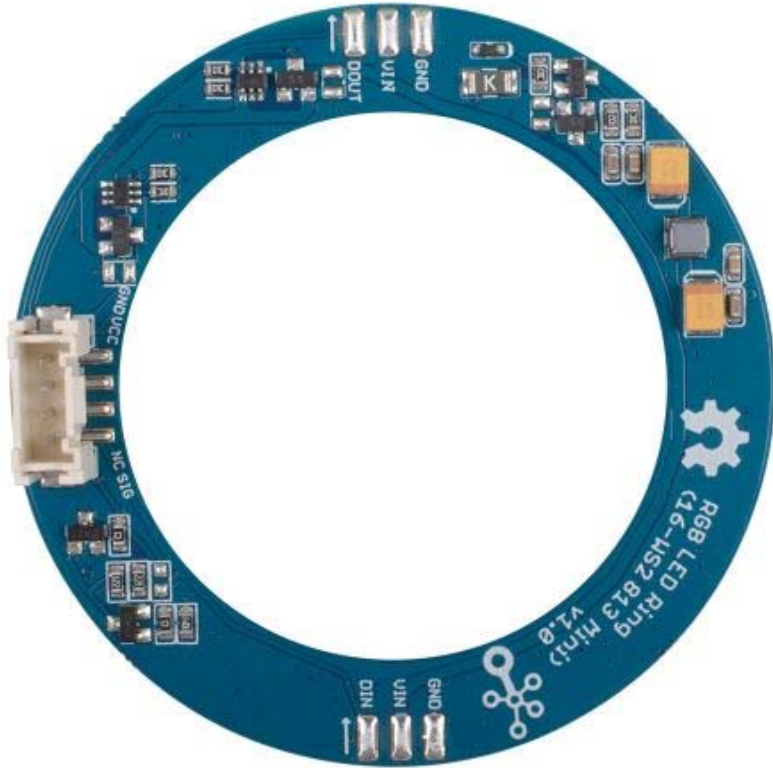
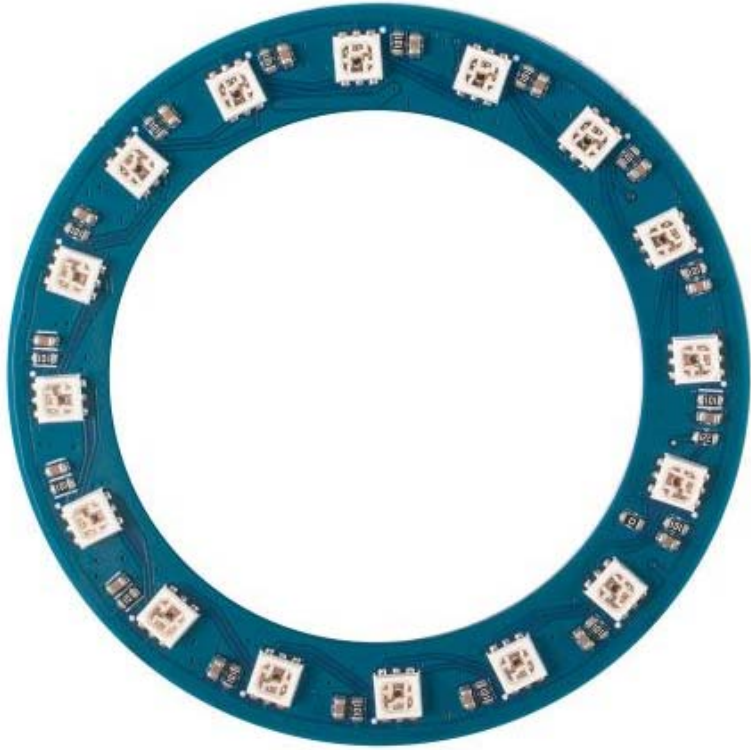

<https://www.seedstudio.com/Grove-RGB-LED-Ring-16-WS2813-Mini-p-4201.html/9-13-19>