

SERIES: ETSA 18W-C14 | **DESCRIPTION:** DESK-TOP ADAPTER

FEATURES

- up to 18 W power
- universal input (90-264 Vac)
- compact size
- single regulated output from 5 to 15V
- over voltage and short circuit protections
- UL/cUL, TUV and PSE safety approvals
- level V efficiency
- custom designs available

V-Infinity

MODEL	output voltage	output current max	output power max	ripple ¹ max	efficiency level
	(Vdc)	(A)	(W)	(mVp-p)	
ETSA050360U	5	3.6	18	100	V
ETSA060300U	6	3	18	100	V
ETSA120150U	12	1.5	18	100	V
ETSA150120U	15	1.2	18	100	V

1. at full load, 100 ~ 240 Vac input, 20 MHz bandwidth oscilloscope, each output terminated with a 10 μ F aluminum electrolytic and 0.1 μ F ceramic capacitors.

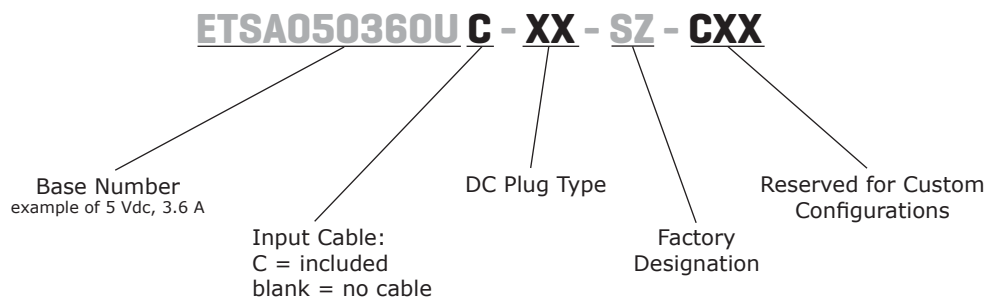
PART NUMBER KEY

INPUT

parameter	conditions/description	min	typ	max	units
voltage		90		264	Vac
frequency		47		63	Hz
input current				0.5	A
inrush current	at 115 Vac, cool start			40	A
	at 230 Vac, cool start			80	A
no load power consumption				0.3	W

OUTPUT

parameter	conditions/description	min	typ	max	units
line regulation	5 V output		±5		%
	all other outputs		±1		%
load regulation			±5		%

PROTECTIONS

parameter	conditions/description
over voltage protection	output voltage clamped by an internal protection zener
short circuit protection	output shut down, auto restart

SAFETY & COMPLIANCE

parameter	conditions/description	min	typ	max	units
isolation voltage	input to output at 10 mA for 1 minute			1,500	Vac
insulation resistance	input to output at 500 Vdc	100			MΩ
safety approvals	UL/cUL, GS, PSE				
EMI/EMC	FCC Class B, CE				
leakage current	5 V output			3.5	mA
	all other outputs			0.25	mA
RoHS compliant	yes				

ENVIRONMENTAL

parameter	conditions/description	min	typ	max	units
operating temperature		0		40	°C
storage temperature		-10		70	°C
operating humidity		20		80	%
storage humidity		10		90	%

MECHANICAL

parameter	conditions/description	min	typ	max	units
dimensions	80.6 x 50 x 31 mm				
weight ¹			115		g

1. weight does not include AC Cord

MECHANICAL DRAWING

units: mm

input plug IEC320 / C14

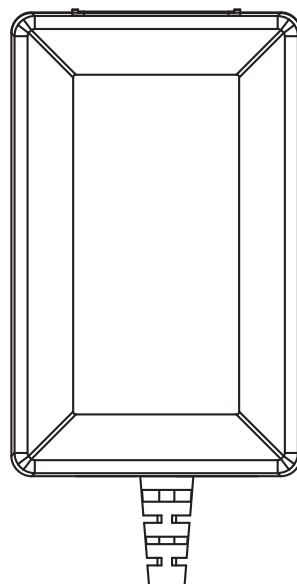
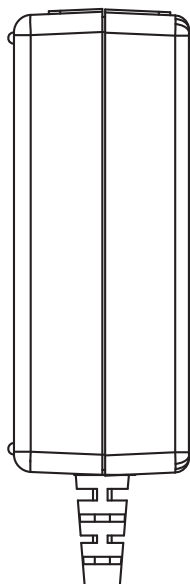
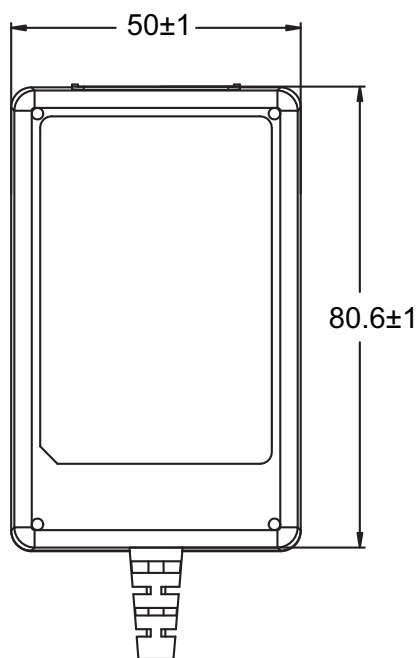
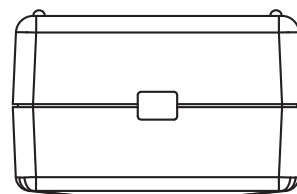
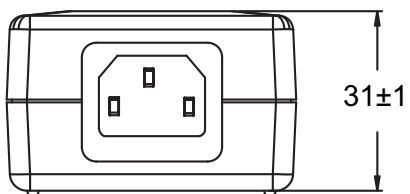

DC CORD

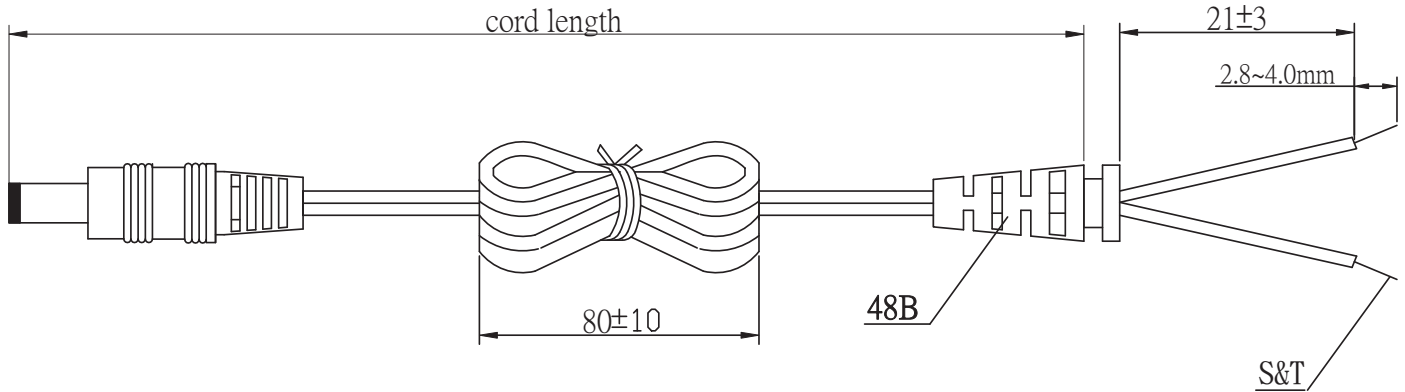

MODEL NO.	CABLE GAUGE	CORD LENGTH
ETSA050360U	18 AWG	1,000 mm ±100
ETSA060300U	18 AWG	1,000 mm ±100
ETSA120150U	20 AWG	1,530 mm ±100
ETSA150120U	20 AWG	1,530 mm ±100

AC CORD

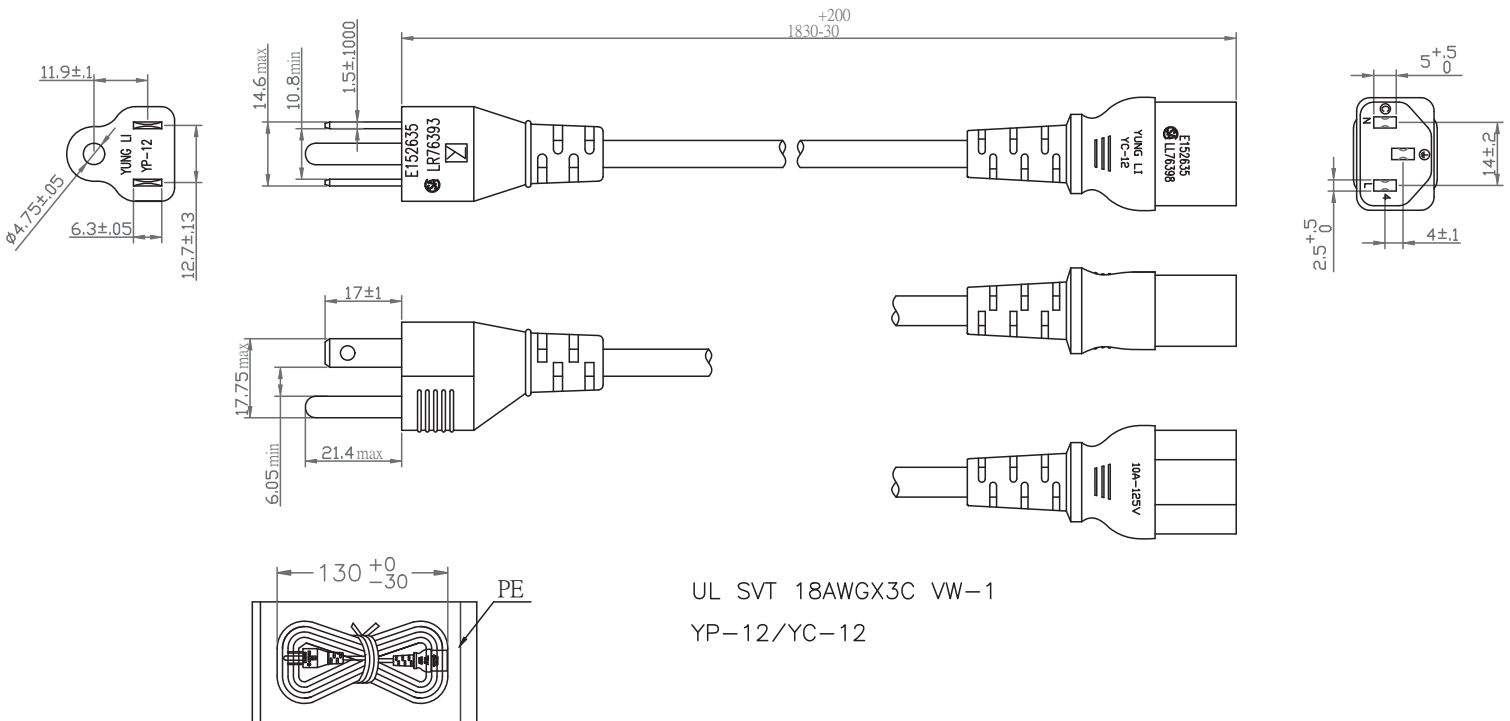

UL SVT 18AWGX3C VW-1
YP-12/YC-12

OUTPUT PLUG OPTIONS

3.5 mm Phono Plug

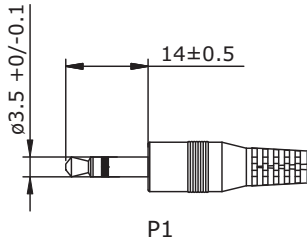

P1

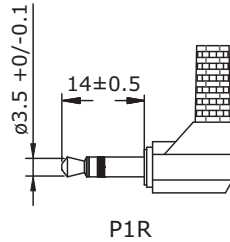

P1R

*Tip positive

Standard DC Plug

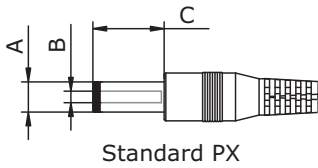

Standard PX

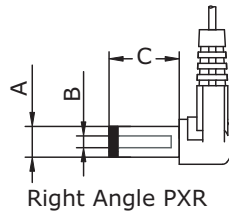

Right Angle PXR

	A	B	C	Unit
P5/P5R	5.5	2.1	9.5	mm
P6/P6R	5.5	2.5	9.5	mm
P7/P7R	3.5	1.3	9.5	mm
P8/P8R	3.8	1.35	9.5	mm
P9/P9R	3.8	1.05	9.5	mm

Locking DC Plug

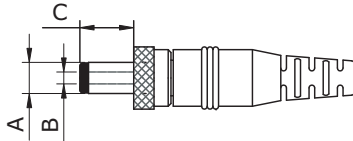

	A	B	C	Unit
P10	5.5	2.1	9.5	mm
P11	5.5	2.5	9.5	mm

EIAJ Plugs

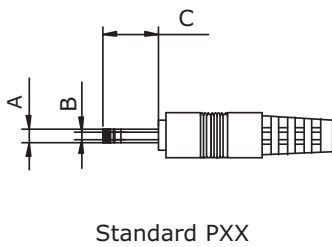

Standard PXX

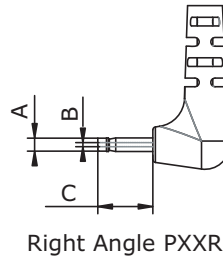

Right Angle PXXR

	EIAJ	A	B	C	D	Unit
P12/P12R	EIAJ-1	2.35	0.7	9.5	NA	mm
P13/P13R	EIAJ-2	4.0	1.7	9.5	5.0	mm
P14/P14R	EIAJ-3	4.75	1.7	9.5	5.0	mm

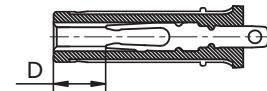

Stripped and Tinned

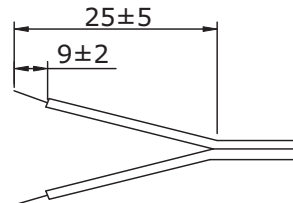

DC PLUG TYPE

ST
|
stripped and tinned

PXX X X

Plug type Plug angle:
"blank" = standard
R = right angle Plug polarity:
"blank" = N/A
P = center positive ⊖ ⊕ ⊕
N = center negative ⊕ ⊖ ⊖

*Contact CUI for additional output plug options.

REVISION HISTORY

rev.	description	date
1.0	initial release	12/05/2011

The revision history provided is for informational purposes only and is believed to be accurate.



Headquarters
20050 SW 112th Ave.
Tualatin, OR 97062
800.275.4899

Fax 503.612.2383
cui.com
techsupport@cui.com

This device complies with part 15 of the FCC Rules. Operation is subject to the following two conditions:

- (1) This device may not cause harmful interference, and
- (2) this device must accept any interference received, including interference that may cause undesired operation.

CUI offers a one (1) year limited warranty. Complete warranty information is listed on our website.

CUI reserves the right to make changes to the product at any time without notice. Information provided by CUI is believed to be accurate and reliable. However, no responsibility is assumed by CUI for its use, nor for any infringements of patents or other rights of third parties which may result from its use.

CUI products are not authorized or warranted for use as critical components in equipment that requires an extremely high level of reliability. A critical component is any component of a life support device or system whose failure to perform can be reasonably expected to cause the failure of the life support device or system, or to affect its safety or effectiveness.