

2SD468

NPN Epitaxial Silicon Transistor

Features

- Low Frequency Power Amplifier.
- Lead Free Finish/RoHS Compliant ("P" Suffix designates RoHS Compliant. See ordering information)
- Case Material: Molded Plastic. UL Flammability Classification Rating 94V-0 and MSL Rating 1
- Complementary pair with 2SB562
- Halogen free available upon request by adding suffix "-HF"

Maximum Ratings

Symbol	Rating	Rating	Unit
V _{CEO}	Collector-Emitter Voltage	20	V
V _{CBO}	Collector-Base Voltage	25	V
V _{EBO}	Emitter-Base Voltage	5.0	V
I _C	Collector Current	1.0	A
P _C	Collector power dissipation	0.9	W
T _J	Junction Temperature	-55 to +150	°C
T _{STG}	Storage Temperature	-55 to +150	°C

Electrical Characteristics @ 25°C Unless Otherwise Specified

Symbol	Parameter	Min	Typ	Max	Units
--------	-----------	-----	-----	-----	-------

OFF CHARACTERISTICS

BV _{CBO}	Collector-Base Breakdown Voltage (I _C =10 μAdc, I _E =0)	20	---	---	Vdc
BV _{CEO}	Collector-Emitter Breakdown Voltage (I _C =1mAdc, I _B =0)	25	---	---	Vdc
BV _{EBO}	Emitter-Base Breakdown Voltage (I _E =0.01mAdc, I _C =0)	5.0	---	---	Vdc
I _{CBO}	Collector Cutoff Current (V _{CB} =20Vdc, I _E =0)	---	---	1000	nAdc
I _{EBO}	Emitter Cutoff Current (V _{EB} =4.0Vdc, I _C =0)	---	---	1000	nAdc

ON CHARACTERISTICS

h _{FE}	DC Current gain (I _C =500mAdc, V _{CE} =2.0Vdc)	85	---	240	---
V _{BE(on)}	Base-Emitter On Voltage (V _{CE} =2.0Vdc, I _C =500mAdc)	---	---	1.0	Vdc
V _{CE(sat)}	Collector-Emitter Saturation Voltage (I _C =0.8Adc, I _B =80mAdc)	---	---	0.5	Vdc
f _T	Current Gain Bandwidth Product (V _{CE} =2.0Vdc, I _C =500mAdc)	---	190	---	MHz
C _{ob}	Output Capacitance (V _{CB} =10Vdc, I _E =0, f=1.0MHz)	---	22	---	pF

(1) h_{FE} Classification B: 85~170, C: 120~240

TO-92L

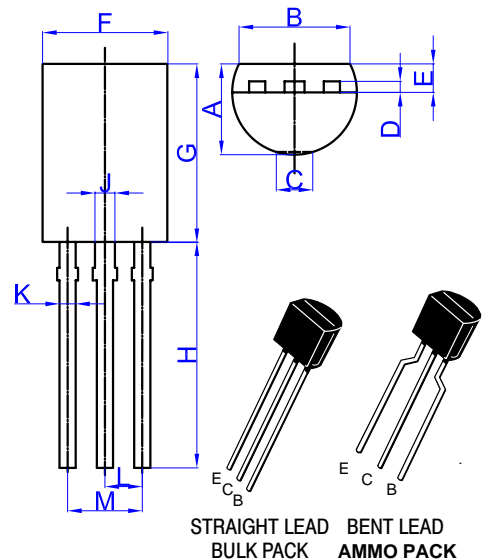

DIM	MM		INCHES		NOTE
	MIN	MAX	MIN	MAX	
A	3.700	4.100	.146	.161	
B	4.000	---	.157	---	
C	0.000	0.300	0.000	0.012	
D	0.350	0.450	.014	.018	
E	1.280	1.580	.050	.062	
F	4.700	5.100	.185	.201	
G	7.800	8.200	.307	.323	
H	13.80	14.20	.543	.559	
J	.600	.800	.024	.031	
K	0.350	.550	.014	.022	
L	1.270		.050		Straight Lead
	2.200	2.800	.086	.110	
M	2.440		.096		Straight Lead
	4.400	5.600	.173	.220	

* For ammo packing detailed specification, click here to visit our website of product packaging for details.

2SD468

Typical Characteristics

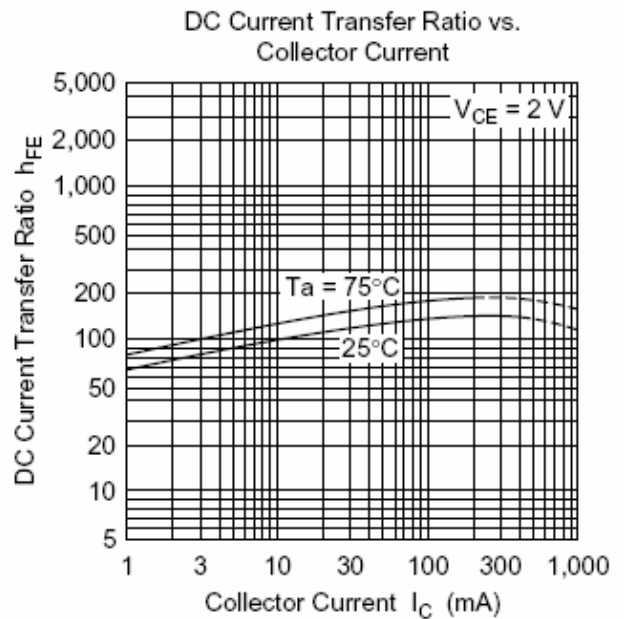
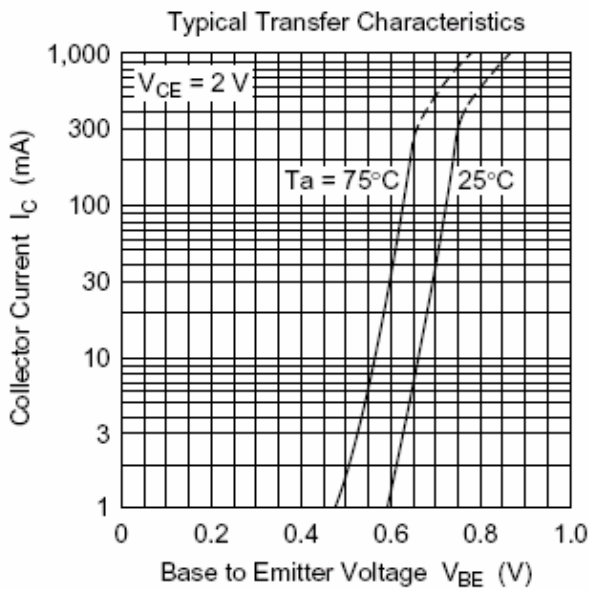
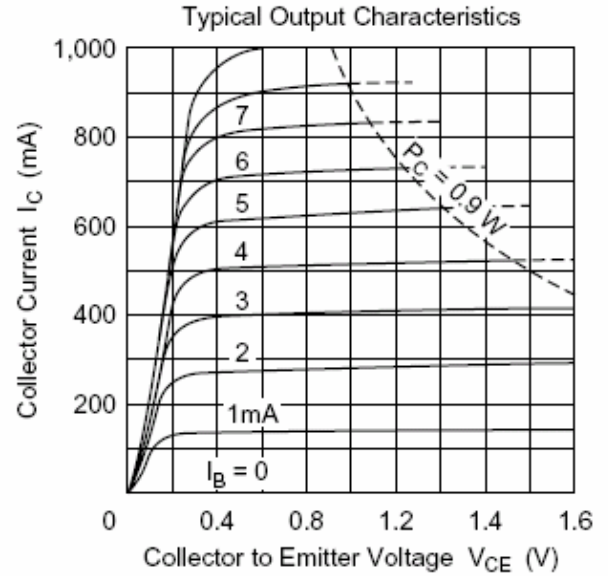
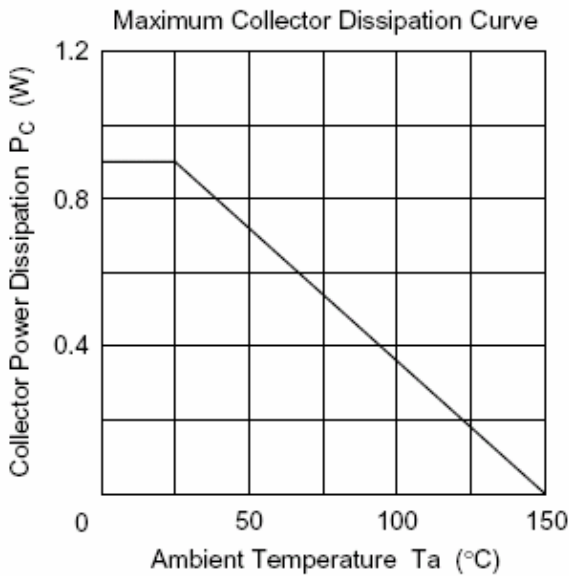

Typical Characteristics

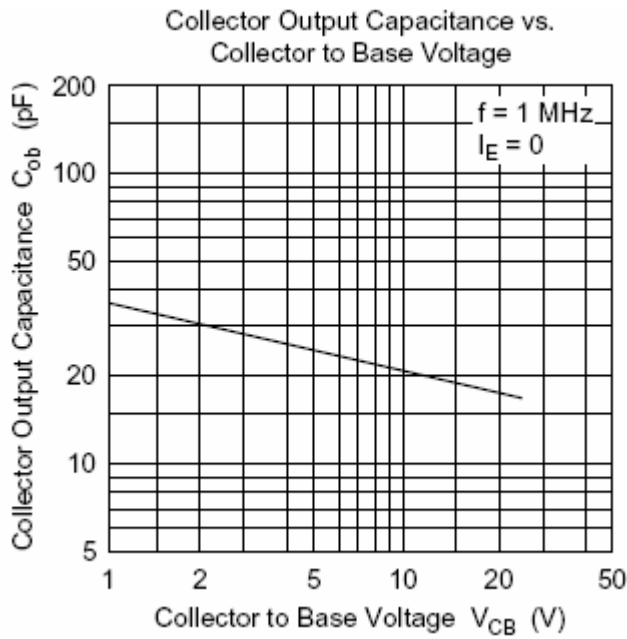
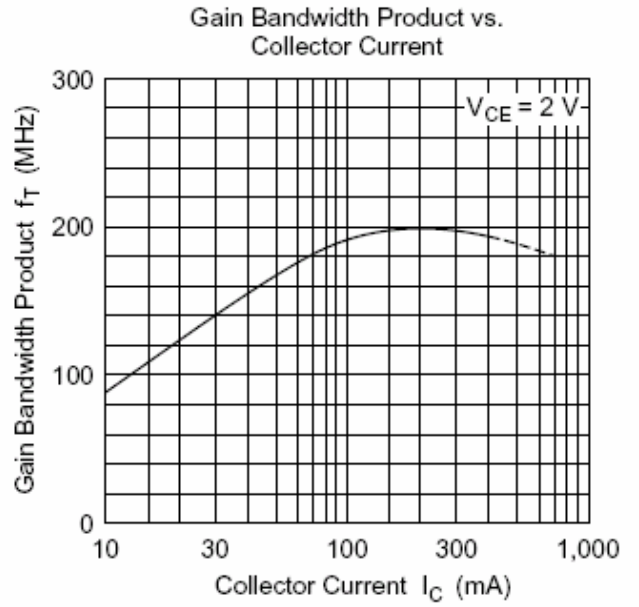
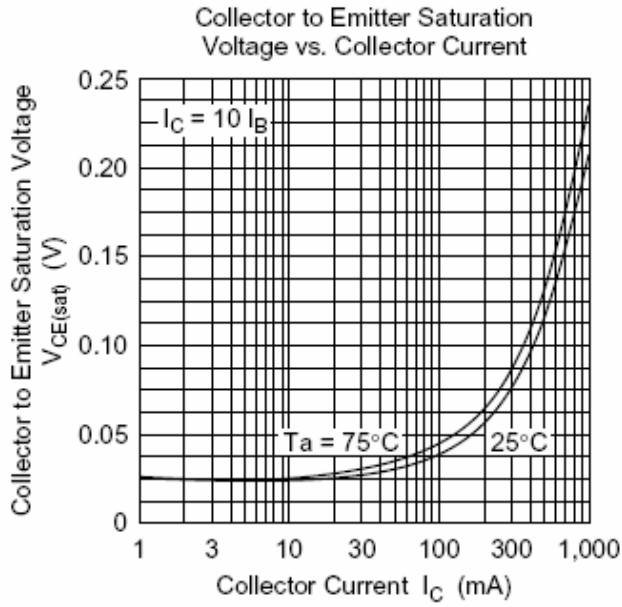



TM

Micro Commercial Components

Ordering Information :

Device	Packing
Part Number-AP	Ammo Packing: 2Kpcs/Ammo Box
Part Number-BP	Bulk: 50Kpcs/Carton

Note : Adding "-HF" suffix for halogen free, eg. Part Number-AP-HF

IMPORTANT NOTICE

Micro Commercial Components Corp. reserves the right to make changes without further notice to any product herein to make corrections, modifications, enhancements, improvements, or other changes. **Micro Commercial Components Corp.** does not assume any liability arising out of the application or use of any product described herein; neither does it convey any license under its patent rights, nor the rights of others. The user of products in such applications shall assume all risks of such use and will agree to hold **Micro Commercial Components Corp.** and all the companies whose products are represented on our website, harmless against all damages.

LIFE SUPPORT

MCC's products are not authorized for use as critical components in life support devices or systems without the express written approval of Micro Commercial Components Corporation.

CUSTOMER AWARENESS

Counterfeiting of semiconductor parts is a growing problem in the industry. Micro Commercial Components (MCC) is taking strong measures to protect ourselves and our customers from the proliferation of counterfeit parts. MCC strongly encourages customers to purchase MCC parts either directly from MCC or from Authorized MCC Distributors who are listed by country on our web page cited below. Products customers buy either from MCC directly or from Authorized MCC Distributors are genuine parts, have full traceability, meet MCC's quality standards for handling and storage. **MCC will not provide any warranty coverage or other assistance for parts bought from Unauthorized Sources.** MCC is committed to combat this global problem and encourage our customers to do their part in stopping this practice by buying direct or from authorized distributors.

www.mccsemi.com