NI-9266

Specifications

2022-10-07

Contents

NI 9266.....	3
NI-9266 Specifications.....	8

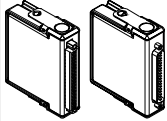

NI 9266



- DSUB or screw terminal connectivity
- 250 V RMS, CAT II, channel-to-earth isolation (screw terminal); 60 V DC, CAT I, channel-to-earth isolation (DSUB)
- 8 channels, 24 kS/s per channel simultaneous analog output
- 0 mA to 20 mA output range, 16-bit resolution
- Open-loop detection with interrupt, 0.0 mA power-on
- -40 °C to 70 °C operating range, 5 g vibration, 50 g shock

Note In this document, the NI-9266 with screw terminal and the NI-9266 with DSUB are referred to inclusively as the NI-9266.

The NI-9266 is ideal for interfacing and controlling industrial current-driven actuators. The module has built-in open-loop detection, which generates an interrupt in software when an open loop is detected as well as zeroing outputs to ensure safety and avoid driving actuators at system power on. The NI-9266 includes channel-to-earth ground isolation for safety and noise immunity.

 <p>Kit Contents</p>	<ul style="list-style-type: none"> • NI 9266 • NI 9266 Getting Started Guide
 <p>Accessories</p>	<ul style="list-style-type: none"> • NI 9928 Backshell Kit (784819-01) (Screw Terminal) OR • NI 9923 Front Mount Screw Terminal Block (DSUB) • DIN-Rail Mount Terminal Block (DSUB)

C SERIES ANALOG OUTPUT FOR CONTROL APPLICATIONS MODULE COMPARISON								
Product Name	Module Type	Signal Ranges	Channels	Update Rate	Settling Time		Isolation	Connectivity
					Small Step	Full Scale		
NI 9263	Voltage Output	± 10 V	4	100 kS/s/ch	10 μ s	20 μ s	250 Vrms CH-Earth	Screw-Terminal, Spring-Terminal
NI 9264	Voltage Output	± 10 V	16	25 kS/s/ch	13 μ s	20 μ s	250 Vrms CH-Earth (Spring) 60 VDC CH-Earth (DSUB)	Spring-Terminal, 37-Pin DSUB
NI 9265	Current Output	0 mA to 20 mA	4	100 kS/s/ch	5 μ s	10 μ s	250 Vrms CH-Earth	Screw-Terminal, Spring-Terminal
NI 9266	Current Output	0 mA to 20 mA	8	24 kS/s/ch	40 μ s	1000 μ s	250 Vrms CH-Earth	Screw-Terminal
NI 9269	Voltage Output	± 10 V	4	100 kS/s/ch	10 μ s	20 μ s	250 Vrms CH-CH 250 Vrms CH-Earth	Screw-Terminal

NI C Series Overview



NI provides more than 100 C Series modules for measurement, control, and communication applications. C Series modules can connect to any sensor or bus and allow for high-accuracy measurements that meet the demands of advanced data acquisition and control applications.

- Measurement-specific signal conditioning that connects to an array of sensors and signals
- Isolation options such as bank-to-bank, channel-to-channel, and channel-to-earth ground
- -40 °C to 70 °C temperature range to meet a variety of application and environmental needs
- Hot-swappable

The majority of C Series modules are supported in both CompactRIO and CompactDAQ platforms and you can move modules from one platform to the other with no modification.

CompactRIO



CompactRIO combines an open-embedded architecture with small size, extreme ruggedness, and C Series modules in a platform powered by the NI LabVIEW reconfigurable I/O (RIO) architecture. Each system contains an FPGA for custom timing, triggering, and processing with a wide array of available modular I/O to meet any embedded application requirement.

CompactDAQ

CompactDAQ is a portable, rugged data acquisition platform that integrates connectivity, data acquisition, and signal conditioning into modular I/O for directly interfacing to any sensor or signal. Using CompactDAQ with LabVIEW, you can easily customize how you acquire, analyze, visualize, and manage your measurement data.



Software

LabVIEW Professional Development System for Windows

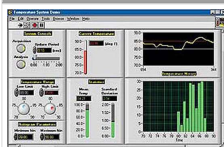

- Use advanced software tools for large project development
- Generate code automatically using DAQ Assistant and Instrument I/O Assistant
- Use advanced measurement analysis and digital signal processing
- Take advantage of open connectivity with DLLs, ActiveX, and .NET objects
- Build DLLs, executables, and MSI installers

NI LabVIEW FPGA Module

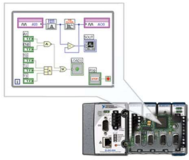

- Design FPGA applications for NI RIO hardware
- Program with the same graphical environment used for desktop and real-time applications
- Execute control algorithms with loop rates up to 300 MHz
- Implement custom timing and triggering logic, digital protocols, and DSP algorithms
- Incorporate existing HDL code and third-party IP including Xilinx IP generator functions
- Purchase as part of the LabVIEW Embedded Control and Monitoring Suite

NI LabVIEW Real-Time Module

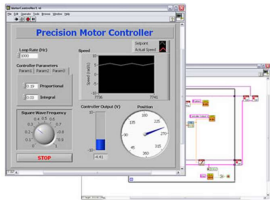

- Design deterministic real-time applications with LabVIEW graphical programming
- Download to dedicated NI or third-party hardware for reliable execution and a wide selection of I/O
- Take advantage of built-in PID control, signal processing, and analysis functions
- Automatically take advantage of multicore CPUs or set processor affinity manually
- Take advantage of real-time OS, development and debugging support, and board support
- Purchase individually or as part of a LabVIEW suite

Circuitry

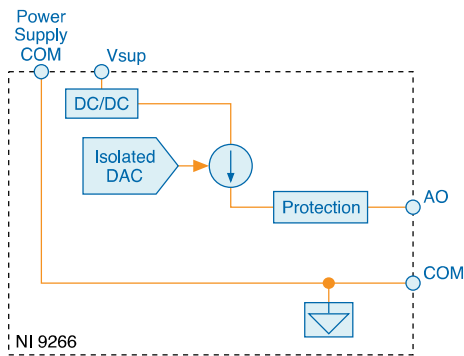

- Each AO channel has a digital-to-analog converter (DAC) that produces a current signal.
- Each channel also has overvoltage and short-circuit protection.

Dynamic Power Supply Control

The NI 9266 uses a technique called dynamic power supply control featuring a DC-DC converter circuit, which allows reductions in power consumption from standard designs. The NI 9266 circuitry senses the output voltage and regulates the internal DC-DC converter in order to limit the power dissipation while maintaining the necessary compliance voltage for the given load and output current. The NI 9266 has a dedicated DC-DC converter for each channel, allowing it to dynamically adjust to a specific use case.

The DC-DC converters have a slower slew rate than linear stages, so the module will respond slower to a step response than a classic linear output module, resulting in slower settling times.

Current Loop Status

The NI 9266 provides channel-based indicators for open current loop condition or if the loop is out of regulation. This could be the result of a wire disconnect or a violation of the maximum load or maximum compliance voltage. When an output channel is set to a nonzero current value, an Open Current Loop status bit corresponding to that channel can be read in software. The external power supply connected to the NI 9266 terminals is monitored for non-compliance to the voltage range shown in the Specifications section. The external power supply is part of the

current loop, so a fault at the power supply terminals will also trigger the Open Current Loop status bits on all channels. The Power Supply Fault status bit can also be read in the software. Refer to the documentation for the software you are using with the NI 9266 for information about reading status indicators.

NI-9266 Specifications

The following specifications are typical for the range -40 °C to 70 °C unless otherwise noted. All voltages are relative to COM unless otherwise noted.

Caution Do not operate the NI-9266 in a manner not specified in this document. Product misuse can result in a hazard. You can compromise the safety protection built into the product if the product is damaged in any way. If the product is damaged, return it to NI for repair.

Output Characteristics

Number of channels	8 analog output channels
DAC resolution	16 bits
Type of DAC	String
Power-on output state	0
Startup current	0.0 mA
Power-down current	0.0 mA
Full-scale output current	
Minimum	20.3 mA
Typical	20.77 mA
Maximum	21.2 mA
Output range	0 mA to 20 mA
Compliance voltage ^[1]	12 V DC maximum

Maximum load		600 Ω	
Measurement Conditions		Percent of Reading (Gain Error)	Percent of Range ^[2] (Offset Error)
Calibrated	Maximum (-40 °C to 70 °C)	0.27%	0.36%
	Typical (25 °C, ± 5 °C)	0.035%	0.02%
Uncalibrated ^[3]	Maximum (-40 °C to 70 °C)	0.76%	1.4%
	Typical (25 °C, ± 5 °C)	0.2%	0.64%

Table 1. Accuracy

Stability		
Gain drift	35 ppm/°C	
Offset drift	47 ppm/°C	
External power supply voltage range (V_{sup} -to-COM)		9 V DC to 30 V DC
Protection (AO-to-COM, V_{sup}-to-COM)		
Overvoltage	± 36 V	
Short-circuit	Indefinitely	
Number of Channels	Update Time for R Series Expansion Chassis	Update Time for Any Other Chassis
One	7.5 μ s	6 μ s
Four	26.5 μ s	21.5 μ s
Eight	51.5 μ s	41.5 μ s

Table 2. Update Time

Noise	600 nA RMS
Crosstalk	-90 dB
Settling time (to 1 LSB)	
Full-scale step	1 ms
1 mA step	40 μ s

Glitch energy	Unmeasurable
Monotonicity	16 bits
DNL	1 LSB maximum
INL	±16 LSB
External power supply fault response time	100 ms
Open Current Loop response time	2.5 ms

Power Requirements

Power consumption from chassis	
Active mode	230 mW maximum
Sleep mode	25 μ W maximum
Thermal dissipation (at 70 °C)	
Active mode	1.5 W maximum
Sleep mode	10 mW maximum
Power consumption from external power supply	
Active mode	3.1 W maximum ^[4]
Sleep mode	20 mW

NI-9266 with Screw Terminal Safety Voltages

Connect only voltages that are within the following limits:

AO-to-COM and V_{sup} -to-COM	±36 V DC maximum
Isolation	
Channel-to-channel	None
Channel-to-earth ground, V_{sup}-to-earth ground, or COM-to-earth ground	

Continuous	250 V RMS, Measurement Category II
Withstand up to 3,000 m	3,000 V RMS, verified by a 5 s dielectric withstand test

Caution Do not connect the product to signals or use for measurements within Measurement Categories III or IV.

Attention Ne pas connecter le produit à des signaux dans les catégories de mesure III ou IV et ne pas l'utiliser pour effectuer des mesures dans ces catégories.

Measurement Category II is for measurements performed on circuits directly connected to the electrical distribution system. This category refers to local-level electrical distribution, such as that provided by a standard wall outlet, for example, 115 V for U.S. or 230 V for Europe.

NI-9266 with DSUB Safety Voltages

Connect only voltages that are within the following limits.

AO-to-COM and V_{sup} -to-COM	±36 V DC maximum
Isolation	
Channel-to-channel	None
Channel-to-earth ground	
Continuous	60 V DC, Measurement Category I
Withstand up to 3,000 m	1,000 V RMS, verified by a 5 s dielectric withstand test
Withstand up to 5,000 m	860 V RMS

Caution Do not connect the product to signals or use for measurements within Measurement Categories II, III, or IV.

Attention Ne pas connecter le produit à des signaux dans les catégories de mesure II, III ou IV et ne pas l'utiliser pour effectuer des mesures dans ces catégories.

Warning Do not connect the product to signals or use for measurements within Measurement Categories II, III, or IV, or for measurements on MAINS circuits or on circuits derived from Overvoltage Category II, III, or IV which may have transient overvoltages above what the product can withstand. The product must not be connected to circuits that have a maximum voltage above the continuous working voltage, relative to earth or to other channels, or this could damage and defeat the insulation. The product can only withstand transients up to the transient overvoltage rating without breakdown or damage to the insulation. An analysis of the working voltages, loop impedances, temporary overvoltages, and transient overvoltages in the system must be conducted prior to making measurements.

Mise en garde Ne pas connecter le produit à des signaux dans les catégories de mesure II, III ou IV et ne pas l'utiliser pour des mesures dans ces catégories, ou des mesures sur secteur ou sur des circuits dérivés de surtensions de catégorie II, III ou IV pouvant présenter des surtensions transitoires supérieures à ce que le produit peut supporter. Le produit ne doit pas être raccordé à des circuits ayant une tension maximale supérieure à la tension de fonctionnement continu, par rapport à la terre ou à d'autres voies, sous peine d'endommager et de compromettre l'isolation. Le produit peut tomber en panne et son isolation risque d'être endommagée si les tensions transitoires dépassent la surtension transitoire nominale. Une analyse des tensions de fonctionnement, des impédances de boucle, des surtensions temporaires et des surtensions transitoires dans le système doit être effectuée avant de procéder à des mesures.

Measurement Category I is for measurements performed on circuits not directly connected to the electrical distribution system referred to as **MAINS** voltage. MAINS

is a hazardous live electrical supply system that powers equipment. This category is for measurements of voltages from specially protected secondary circuits. Such voltage measurements include signal levels, special equipment, limited-energy parts of equipment, circuits powered by regulated low-voltage sources, and electronics.

Note Measurement Categories CAT I and CAT O are equivalent. These test and measurement circuits are for other circuits not intended for direct connection to the MAINS building installations of Measurement Categories CAT II, CAT III, or CAT IV.

Physical Characteristics

Screw-terminal wiring

Gauge	copper conductor wire
Wire strip length	of insulation stripped from the end
Temperature rating	
Torque for screw terminals	
Wires per screw terminal	
Ferrules	
Connector securement	
Securement type	Screw flanges provided
Torque for screw flanges	

Hazardous Locations

U.S. (UL)	;
Canada (C-UL)	;

Europe (ATEX) and International (IECEX)

DEMKO ATEX

IECEX

Safety Compliance and Hazardous Locations Standards

This product is designed to meet the requirements of the following electrical equipment safety standards for measurement, control, and laboratory use:

- IEC 61010-1, EN 61010-1
- UL 61010-1, CSA C22.2 No. 61010-1
- EN 60079-0, EN 60079-7
- IEC 60079-0, IEC 60079-7
- UL 60079-0, UL 60079-7
- CSA C22.2 No. 60079-0, CSA C22.2 No. 60079-7

Note For safety certifications, refer to the product label or the [Product Certifications and Declarations](#) section.

Electromagnetic Compatibility

CE Compliance

- 2014/34/EU; Potentially Explosive Atmospheres (ATEX)

Product Certifications and Declarations

Refer to the product Declaration of Conformity (DoC) for additional regulatory compliance information. To obtain product certifications and the DoC for NI products, visit ni.com/product-certifications, search by model number, and click the appropriate link.

Shock and Vibration

To meet these specifications, you must panel mount the system.

Operating vibration	
Random	5 g RMS, 10 Hz to 500 Hz
Sinusoidal	5 g, 10 Hz to 500 Hz
Operating shock	30 g, 11 ms half sine; 50 g, 3 ms half sine; 18 shocks at 6 orientations

Environmental

Refer to the manual for the chassis you are using for more information about meeting these specifications.

Operating temperature (IEC 60068-2-1, IEC 60068-2-2)	-40 °C to 70 °C
Storage temperature (IEC 60068-2-1, IEC 60068-2-2)	-40 °C to 85 °C
Ingress protection	IP40
Operating humidity (IEC 60068-2-30)	10% RH to 90% RH, noncondensing
Storage humidity (IEC 60068-2-30)	5% RH to 95% RH, noncondensing
Pollution Degree	2
Maximum altitude	
NI-9266 with screw terminal	3,000 m
NI-9266 with DSUB	5,000 m

Indoor use only.

Environmental Management

NI is committed to designing and manufacturing products in an environmentally responsible manner. NI recognizes that eliminating certain hazardous substances from our products is beneficial to the environment and to NI customers.

For additional environmental information, refer to the **Engineering a Healthy Planet** web page at ni.com/environment. This page contains the environmental regulations and directives with which NI complies, as well as other environmental information not included in this document.

EU and UK Customers

-  **Waste Electrical and Electronic Equipment (WEEE)**—At the end of the product life cycle, all NI products must be disposed of according to local laws and regulations. For more information about how to recycle NI products in your region, visit ni.com/environment/weee.

电子信息产品污染控制管理办法（中国 RoHS）

-  **中国 RoHS**— NI 符合中国电子信息产品中限制使用某些有害物质指令(RoHS)。关于 NI 中国 RoHS 合规性信息，请登录 ni.com/environment/rohs_china。(For information about China RoHS compliance, go to ni.com/environment/rohs_china.)

Calibration

You can obtain the calibration certificate and information about calibration services for the NI-9266 at ni.com/calibration.

Calibration interval	1 year
----------------------	--------

¹ The maximum voltage a current source can provide to the load.

² Range equals 0 mA to 20.77 mA.

³ Uncalibrated accuracy refers to the accuracy achieved when acquiring in raw or unscaled modes where the calibration constants stored in the module are not applied to the data.

⁴ When the NI-9266 outputs 20 mA into a 600 Ohms user load on all eight channels, 1.92 W are dissipated at the user load.